



Tamil Nadu Road Sector Project - II



Detailed Project Report (DPR) For Various Road Improvement Works under PPC 01 of Tamil Nadu Road Sector Project – II (TNRSP II)



Environmental Management Plan – SH 04 (Revision-2)

September 2014



(A Govt. of India Enterprise)
RITES Bhawan
Plot No. 1, Sector-29,
Gurgaon (Haryana) – 122 001

TABLE OF CONTENTS

CHAPTER - 1: INTRODUCTION	4
1.1 ENVIRONMENTAL ASSESSMENT PROCESS	6
1.2 OBJECTIVES OF ENVIRONMENTAL MANAGEMENT PLAN (EMP)	6
1.3 UNIQUE CHARACTERISTICS OF PROJECT LOCATION – TAMILNADU	7
1.4 ENVIRONMENTAL REGULATIONS APPLICABLE TO THE PROJECT	7
1.5 METHODOLOGY OF PREPARING EMP	8
1.6 DEFINITION OF TERMS USED IN THE PROJECT	9
CHAPTER - 2: PROJECT DESCRIPTION.....	11
2.1. REGIONAL SETTING OF THE PROJECT ROAD	11
2.2. LINK DESCRIPTION.....	11
2.3. PROPOSED PROJECT IMPROVEMENTS.....	11
2.4. ENVIRONMENTAL MANAGEMENT AND ENHANCEMENT MEASURES IN THE PROJECT	26
CHAPTER - 3: ENVIRONMENTAL MANAGEMENT ACTION PLAN	27
CHAPTER - 4: ARRANGEMENTS FOR IMPLEMENTATION OF EMAP	48
4.1. ORGANISATION, STAFFING AND RESPONSIBILITIES OF PMU.....	48
4.2. ORGANISATION, STAFFING AND RESPONSIBILITIES OF CONSTRUCTION SUPERVISING CONSULTANT (CSC).....	51
4.3. ORGANISATION, STAFFING AND RESPONSIBILITIES OF CONSTRUCTION CONTRACTOR.....	54
4.4. INFORMATION DISSEMINATION	55
4.5. GRIEVANCE REDRESSAL MECHANISM	56
4.6. TRAINING PROGRAMME ON ENVIRONMENTAL ASPECTS.....	56
CHAPTER - 5: ENVIRONMENTAL MONITORING AND REPORTING REQUIREMENTS	57
5.1. MONITORING AND REPORTING OF ENVIRONMENTAL MANAGEMENT MEASURES	57
5.2. ENVIRONMENTAL QUALITY MONITORING PLAN FOR THE PROJECT	59
CHAPTER - 6: ENVIRONMENTAL BUDGET	60
6.1. MITIGATION/ENHANCEMENT MEASURES.....	60
6.2. COST ESTIMATES	60
6.2.1. <i>Surface Water Bodies</i>	61
6.2.2. <i>Ground Water Bodies:</i>	61
6.2.3. <i>Sensitive Receptors:</i>	61
6.2.4. <i>Trees</i>	61
6.2.5. <i>Religious/cultural and other Community assets</i>	61
6.2.6. <i>Bus Stops</i>	62

LIST OF TABLES

Table 1.1: Project Roads	4
Table 1.2 : List Of Environmental Regulations Applicable To The Project	7
Table 1.3 : Guidelines In Emap	8
Table 2.1: Environmental Data Sheet	13
Table 3.1: The Environmental Management Action Plan (Emap)	29
Table 4.1 Staffing Pattern In Contractor's Office	52
Table 4.2 Training Programme To The Contractor's Staff	55
Table 6.1: Summary Of Mitigation/Enhancement Measures	59
Table 6.2 : Cost Estimates For Environmental Management	61

LIST OF FIGURES

Fig 1. 1: Index Map	5
Fig 2.1: Regional Setting of the Project Area	12
Fig 4.1: Institutional Organisation of TNRSP for EMP Implementation	47
Fig 4.2: Environmental Management Unit (Emu) Of TNRSP	48
Fig 4.3: Organisation Structure, TNRSP	48

LIST OF ANNEXURES

Annexure 3.1. Guidelines for Siting, Management and Redevelopment of Construction Camps
Annexure 3.2. Guidelines for Siting, Management and Redevelopment of Labour Camps
Annexure 3.3. Guidelines for Siting, Management and Redevelopment of Quarrying and Stone Crushing Operations
Annexure 3. 4. Guidelines for Siting, Management and Redevelopment of Borrow Areas
Annexure 3.5. Guidelines for Siting and Management of Debris Disposal Site
Annexure 3.6. Guidelines For Preparing Comprehensive Waste Management Plan
Annexure 3.7. Guidelines for Top Soil Conservation and Reuse
Annexure 3. 8. Guidelines for Provision of Noise Barriers
Annexure 3.9. Guidelines to Ensure Worker's Safety during Construction
Annexure 3.10. Guidelines for Preparation of Traffic Management Plan
Annexure 3.11. Guidelines for Storage, Handling, Use and Emergency Response For Hazardous Substances
Annexure 3.12 Guidelines for site clearance and tree felling
Annexure 3.13 Guidelines for Soil erosion and sedimentation control
Annexure 3.14 Guidelines for Arrangement with forest department
Annexure 3.15 Guidelines for selection for tree species
Annexure 3.16 Guidelines for environment friendly construction methodology
Annexure 3. 17. Reporting Format for Identification of Construction Camp Site
Annexure 3. 18. Reporting Formats for Identification of Labour Camp Site
Annexure 3. 19. Reporting Format for Identification of Quarry and Stone Crusher Site
Annexure 3. 20. Reporting Format for Identification of Borrow Areas
Annexure 3. 21 Reporting Format for Identification of Debris Disposal Site

- Annexure 3. 22. Reporting Format for Identification of Sources of Water for Construction
- Annexure 3. 23. Format For Register Of Complaints And It's Reporting
- Annexure 3. 24. Format For Register Of Sites Opened And Closed And It's Reporting
- Annexure 3. 25. Checklist for Monitoring Of Construction Camp Management
- Annexure 3. 26. Checklist for Monitoring Of Labour Camp Management
- Annexure 3. 27. Checklist For Monitoring Of Quarry And Stone Crusher Management
- Annexure 3. 28. Checklist for Monitoring Of Borrow Area Management
- Annexure 3. 29. Checklist for the Monitoring Of Debris Disposal Site Management
- Annexure 3. 30. Check List for Monitoring Of Redevelopment of Construction Camp Site
- Annexure 3. 31. Check List for Monitoring Of Redevelopment of Labour Camp Site
- Annexure 3. 32. Check List for Monitoring Of Redevelopment of Quarry and Stone Crusher Site
- Annexure 3. 33. Check List for Monitoring Of Redevelopment of Borrow Areas
- Annexure 3. 34. Check List for Monitoring Of Redevelopment of Debris Disposal Site
- Annexure 3. 35. Reporting Format for Work Force Management
- Annexure 3. 36. Reporting Format for Occupational Health and Safety Measures
- Annexure 3. 37. Reporting Format for Top Soil Conservation
- Annexure 3. 38. Reporting Format for Water Sprinkling For Dust Suppression
- Annexure 3. 39. Reporting Format for Road Safety Measures during Construction
- Annexure 3. 40. Format For Register Of Accidents And It's Reporting
- Annexure 3. 41. Reporting Format for Environmental Quality Monitoring
- Annexure 3. 42. Reporting Format for Enhancement and Mitigation of Cultural Properties
- Annexure 3. 43. Reporting Format for Noise Barrier Construction
- Annexure 3.44. Reporting Format for Enhancement Measures Other Than Cultural Properties
- Annexure 3. 45. Reporting Format for Tree Plantation
- Annexure 3. 46. Reporting Format for Monthly Report from Contractor to CSC
- Annexure 3. 47. Reporting Format for Monthly Report from CSC to PMU
- Annexure 3. 48. List of Permissions to Be Obtained By the Contractor
- Annexure 3. 49. Schematic Diagram of Catch Drain and Oil Interceptors
- Annexure 3. 50. Proposed Chainages of Retaining Wall Location Where Embankment Height Will Be Raised
- Annexure 3. 51. Sensitive Noise Receptors : impact, mitigation and enhancement
- Annexure 3. 52. Water Bodies : Impact, Mitigation and Enhancement
- Annexure 3. 53. Schedule and Specifications for Mitigation and Enhancement Measures
- Annexure 3. 54. Tree Planting and Environmental Enhancement Plan
- Annexure 3. 55. Environmental Enhancement Drawings, BOQ and Cost
- Annexure 3. 56. Cultural Properties : impact, mitigation and enhancement
- Annexure 8.1. Guidelines for monitoring program

CHAPTER - 1: INTRODUCTION

The Government of Tamil Nadu under Tamil Nadu Road Sector Project I (TNRSP I) has improved the State Highways for a length of about 1800 km under various improvement programmes such as up gradation, enhanced periodical maintenance, performance based maintenance and Public Private Partnership. Under Tamil Nadu Road Sector Project II (TNRSP II), about 2100 km of State Highways is taken up for various improvement works. Both TNRSP I and TNRSP II road improvement programmes are under World Bank assistance. The TNRSP II is expected to cover up gradation, maintenance and improvement of the identified core road network. The total cost of the project in TNRSP II is estimated as Rs. 8500 crore approximately having five packages of roads (PPC01 to PPC05). RITES Limited has been awarded the Contract Package: PPC01 in October 2013 for preparation of Detailed Project Report (DPR).

There are 10 roads having a total length of 407.301 km in TNRSP II (PPC 01), out of which 135.327 km is under phase I road are shown in Index Map at **Figure 1.1** highlighted in blue colour and described in **Table 1.1**.

Table 1. 1: Project Roads

S. No.	Project Road Section	Road ID	Chainage		Length (km)
			From	To	
1	Kodambakkam – Sriperumbudur	SH-113	Km 12.500	Km 28.800	16.300
2	Kanchipuram– Vandavasi Road	SH-116	Km 14.115	Km 36.457	22.342
			Km 2.900	Km 14.115	11.215
3	Sadras – Chengalpattu – Kanchipuram – Arakkonam – Tiruthani	SH-58	Km 0.000	Km 26.745	26.745
			Km 26.811	Km 107.350	80.539
4	Chennai – Pulicat	SH-104	Km 0.000	Km 25.500	25.500
5	Arni – Villupuram	SH-4	Km 29.280	Km 115.520	86.240
6	Cheyur – Vandavasi – Polur	SH-115	Km 0.000	Km 105.000	105.000
7	Tambaram-Mudichur-Sriperumbudur Road	SH-110	Km 18.000	Km 23.500	5.500
8	Tiruvotiyur-Ponneri-Pancheti Road	SH-56	Km 15.5000	Km 27.8000	12.300
9	ECR link: Cheyyur-Panayur Road	ODR	Km 0.000	Km 5.000	5.000
10	Pallavaram – Thuraiyakkam Road (six laning)	SH 109	Km 0.000	Km 10.620	10.620
Total					407.301

Note: Road shown in bold letters indicate Phast-I roads under TNRSP-II

The present report on environmental management plan is prepared for SH 04 having a length of 86.24 km in accordance with the World Bank's guidelines to define the Environmental Management requirements to ensure environmental safeguards during construction and operation. This requires World Bank and GOI clearances and approvals before construction can proceed.

The most important parts of this document are that it comprises activity wise impacts and mitigation measures identified for each environmental attribute like land, water, air, noise, biological environment and social environment. A robust Monitoring and Reporting (M&R) system is in-built into it for various phases of the project and activities. This is supported by annexure, which provides (i) detailed guidelines to enable the contractor to implement the EMAP in an appropriate manner, (ii) monitoring formats for the contractor to report to CSC (Construction Supervision Consultant) and (iii) checklists for the CSC to monitor the implementation of EMAP.

FIG 1. 2: INDEX MAP



RAP provides compensation and rehabilitation, for direct (private properties) social impacts, while EMP provides other social impact mitigation and enhancement for direct (public properties) and indirect impacts.

The Link Specific EMAP with its annexure provides specific impacts, mitigation measures and enhancement details.

1.1 ENVIRONMENTAL ASSESSMENT PROCESS

The Environmental Assessment and Environmental Management Plan (EMP) is prepared for Phase-I roads under TNRSP-II in package I (PPC 01) of TNRSP – II. This document addresses the corridor-specific Environmental Management Plan (EMP) for the 86.24 km of Arni - Villupuram road (SH 04) included in the TNRSP-II improvement programme. EIA and EMP reports identify the environmental impacts in the earlier stages of project preparation to incorporate necessary mitigation measures required to minimise those impacts as well as to enhance the positive factors. All environmental management/mitigation costs have been included in the Bill of Quantities (BOQ) titled ‘Environmental impact mitigation works’. In addition to this an environmental monitoring and training budget is included separately as project costs.

The project’s Social Impact Assessments is resulted in the preparation of a Resettlement Action Plan (RAP) for the proposed SH 04 road to address the land acquisition procedures and all associated social aspects such as compensation, resettlement and relocation. Similarly the environmental studies have led to the preparation of project specific EMPs.

This document assists the Contractor and associated officials to mitigate or minimize the negative social and environmental impacts due to the construction and operation of the project and to enhance the positive impact of the project. The EA and EMP have been prepared to meet the GOI requirements as specified by the Ministry of Environment, Forests and Climate Change (MoEFCC) and meeting the requirements of the World Bank. Its purpose is to present an evaluation of potential impacts due to the proposed upgradation and realignment of the existing State Highway from Arni - Villupuram. The document presents the impacts, mitigation measures and appropriate costs for the proposed mitigation measures. The environmental and social impact mitigation and enhancement details of the proposed action within the SH 04 corridor are presented and evaluated in detail in Environmental Assessment and Environmental Management Plan (EMP). Institutional strengthening for environmental management is also an essential part of this document for implementing contract provisions and other environmental mitigation and enhancement provisions.

1.2 OBJECTIVES OF ENVIRONMENTAL MANAGEMENT PLAN (EMP)

The objectives of the Environmental Management Plan (EMP) are to

- Define the Environmental management principles and guidelines for the pre-construction, construction and post construction phases of the road improvement.
- Describe the practical mitigation measures that should be implemented on road improvement works to prevent or mitigate any negative environmental impacts and to enhance the positive issues.

- Establish the roles and responsibilities of all parties involved in the implementation of environmental controls;
- Establish monitoring and reporting system for facilitating appropriate implementation of EMP.

1.3 UNIQUE CHARACTERISTICS OF PROJECT LOCATION – TAMILNADU

Tamil Nadu covers an area of 130,058 km² and is the eleventh largest state in India. The bordering states are Kerala to the west, Karnataka to the North West and Andhra Pradesh to the North. To the east are the Bay of Bengal and the union territory of Pondicherry. Tamil Nadu is the southernmost tip of the Indian Peninsula and has a coastline of about 910 km, the country's third longest coastline. The project is located in a region of low seismic hazard with the exception of the western border areas that lie in a low to moderate hazard zone; as per the 2002 Bureau of Indian Standards (BIS) map. The project area falls in Zones II & III of the seismic zoning map of India.

1.4 ENVIRONMENTAL REGULATIONS APPLICABLE TO THE PROJECT

Summary of environmental clearances/ permits/ approvals required for the project is presented in **Table 1.2**. During the pre-construction stage, the responsibility of obtaining clearances from concerned authority lies with TNRSP. The responsibility of clearances required for construction phase, but prior to work initiation lies with the contractor.

TABLE 1.2: LIST OF ENVIRONMENTAL REGULATIONS APPLICABLE TO THE PROJECT

S. No	Type of Clearance	Statutory Authority	Applicability	Project Stage	Responsibility
1.	Environmental Clearance	MoEF/SEIAA	Not Applicable	Not Applicable	Not Applicable
2.	Forest Clearance for land diversion	Forest Department, TNRSP	Not Applicable	Not Applicable	Not Applicable
3.	Tree felling permission	District Collector	For roadside tree cutting	Pre construction	TNRSP
4.	Explosive License from Chief Controller of Explosives,	Chief Controller of Explosives, petroleum & Explosive Safety Organization	For storing fuel oil, lubricants, diesel etc. at construction camp	Construction stage (Prior to initiation of any work)	The Contractor
5.	Permission for storage of hazardous chemical	CPCB	Manufacture storage and Import of Hazardous Chemical	Construction stage (Prior to initiation of any work)	The Contractor
6.	Quarry Lease Deed and Quarry License	EC from SEIAA and CTE AND CTO from TNPCB and Department of Geology and Mines	Quarry operation (for new quarry)	Construction stage (Prior to initiation of any work)	The Contractor
7.	Permission for extraction of ground	State Ground Water board	Extraction of ground water	Construction stage (Prior to	The Contractor

S. No	Type of Clearance	Statutory Authority	Applicability	Project Stage	Responsibility
	water for use in road construction activities			initiation of any work)	
8.	Permission for use of water for construction purpose	Irrigation Department	Use of surface water for construction	Construction stage (Prior to initiation of any work)	The Contractor
9.	Labour license from	labour commissioner office	Engagement of Labour	Construction stage (Prior to initiation of any work)	The Contractor
10.	Extraction of sand from rivers	District level Expert committee under district collector and local govt. body	Extraction of Sand from rivers	Construction stage (Prior to initiation of any work)	The Contractor

1.5 METHODOLOGY OF PREPARING EMP

Much of the environmental degradation that happens during the construction stage of a highway can be prevented or controlled, if there is an appropriate system in place. Hence, this EMAP has been specifically designed to capture all the impacts that take place during the entire life cycle of a project from design to operation stage. Accordingly, a thorough activity analysis was carried out listing out all the project activities, based on which an impact identification matrix was prepared to understand the impacts upon various environmental parameters such as land, water, air, noise, flora and fauna. Lastly, socio-economic impact upon people and solid waste generation was also considered as separate impacts.

Based on this exercise, a totally new Environmental Management Plan (EMP) has been prepared suggesting various mitigation measures to avoid or minimize the impacts of the project on the environment during the pre-construction, construction and operation phases. Two sets of guidelines were prepared and incorporated in the EMAP table of EMP reports to enable the contractor to implement the project with least impact upon the environment– (i) Guidelines for entire project stretch including the project facilities like camps and sites and (ii) Guidelines exclusively for siting, management and restoration of project facilities like camps and sites.

Table 1.3 gives the list of these guidelines:

TABLE 1.3: GUIDELINES IN EMAP

S. No.	TITLE
A	GUIDELINES FOR ENTIRE PROJECT STRETCH
1.	Guidelines for preparing comprehensive waste management plan
2.	Guidelines for top soil conservation and reuse
3.	Guidelines for Provision of Noise Barriers
4.	Guidelines to Ensure Worker's Safety during Construction
5.	Guidelines for Preparation of Traffic Management Plan
6.	Guidelines for Storage, Handling, Use and Emergency Response For Hazardous Substances
7.	Environmental monitoring plan
B	GUIDELINES FOR PROJECT FACILITIES

1.	Guidelines for siting, management and redevelopment of construction camps
2.	Guidelines for siting, management and redevelopment of labour camps
3.	Guidelines for siting, management and redevelopment of quarrying and stone crushing operations
4.	Guidelines for siting, management and redevelopment of borrow areas
5.	Guidelines for siting and management of debris disposal site

The guidelines for project facilities have been structured with following objectives:

- i. It facilitates the selection of a site with least environmental impact,
- ii. It looks into the satisfaction of the land owner in case of leased out / rental out lands,
- iii. It guides the contractor with step by step measures in setting up of an efficient and environment friendly camp / site,
- iv. It ensure smooth, safe and efficient functioning of these camps and sites,
- v. It guides the contractor in preparing a camp / site management and restoration plan to be submitted to CSC (prior to setting up of the camp/site), and
- vi. It facilitates restoration of the site at the closure stage in a very environment friendly manner.

EMP assigns the responsibilities for various actions identified to limit the adverse impacts of the project. An environmental monitoring plan and an institutional framework have been proposed as part of the EMP for proper implementation and monitoring of mitigation measures. The cost for implementing the proposed environmental mitigation measures and carrying out the environmental monitoring has been worked out and is presented as part of the EMP for necessary budgetary allocations as part of the project cost. In order to implement various environmental requirements during pre-construction, construction and operational phases, all mitigation and enhancement measures have been clearly built in to the Environmental Management Plan. All necessary mitigation and enhancement costs have been part of the BOQ.

1.6 DEFINITION OF TERMS USED IN THE PROJECT

Links: All project roads are identified by link numbers in the Detailed Project Report.

Package: Packages are identified for the purpose of creating attractive construction contracts to National and International Contractors. A package average of 100 km of roads is made up of one or more Links. Contractors may not take interest in a contract if it is not of sufficient size and profitability to merit attention.

ROW: The Right of Way is the land width legally available to the TNRSP. The actual Right of Way can only be established after the legal verification of all adjoining properties. The ROW is often encroached upon on one or both sides. ROW details were not made available to the consultants and were defined by the Client as that area determined by the physical appearance of the existing limits of the Highway, which has been open to the public for unrestricted access over many years. Land Plan Schedule is getting prepared which will avail the existing ROW and land requirement as per the proposed ROW.

Available Corridor: Since the legal ROW details are not available from the TNRSP, the consultants considered the existing corridor width that is physically available as defined above

and referred to it as available corridor for the purpose of project preparation. Land Plan Schedule is getting prepared to avail the legal ROW corridor.

Realignment: Realignment usually refers to an increase in the horizontal curve radius but may be generally applied to any change in the vertical or horizontal alignment of a road.

Bypass: A bypass is the term usually applied to a road, which provides an alternative route around a congested urban area. This usually helps to divert traffic away from the urban centre. Arni bypass is considered in this project.

Private trees: These are trees situated in private properties within the required corridor and which will need to be compensated in monetary terms according to the Resettlement Action Plan.

Public trees: Public trees are those trees that are located within the available corridor of the HD or on a Barren Land (no registered ownership but accounted as land of the Revenue Department).

CHAPTER - 2: PROJECT DESCRIPTION

2.1. REGIONAL SETTING OF THE PROJECT ROAD

Tamil Nadu is the eleventh largest state by area and the sixth most populous state in India. 44 per cent of the state's population live in urban areas, the highest among large states in India. The state was ranked sixth among states in India according to the Human Development Index in 2011. Population density of Tamil Nadu is 555 per sq km which is higher than national average 382 per sq km.

The bordering states of Tamil Nadu are Kerala to the west, Karnataka to the North West, Andhra Pradesh to the North and to the east are the Bay of Bengal and the union territory of Pondicherry.

The project road connects Arni, Chetpet, Gingee and Villupuram. Regional setting of the project road is shown in **Figure 2.1**.

2.2. LINK DESCRIPTION

The project road designated as SH 04 starts at Chainage km 29.280 at Arni and ends at railway crossing in Villupuram district at Chainage km 115.52.

Environmental Data Sheet

Environmental data sheet comprises of chainage wise existing details of environmental and social features, road furniture details, location of cross drainage structures, water body and sensitive receptors details of the corridor (SH 04). **Table 2.1** presents the Environmental Data Sheet for the proposed road SH 04.

2.3. PROPOSED PROJECT IMPROVEMENTS

Study mandates the improvement of the project road to two lane with paved shoulder standards with other improvements to make the road a standard facility. Improvement proposals formulated are based on the IRC guidelines and site specific requirements. The proposed improvements are aimed at easing traffic congestion, reducing the road accidents by improving physical characteristics of the road, which includes geometry, pavement strength, drainage, and enhancing the aesthetics. General philosophy followed in formulating the improvement proposals are:

- Limit the improvements within the land identified for the project.
- Introduce transition to all the curves along the alignment
- Utilize the available Right of Way to the maximum extent possible so as to avoid additional land acquisitions
- Improve and introduce the project facilities
- Improvement of road safety features

FIG 2.1: REGIONAL SETTING OF THE PROJECT AREA

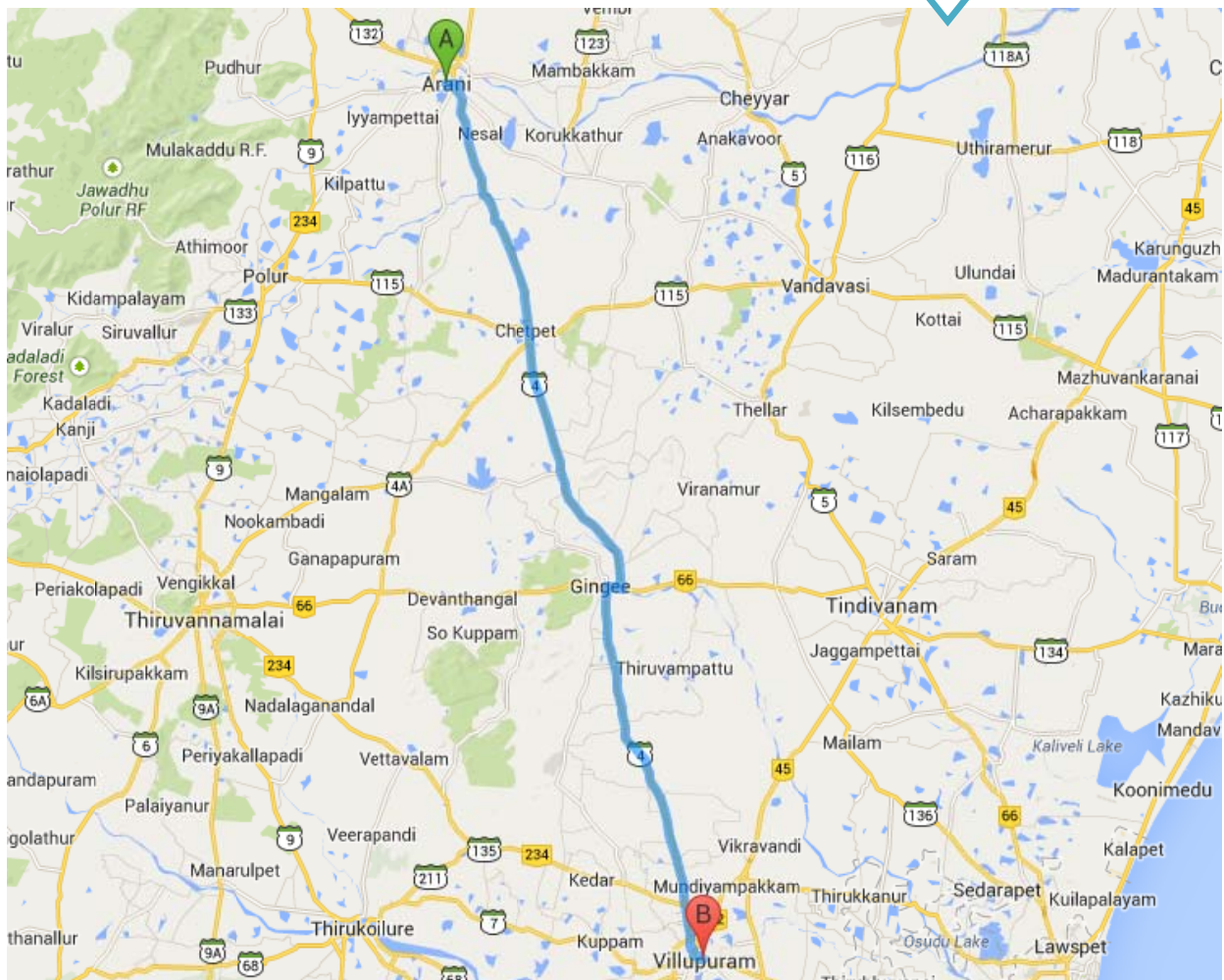
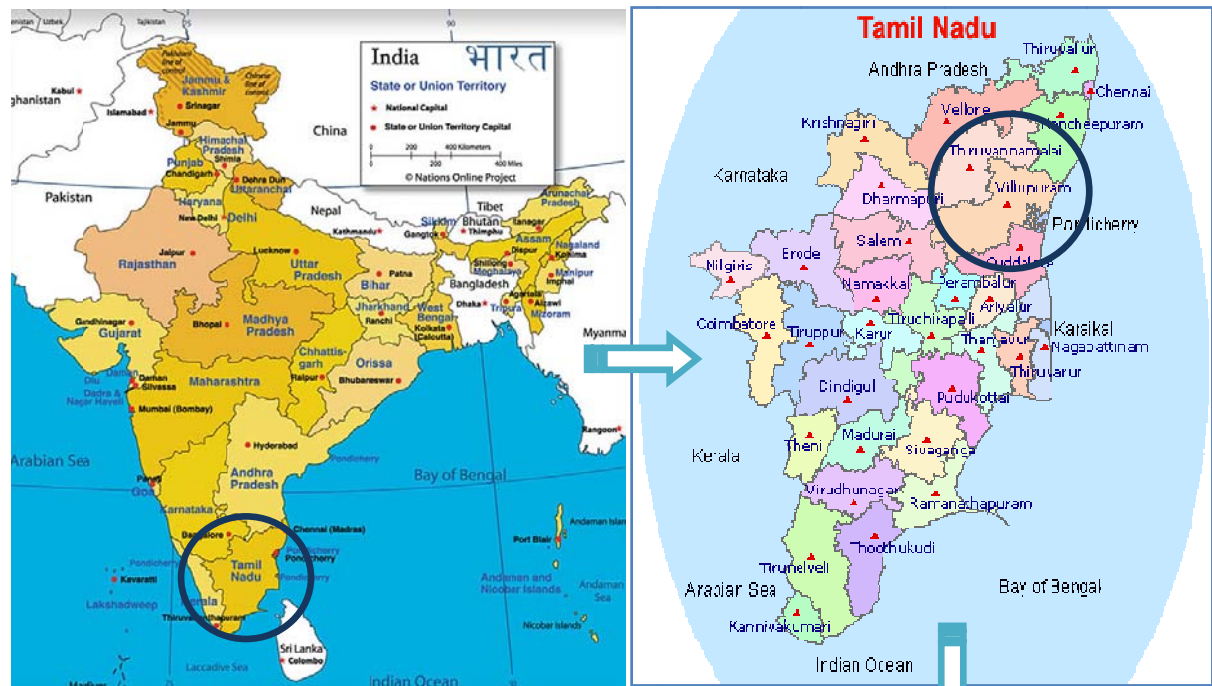

Table 2.1: ENVIRONMENTAL DATA SHEET

Chainage		Environmental and social features		Bus stops	Agriculture, Barren, Residential, Commercial water body/Overhead Tank	Hospitals/Schools/ Crematoria/ Grave Yard
From	To	Left side of the road	Right side of the road			
24.00	25.00	1 Well, 1 School, 4 Temple, 1 Bus Stop, 1 Overhead Tank	3 Temple	1 Bus Stop on LHS	1 Well on LHS 1 Overhead Tank on LHS	1 School on LHS 4 Temple on LHS 3 Temple on RHS
25.00	26.00					
26.00	27.00					
27.00	28.00					
28.00	29.00	1 River, 1 Temple	1 River, 4 Temple			1 River on both side 1 Temple on LHS 4 Temple on RHS
29.00	30.00	1 School, 1 Temple, 1 Mosque A/R/B	2 School, 4 Temple, 1 Mosque A/R/B		A/R/B on LHS A/R/B on RHS	1 School on LHS 2 School on RHS 1 Temple on LHS 4 Temple on RHS 1 Mosque on LHS 1 Mosque on RHS
30.00	31.00	2 School, 1 Temple (Statue), 2 Overhead Tank A/R/B	4 Temple, 1 Bus Stop A/R/B	1 Bus Stop on RHS	2 Overhead Tank on LHS A/R/B on LHS A/R/B on RHS	2 School on LHS 1 Temple on LHS 4 Temple on RHS
31.00	32.00	1 School, 2 Church, 1 Grave Yard A/R	1 Pond, 1 Well, 1 Temple, 1 Overhead Tank A/R		1 Well on LHS 1 Well on RHS 1 Overhead Tank on LHS A/R on LHS A/R on RHS	1 Pond on RHS 1 School on LHS 1 Temple on RHS 2 Church on LHS 1 Grave Yard on LHS
32.00	33.00	1 Well, 1 Church, 1 Grave Yard, 1 Overhead Tank A/R	1 Pond, 1 School, 1 Temple, 1 Overhead Tank A/R		1 Well on LHS 1 Overhead Tank on LHS 1 Overhead Tank on RHS A/R on LHS A/R on RHS	1 Pond on RHS 1 School on RHS 1 Temple on RHS 1 Church on LHS 1 Grave Yard on LHS

Chainage		Environmental and social features		Bus stops	Agriculture, Barren, Residential, Commercial water body/Overhead Tank	Hospitals/Schools/ Crematoria/ Grave Yard
From	To	Left side of the road	Right side of the road			
33.00	34.00	1 Church A/R	1 Temple, 1 Overhead Tank A/R		1 Overhead Tank on RHS A/R on LHS A/R on RHS	1 Temple on RHS 1 Church on LHS
34.00	35.00	1 College, 1 Bus Stop C/R/A	C/R/A	1 Bus Stop on LHS	A/R/A on LHS A/R /A on RHS	1 College on LHS
35.00	36.00	2 School C/R/A	1 Temple C/R/A		A/R/A on LHS A/R /A on RHS	2 School on LHS 1 Temple on RHS
36.00	37.00	C/R/A	2 Temple C/R/A		A/R/A on LHS A/R /A on RHS	2 Temple on RHS
37.00	38.00	1 Hospital, 1 Overhead Tank C/R/A	1 Well, 1 School, 2 Temple, 1 Bus Stop , 1 Overhead Tank C/R/A	1 Bus Stop on RHS	1 Well on RHS 1 Overhead Tank on LHS 1 Overhead Tank on RHS A/R/A on LHS A/R /A on RHS	1 School on RHS 1 Hospital on LHS 2 Temple on RHS
38.00	39.00	1 River, 1 Temple A/R	1 River, 1 Temple A/R/C		A/R on LHS A/R on RHS	1 River on both side 1 Temple on RHS 1 Church on LHS
39.00	40.00	C	1 Temple C		C on LHS C on RHS	1 Temple on RHS
40.00	41.00	2 Pond, 1 Temple, 1 Mosque, 1 Bus Stop , 1 Overhead Tank C	1 Temple C	1 Bus Stop on LHS	1 Overhead Tank on LHS C on LHS C on RHS	2 Pond on LHS 1 Temple on RHS 1 Temple on LHS 1 Mosque on LHS
41.00	42.00	1 Temple C	1 Temple, 1 Bus Stop C	1 Bus Stop on RHS	C on LHS C on RHS	1 Temple on RHS 1 Temple on LHS
42.00	43.00	1 Bus Stop A/B	1 Temple, 1 Overhead Tank A/B	1 Bus Stop on LHS	1 Overhead Tank on RHS A/B on LHS A/B on RHS	1 Temple on RHS
43.00	44.00	1 Pond, 1 Well, 1 School, 1 Temple, 2 Church, 1 Bus	1 Pond, 2 Well, 2 School, 1 Temple, 1	1 Bus Stop on LHS	2 Well on RHS 1 Well on LHS	1 Pond on LHS 1 Pond on RHS

Chainage		Environmental and social features		Bus stops	Agriculture, Barren, Residential, Commercial water body/Overhead Tank	Hospitals/Schools/Crematoria/ Grave Yard
From	To	Left side of the road	Right side of the road			
		Stop , 1 Overhead Tank A/B/R	Overhead Tank A/B/R		1 Overhead Tank on LHS 1 Overhead Tank on RHS A/B /R on LHS A/B /R on RHS	2 School on RHS 1 School on LHS 1 Temple on LHS 2 Church on LHS 1 Temple on RHS
44.00	45.00	2 Well A/B/R	1 Well, 1 Temple A/B/R		1 Well on RHS 2 Well on LHS A/B /R on LHS A/B /R on RHS	1 Temple on RHS
45.00	46.00	2 Well, 1 Overhead Tank	3 Well , 1 Temple		3 Well on RHS 2 Well on LHS 1 Overhead Tank on LHS	1 Temple on RHS
46.00	47.00	4 Temple, 1 Bus Stop	2 Well, 1 Grave Yard	1 Bus Stop on LHS	2 Well on RHS	4 Temple on LHS 1 Grave Yard on RHS
47.00	48.00	2 Well A/B	1 Well, 1 Overhead Tank A/B		1 Well on RHS 2 Well on LHS 1 Overhead Tank on RHS A/B on LHS A/B on RHS	
48.00	49.00	2 Well, 2 Temple A/B	1 Well, 1 Temple A/B		1 Well on RHS 2 Well on LHS A/B on LHS A/B on RHS	1 Temple on LHS 2 Temple on RHS
49.00	50.00	2 Well A/B	1 Aanganwadi Centre, 1 Temple A/B		5 Well on LHS A/B on LHS A/B on RHS	1 Aanganwadi on RHS 1 Temple on RHS
50.00	51.00	A/B	4 Well A/B		4 Well on RHS A/B on LHS A/B on RHS	

Chainage		Environmental and social features		Bus stops	Agriculture, Barren, Residential, Commercial water body/Overhead Tank	Hospitals/Schools/Crematoria/ Grave Yard
From	To	Left side of the road	Right side of the road			
51.00	52.00	2 Well, 1 Temple, 1 Bus Stop A/B	2 Well, 3 Temple A/B	1 Bus Stop on LHS	2 Well on RHS 2 Well on LHS A/B on LHS A/B on RHS	1 Temple on LHS 3 Temple on RHS
52.00	53.00	4 Well, 1 Overhead Tank A/B/R/I	1 Temple, 1 Overhead Tank A/B/R/I		4 Well on LHS 1 Overhead Tank on LHS 1 Overhead Tank on RHS A/B /R/I on LHS A/B/R/I on RHS	1 Temple on RHS
53.00	54.00	1 Well, 1 School, 1 Church, 1 Grave Yard A/B/R/I	1 Well, 1 School, 1 Church A/B/R/I		1 Well on RHS 1 Well on LHS A/B /R/I on LHS A/B/R/I on RHS	1 School on LHS 1 School on RHS 1 Church on LHS 1 Church on RHS 1 Grave Yard on LHS
54.00	55.00	1 Well A/B/R	2 Well, 1 Temple A/B/R		2 Well on RHS 1 Well on LHS A/B /R on LHS A/B/R on RHS	1 Temple on RHS
55.00	56.00	2 Well A/B/R	2 Well, 1 Temple, 1 Bus Stop, 1 Grave Yard A/B/R	1 Bus Stop on RHS	2 Well on RHS 2 Well on LHS A/B /R on LHS A/B/R on RHS	1 Temple on RHS 1 Grave Yard on RHS
56.00	57.00	1 Well, 1 Training Centre, 1 Bus Stop A/B	A/B	1 Bus Stop on LHS	1 Well on LHS A/B on LHS A/B on RHS	1 Training Centre on LHS
57.00	58.00	1 Well, 1 Church A/B/R	1 Well, 1 Grave Yard, 1 Overhead Tank A/B/R		1 Well on RHS 1 Well on LHS 1 Overhead Tank on RHS A/B /R on LHS	1 Church on LHS 1 Grave Yard on RHS

Chainage		Environmental and social features		Bus stops	Agriculture, Barren, Residential, Commercial water body/Overhead Tank	Hospitals/Schools/ Crematoria/ Grave Yard
From	To	Left side of the road	Right side of the road			
					A/B/R on RHS	
58.00	59.00	2 Well B/R	1 Bus Stop B/R	1 Bus Stop on RHS	2 Well on LHS B/R on LHS B/R on RHS	
59.00	60.00	1 Well B/R	2 Pond, 1 Well, 1 Bus Stop , 1 Mandapam B/R	1 Bus Stop on RHS	1 Well on RHS 2 Pond on RHS 1 Well on LHS B/R on LHS B/R on RHS	1 Mandapam on RHS
60.00	61.00	2 Well, 1 Bus Stop B/R	1 Well B/R	1 Bus Stop on LHS	2 Well on LHS 1 Well on RHS B/R on LHS B/R on RHS	
61.00	62.00	4 Well, 1 Church B/R	3 Well, 1 Temple, 1 Bus Stop , 1 Overhead Tank B/R	1 Bus Stop on RHS	4 Well on LHS 3 Well on RHS 1 Overhead Tank on RHS B/R on LHS B/R on RHS	1 Church on LHS 1 Temple on RHS
62.00	63.00	B/R	1 Well, 1 Temple B/R		1 Well on RHS B/R on LHS B/R on RHS	1 Temple on RHS
63.00	64.00	2 Well, 1 School, 1 Bus Stop B/R	2 Well, 1 Hostel, 1 Temple , 1 Overhead Tank B/R	1 Bus Stop on LHS	2 Well on RHS 2 Well on LHS 1 Overhead Tank on RHS B/R on LHS B/R on RHS	1 School on LHS 1 Hostel on RHS 1 Temple on RHS
64.00	65.00	6 Well, 1 Church BRC	1 Pond, 2 Well, 1 Veterinary Hospital BRC		2 Well on RHS 1 Pond on RHS 6 Well on LHS	1 Veterinary Hospital on RHS 1 Church on LHS

Chainage		Environmental and social features		Bus stops	Agriculture, Barren, Residential, Commercial water body/Overhead Tank	Hospitals/Schools/ Crematoria/ Grave Yard
From	To	Left side of the road	Right side of the road			
					B RC on LHS BR C on RHS	
65.00	66.00	1 Pond, 2 Well, 1 Temple, 1 Church, 2 Overhead Tank BRC	2 Well, 2 Temple, 1 Mosque, 1 Bus Stop BRC	1 Bus Stop on RHS	1 Pond on LHS 2 Well on RHS 2 Well on LHS 2 Overhead Tank on LHS B RC on LHS BR C on RHS	2 Temple on RHS 1 Temple on LHS 1 Mosque on RHS 1 Church on LHS
66.00	67.00	4 Well, 1 Grave Yard, 1 Grave Yard + Crematoria A/B/R	4 Well, 1 Temple, 1 Statue, 1 Overhead Tank A/B/R		4 Well on RHS 4 Well on LHS 1 Overhead Tank on RHS A/B/R on LHS A/B/R on RHS	1 Temple on RHS 1 Grave Yard on LHS 1 Grave Yard + Crematoria on LHS 1 Statue on RHS
67.00	68.00	1 Well A/B/R	2 Well, 2 Temple, 1 Bus Stop A/B/R	1 Bus Stop on RHS	2 Well on RHS 1 Well on LHS A/B/R on LHS A/B/R on RHS	2 Temple on RHS
68.00	69.00	2 Grave Yard A/B/R	A/B/R		A/B/R on LHS A/B/R on RHS	2 Grave Yard on LHS
69.00	70.00	A/B/R	1 Bus Stop A/B/R	1 Bus Stop on RHS	A/B/R on LHS A/B/R on RHS	
70.00	71.00	1 Temple, 1 Overhead Tank A/B/R	1 Pond, 1 Bus Stop, 1 Mandapam A/B/R	1 Bus Stop on RHS	1 Pond on RHS 1 Overhead Tank on LHS A/B/R on LHS A/B/R on RHS	1 Temple on LHS 1 Mandapam on RHS
71.00	72.00	1 Pond, 3 Well, 1 Temple, 2 Bus Stop on LHS A/B/R	4 Well, 2 Temple A/B/R	2 Bus Stop on LHS	1 Pond on LHS 4 Well on RHS 3 Well on LHS A/B/R on LHS	2 Temple on RHS 1 Temple on LHS

Chainage		Environmental and social features		Bus stops	Agriculture, Barren, Residential, Commercial water body/Overhead Tank	Hospitals/Schools/ Crematoria/ Grave Yard
From	To	Left side of the road	Right side of the road			
					A/B/R on RHS	
72.00	73.00	2 Well A/B/R	2 Well, 1 School, 1 Overhead Tank A/B/R		2 Well on RHS 2 Well on LHS 1 Overhead Tank on RHS A/B/R on LHS A/B/R on RHS	1 School on RHS
73.00	74.00	1 Temple A/B/R	2 Well A/B/R		2 Well on RHS A/B/R on LHS A/B/R on RHS	1 Temple on LHS
74.00	75.00	1 Well A/B/R	1 School, 1 Temple , 1 Bus Stop A/B/R	1 Bus Stop on RHS	1 Well on LHS A/B/R on LHS A/B/R on RHS	1 School on RHS 1 Temple on RHS
75.00	76.00	1 Grave Yard A/B/R	1 Well, 1 Overhead Tank A/B/R		1 Well on RHS 1 Overhead Tank on RHS A/B/R on LHS A/B/R on RHS	1 Grave Yard on LHS
76.00	77.00	1 Well, 1 Bus Stop A/B/R	1 Well, 2 Temple A/B/R	1 Bus Stop on LHS	1 Well on RHS 1 Well on LHS A/B/R on LHS A/B/R on RHS	2 Temple on RHS
77.00	78.00	1 Well, 1 Temple B/R	1 Well, 2 Temple , 1 Overhead Tank B/R		1 Well on RHS 1 Well on LHS 1 Overhead Tank on RHS B/R on LHS B/R on RHS	2 Temple on RHS 1 Temple on LHS
78.00	79.00	2 Temple	2 Temple			2 Temple on RHS 2 Temple on LHS
79.00	80.00	1 River, 1 School, 1 Temple, 1 Overhead Tank , 1 Grave Yard + Crematoria , 1	1 Hospital, 1 Bus Stop	2 Bus Stop on RHS	1 River both side 1 Overhead Tank on LHS	1 School on LHS 1 Hospital on RHS 1 Temple on LHS

Chainage		Environmental and social features		Bus stops	Agriculture, Barren, Residential, Commercial water body/Overhead Tank	Hospitals/Schools/Crematoria/ Grave Yard
From	To	Left side of the road	Right side of the road			
		Abundant Structure				1 Grave Yard + Crematoria on LHS 1 Abundant Structure on LHS
80.00	81.00	1 School B/C	2 Temple, 1 Church, 1 Overhead Tank B/C		1 Overhead Tank on RHS B/C on LHS B/C on RHS	1 School on LHS 2 Temple on RHS 1 Church on RHS
81.00	82.00	3 Well, 1 Temple, 2 Church B/C	1 Well, 1 Overhead Tank B/C		1 Well on RHS 3 Well on LHS 1 Overhead Tank on RHS B/C on LHS B/C on RHS	1 Temple on LHS 2 Church on LHS
82.00	83.00	4 Well, 1 Temple B/C	1 Well, 1 Bus Stop, 1 Overhead Tank B/C	1 Bus Stop on RHS	1 Well on RHS 4 Well on LHS 1 Overhead Tank on RHS B/C on LHS B/C on RHS	1 Temple on LHS
83.00	84.00	1 Temple, 1 Bus Stop, 1 Overhead Tank B/C	1 Well B/C	1 Bus Stop on LHS	1 Well on RHS 1 Overhead Tank on LHS B/C on LHS B/C on RHS	1 Temple on LHS
84.00	85.00	1 Pond, 1 Temple, 2 Mosque, 1 Bus Stop, 1 Women Development Trust B/C	B/C	1 Bus Stop on LHS	B/C on LHS B/C on RHS	1 Pond on LHS 1 Temple on LHS 2 Mosque on LHS 1 Women Development Trust on LHS
85.00	86.00	1 Pond, 2 Well, 1 Temple, 1 Temple + Bus Stop, 1 Bus Stop + Temple A/B	2 Well A/B		2 Well on RHS 2 Well on LHS A/B on LHS A/B on RHS	1 Pond on LHS 1 Temple on LHS 1 Temple + Bus Stop on LHS

Chainage		Environmental and social features		Bus stops	Agriculture, Barren, Residential, Commercial water body/Overhead Tank	Hospitals/Schools/ Crematoria/ Grave Yard
From	To	Left side of the road	Right side of the road			
						1 Bus Stop + Temple on LHS
86.00	87.00	1 Well, 1 raining Centre, 2 Mosque, 1 Mandapam, 1 Bus Stop, 1 Grave yard + Crematoria A/B	1 Well, 1 School A/B	2 Bus Stop on LHS	1 Well on RHS 1 Well on LHS A/B on LHS A/B on RHS	1 School on RHS 1 raining Centre on LHS 2 Mosque on LHS 1 Mandapam on LHS 1 Grave yard + Crematoria on LHS
87.00	88.00	2 Pond, 1 Mandapam, 1 Temple, 1 Bus Stop A/B	4 Well, A/B	1 Bus Stop on LHS	4 Well on RHS A/B on LHS A/B on RHS	2 Pond on LHS 1 Temple on LHS 1 Mandapam on LHS
88.00	89.00	1 Pond, 2 Well A/B/R	6 Well, 1 Church A/B/R		6 Well on RHS 2 Well on LHS A/B /R on LHS A/B /R on RHS	1 Pond on LHS 1 Church on RHS
89.00	90.00	1 Pond, 1 Bus Stop A/B/R	6 Well, 1 Church, 1 Temple A/B/R	1 Bus Stop on LHS	1 Well on RHS A/B /R on LHS A/B /R on RHS	1 Pond on LHS 1 Church on RHS 1 Temple on RHS
90.00	91.00	1 Church, 1 Temple, 1 Grave yard A/B/R	1 Pond, 1 School, 1 Mandapam, 1 Temple + Statue A/B/R		A/B /R on LHS A/B /R on RHS	1 Pond on RHS 1 School on RHS 1 Church on LHS 1 Temple on LHS 1 Mandapam on RHS 1 Temple + Statue on RHS 1 Grave yard on LHS
91.00	92.00	1 Pond, 2 Well, 1 Temple, 1 Grave yard, 2 Overhead Tank	3 Well, 1 Bus Stop, B/R	1 Bus Stop on RHS	3 Well on RHS 2 Well on LHS B /R on LHS	1 Pond on LHS 1 Temple on LHS 1 Grave yard on LHS

Chainage		Environmental and social features		Bus stops	Agriculture, Barren, Residential, Commercial water body/Overhead Tank	Hospitals/Schools/ Crematoria/ Grave Yard
From	To	Left side of the road	Right side of the road			
		B/R			B /R on RHS	2 Overhead Tank on LHS
92.00	93.00	2 Well, 1 Bus Stop B/R	2 Well B/R	1 Bus Stop on LHS	2 Well on RHS 2 Well on LHS B /R on LHS B /R on RHS	
93.00	94.00	2 Well BCR	1 Well, 1 Bus Stop BCR	1 Bus Stop on RHS	1 Well on RHS 2 Well on LHS B CR on LHS B CR on RHS	
94.00	95.00	1 Pond, 1 Crematoria BRC	1 Grave Yard BRC		B RC on LHS B RC on RHS	1 Pond on LHS 1 Crematoria on LHS 1 Grave Yard on RHS
95.00	96.00	1 School, 1 (Church+ School+ Hospital) 1 Temple, 2 Bus Stop , 1 Grave Yard, 1 Overhead Tank BRC	1 Hostel, 1 Church, 1 Grave Yard BRC BRC	2 Bus Stop on LHS	1 Overhead Tank on LHS B RC on LHS B RC on RHS	1 School on LHS 1 Hostel on RHS 1 (Church+School+Hospital) on LHS 1 Temple on LHS 1 Church on RHS 1 Grave Yard on LHS 1 Grave Yard on RHS
96.00	97.00	ABCR	2 Pond, 3 Well, 1 Bus Stop ABCR	1 Bus Stop on RHS	3 Well on RHS ABCR on LHS ABCR on RHS	2 Pond on RHS
97.00	98.00	1 Pond, 1 Well, 3 Temple ABCR	1 Well, 1 Temple, 1 Bus Stop on ABCR	2 Bus Stop on RHS	1 Well on RHS 1 Well on LHS ABCR on LHS ABCR on RHS	1 Pond on LHS 3 Temple on LHS 1 Temple on RHS
98.00	99.00	1 Well, 1 Bus Stop ABCR	2 Well, 1 School, 1 Church, 1 Overhead	1 Bus Stop on LHS	2 Well on RHS 1 Well on LHS	1 School on RHS 1 Church on RHS

Chainage		Environmental and social features		Bus stops	Agriculture, Barren, Residential, Commercial water body/Overhead Tank	Hospitals/Schools/ Crematoria/ Grave Yard
From	To	Left side of the road	Right side of the road			
			Tank ABCR		1 Overhead Tank on RHS ABCR on LHS ABCR on RHS	
99.00	100.00	1 Well, 1 School, 3 Temple, 1 Overhead Tank ABR	1 Well, 1 Church, 1 Bus Stop ABR	1 Bus Stop on RHS	1 Well on RHS 1 Well on LHS 1 Overhead Tank on LHS ABR on LHS ABR on RHS	1 School on LHS 3 Temple on LHS 1 Church on RHS
100.00	101.00	1 Overhead Tank ABR	1 Well ABR		1 Well on RHS 1 Overhead Tank on LHS ABR on LHS ABR on RHS	
101.00	102.00	1 Pond, 1 School, 1 Sacred Groove, 1 Church, 1 Temple ABR	2 Well, 1 ITI, 2 Church, 1 Bus Stop ABR	1 Bus Stop on RHS	2 Well on RHS ABR on LHS ABR on RHS	1 Pond on LHS 1 School on LHS 1 ITI on RHS 1 Sacred Groove on LHS 2 Church on RHS 1 Church on LHS 1 Temple on LHS
102.00	103.00	1 Sacred Groove, 1 Bus Stop ABR	1 Hospital, 1 Bus Stop ABR	1 Bus Stop on LHS 1 Bus Stop on RHS	ABR on LHS ABR on RHS	1 Hospital on RHS 1 Sacred Groove on LHS
103.00	104.00	2 Pond, 3 Well, 2 Temple, 1 Bus Stop ABR	1 Well, 1 Overhead Tank ABR	1 Bus Stop on LHS	1 Well on RHS 3 Well on LHS 1 Overhead Tank on RHS ABR on LHS ABR on RHS	2 Pond on LHS 2 Temple on RHS
104.00	105.00	ABR	ABR		ABR on LHS ABR on RHS	
105.00	106.00	ABR	1 Bus Stop	1 Bus Stop on RHS	ABR on LHS	

Chainage		Environmental and social features		Bus stops	Agriculture, Barren, Residential, Commercial water body/Overhead Tank	Hospitals/Schools/ Crematoria/ Grave Yard
From	To	Left side of the road	Right side of the road			
			ABR		ABR on RHS	
106.00	107.00	2 School, 3 Temple, 1 Temple (3 Nos.), 1 Mosque, 1 Bus Stop, 2 Overhead Tank ABR	1 Bus Stop, 1 Grave Yard ABR	1 Bus Stop on LHS 1 Bus Stop on RHS	2 Overhead Tank on LHS ABR on LHS ABR on RHS	2 School on LHS 3 Temple on LHS 1 Mosque on LHS 1 Temple (3 Nos.) on LHS 1 Grave Yard on RHS
107.00	108.00	2 Pond, 1 School, 4 Temple, 2 Overhead Tank ABR	1 Well, 1 School, 3 Temple, 1 Church, 1 Bus Stop ABR	1 Bus Stop on RHS	1 Well on RHS 2 Overhead Tank on LHS ABR on LHS ABR on RHS	2 Pond on LHS 1 School on LHS 1 School on RHS 4 Temple on LHS 3 Temple on RHS 1 Church on RHS
108.00	109.00	1 Pond, 1 Temple ABR	1 Temple (in college) ABR		ABR on LHS ABR on RHS	1 Pond on LHS 1 Temple (in college) in RHS 4 Temple on LHS
109.00	110.00	1 Pond, 1 Well, 2 School, 1 Temple, 1 Overhead Tank ABR	1 (College + Mosque), 1 Mosque, 1 Bus Stop ABR	1 Bus Stop on RHS	1 Well on LHS 1 Overhead Tank on LHS ABR on LHS ABR on RHS	1 Pond on LHS 2 School on LHS 1 (College + Mosque) on RHS 1 Temple on LHS 1 Mosque on RHS
110.00	111.00	1 Pond, 1 Crematoria ABR	1 Temple, 1 Bus Stop, 1 Overhead Tank ABR	1 Bus Stop on RHS	1 Overhead Tank on RHS ABR on LHS ABR on RHS	1 Pond on LHS 1 Temple on RHS 1 Crematoria on LHS
111.00	112.00	ABR	ABR		ABR on LHS ABR on RHS	
112.00	113.00	1 Overhead Tank 1 Grave Yard ABR	1 Well, 1 School, 2 Temple, 2 Bus Stop ABR	2 Bus Stop on RHS	1 Well on RHS 1 Overhead Tank on LHS ABR on LHS	1 School on RHS 2 Temple on RHS 1 Grave Yard on LHS

Chainage		Environmental and social features		Bus stops	Agriculture, Barren, Residential, Commercial water body/Overhead Tank	Hospitals/Schools/ Crematoria/ Grave Yard
From	To	Left side of the road	Right side of the road			
					ABR on RHS	
113.00	114.00	1 School, 3 Temple, 1 Temple (2 Nos.), 1 Crematoria, 1 Overhead Tank ABR	2 Bus Stop, 1 Overhead Tank ABR	2 Bus Stop on RHS	1 Overhead Tank on LHS 1 Overhead Tank on RHS ABR on LHS ABR on RHS	1 School on LHS 3 Temple on LHS 1 Temple (2 Nos) on LHS 1 Crematoria on LHS
114.00	115.00	1 Mosque ABR	ABR		ABR on LHS ABR on RHS	1 Mosque on LHS
115.00	116.00	1 Railway Line BCR	BCR	1 Railway Line on LHS	BCR on LHS BCR on RHS	

Source: - Data collected by RITES Team Note – A: Agriculture, B: Barren, R: Residential, C: Commercial, I: Irrigated

Accordingly, the following optimum level of improvements is proposed:

- Widening of the project road as the traffic warrants;
- Strengthening/reconstruction of the existing pavement for the entire length;
- Provision of footpath cum built-up drain at built-up and industrial locations;
- Improving/redesigning sharp curves;
- Widening/reconstruction of existing culverts and provision of additional culverts depending on the cross drainage requirements;
- Bridge and cross drainage rehabilitation, widening and reconstruction.
- Junction improvements;
- Provision for pedestrian crossing facilities;
- Provision of traffic signs and road furniture;
- Provision of bus shelters and
- tree plantation

2.4. ENVIRONMENTAL MANAGEMENT AND ENHANCEMENT MEASURES IN THE PROJECT

General environmental enhancement measures proposed for the project are construction of retaining wall, construction of boundary wall, provision planting trees on the inner side of the sound insulating wall as noise barrier at sensitive locations, planting trees on both sides of the road at places where land is available, etc. Apart from this, public utilities such as construction of bus shelters and bus bays will be undertaken along the project corridor. Guidelines for siting, management and redevelopment of construction camps, labour camps, quarrying and stone crushing operations, borrow areas, debris disposal site are described in Annexure 3.1 to Annexure 3.5 while guidelines for waste management plan, top soil conservation and reuse, noise barriers, worker's safety during construction, traffic management plan, storage, handling, management and emergency response for hazardous substances, site clearance, selection of tree species and environment friendly construction methodology are given in Annexure 3.6 to Annexure 3.16.

The environmental impact mitigation measures and enhancement measures proposed are covered under EMAP (Refer Table 3.1) and the environmental enhancement drawings, BOQ and Costare provided as Annexure 3.55. The tree planting and environmental enhancement plan are provided in Annexure 3.54. Guidelines for monitoring program given in Annexure 8.1 of Chapter 8 of EA report is reproduced here again for quick reference.

CHAPTER - 3: ENVIRONMENTAL MANAGEMENT ACTION PLAN

Environmental mitigation measures have been incorporated within the design process, including the avoidance of potential impacts through changes in the alignment and other means. Appropriate measures have also been identified for action in the construction and operational phases. Environmental Management Action Plan (EMAP) tabulates the measures identified for all phases i.e. the design, pre-construction, construction and operational phases identifying the nature of the potential environmental impact, their mitigation measures, the implementing agency and responsible organisation and where appropriate, the contractual clause or reference. EMAP is given in Table 3.1.

The role and responsibility of the organisations mentioned in the table are mentioned below.

State Pollution Control Board (SPCB): The State Pollution Control Board will be responsible for any matters related to air, water and noise pollution during construction and operational stages. Any matters related to this may be brought under their notice for solution.

Forest Department: Any matters related to social forestry, forests, wildlife and trees etc should be consulted with the local DFO or Forest Range Officer, Forest Department depending upon the advice required.

PMU and HD: PMU will be available only in the State head quarters at Chennai. Most of the work in the local level will be taken care of at the local HD level throughout Tamil Nadu.

Final Design Consultant: Preparation of final road designs and contract documentation is based on the preliminary road designs and the formulation of the Environmental Management Plan and Environmental Management Action Plan recommendations.

Environmental Specialist of PMU: ES will be responsible for all matters of environmental monitoring and inter Governmental co-ordination.

Traffic Police and State Police: Any matters related to traffic and violation of traffic and other law and order issues may be taken up with the traffic police and State Police.

Tamil Nadu Water Supply and Drainage Board (TWAD) : TWAD will be responsible for any matters relating to water supply, water taps, bore wells and tube wells along the sides of the roads.

Irrigation Department: The irrigation department will be responsible for all matters relating to rivers, canals, waterways and irrigation canals.

Local bodies (Panchayat and Municipal Authorities): Panchayat and Municipal authorities will be responsible for local bus waiting sheds, Panchayat and municipal public wells etc.

Motor Vehicle Department: The motor vehicle department will be responsible for the issue and matters relating to Pollution under Control Certificates, driving licences etc.

Fire Force and Fire Station: The matters relating to safety especially relating to fire safety may be taken up with the Fire force.

Archaeological Department: All matters relating to ancient archaeological structures and historical monuments that may encounter during construction works or identified during pre-construction stage.

Mining and Geology Department: All matters relating to quarry and sand materials may be referred to State Mining and Geology Department.

Penalty for Non-conformity to EMP

Clause No.	Description
Protection of the Environment	<p>The Contractor shall implement all mitigation measures for which responsibility is assigned to him as stipulated in the EMP Report. Any lapse in implementing the same will attract the penalty clause as detailed below:</p> <ol style="list-style-type: none"> 1. All lapse in obtaining clearances / permissions under statutory regulations and violations of any regulations with regard to eco-sensitive areas shall be treated as a major lapse. 2. Any complaints of public, within the scope of the Contractor, formally registered with the CSC, or with the PWD complaint cell and communicated to the contractor, which is not properly addressed within the time period intimated by the CSC / PMU shall be treated as a major lapse. 3. Non-conformity to any of the mitigation measures stipulated in the EMP Report (other than stated above) shall be considered as a minor lapse. 4. On observing any lapses, CSC shall issue a notice to the Contractor, to rectify the same. 5. Any minor lapse for which notice was issued and not rectified, first and second reminders shall be given after one month from the original notice date and first reminder date respectively. Any minor lapse, which is not rectified, shall be treated as a major lapse from the date of issuing the second reminder. 6. If a major lapse is not rectified upon receiving the notice, CSC shall invoke the penalty clause, in the subsequent interim payment certificate. 7. Penalty for major lapses shall be with-holding of 10% of the interim payment certificate, subject to a maximum limit of Rs. 30 lakhs. 8. If the lapse is not rectified within three months after withholding the payment, the amount withheld shall be forfeited. 9. CSC shall submit the progress of work to Project Implementation Unit (PIU) on monthly basis. If progress of work is not found satisfactory, CSC issues notice in triplicate duly signed by Environmental Specialist. One copy is for TNRSP, CSC own file and one copy for Contractor. Receipt of the notice is signed by the contractor for the record purpose.

Public Participation

The participation of local people during field study was included in the study by conducting consultations discussing various issues concerning to the project. These consultations were done along the corridor which helped in conducting the public consultation in an organised way as described below.



Some of the findings collected are as described below.

1. People were concerned about the impact on environment with respect to tree loss
2. Majority of tree is tamarind and livelihood of local people is dependent on it.
3. People were found concerned about the impact on common facility like hand pump, tube wells, overhead tanks etc..
4. People were found enthusiastic for development works of road and expressed all sorts of support during construction of the project, but suggested to minimize the social issues at the most.

Structured Public Consultations

Project Level Structured Public Consultation was conducted at 2 locations i.e. Lakshmipuram and Gengaiasodamani (Chetpet). Consultations were accomplished to collect the opinion/views on the project. At pre-scheduled date and venue, people were communicated to gather for consultation with the help of gram panchayat. Gathering was explained about the project activities and their consequences in brief. Queries of the participants were replied by the Consultant experts and at the same time their suggestions were also recorded.

During the public consultation issues on trees, public utilities, community structures, employment and pollution during construction were discussed. Issue raised and suggestions given by the public is presented below. Photographs showing public consultation are shown in Figure.

Summary of structured Public Consultation

Location	Issues	Suggestions of Stakeholders	Mitigation Measures	
Lakshmipuram (SH-4)	Ecology	Trees on both side of road are tamarind trees which are socio-economic importance.	To minimise the tree loss, one side road widening has been taken into consideration.	
	Pollution	No pollution problem to the villagers	Pollution level will be kept at minimal level by adopting mitigation measures.	
	Amenities	Service road near village		Slow moving vehicle lane is proposed to be provided in paved shoulder.
		Approach road to the Sugar factory which is 4 km from SH-4.		This is world bank funded project, approach road to sugar factory will be constructed by highway department.
		Service road to the newly build Handicap School which is likely to be opened in the coming month.		This is world bank funded project, approach road to sugar factory will be constructed by highway department.
School at Thumbur village where about 1500 students studying gets affected.		Noise barrier and road safety measures		

Location	Issues	Suggestions of Stakeholders	Mitigation Measures
		Temple, water tank, bus stand at Thumbur village gets affected.	These will be rehabilitated appropriately in time.
Gengaiasodamani Village (SH-4)	Pollution	No pollution problem to the villagers due to proposed development	
		No issue of noise during construction	Proper maintenance of equipment and machinery produces noise level within limit.
	Amenities	Disturbance to hospitals & pipeline of water tank along the road side.	Signages for no horn zone at hospital location and water tank will be suitably relocated.
		Widen the road on patta land to avoid the structures along the road side.	One side widening is proposed wherever feasible
	Traffic	More accidents at present which get reduced due to proposed road.	The road are getting upgraded as per IRC guidelines
		Requirement of divider at centre of the road	Road divider will be provided where four laning is proposed.



Lakshmipuram



Gengaiasodamani Village (Chetpet)

Table 3.1: The Environmental Management Action Plan (EMAP)

Environmental Impact & Issues	Mitigation/Enhancement measures	Time frame	Organisation	Responsible Organisation	Reference/Contractual Clause
DESIGN PHASE					
General consideration of Cross section Alternatives	Standard cross section alternatives were used for the Project of road design depending on the traffic requirement and economic indicators.	During Design	PIU – TNRSP	Design Consultant	Not applicable in EA report
Geometric Design	The proposed alignment is selected/adjusted (within IRC/MoRTH specifications) - to minimize land disturbance - to avoid culturally & environmentally sensitive areas – cultural properties, water bodies etc.	During alignment design	PIU – TNRSP	Design Consultant	Not applicable in EA report
Issues from stakeholder Consultations	Various issues raised were examined & suitably incorporated based on merit & other road safety measures.	During Design	PIU - TNRSP	Design Consultants	Chapter 5 EA Report
Avoidance of Cultural Properties	-No cultural properties along the alignment were identified. -Religious Structures were avoided by adjustment of alignment to the extent possible	During alignment design	PIU – TNRSP	Design Consultants, Contractor	Engineering Report, DPR
Preservation of tree	Eccentric widening proposed	During alignment design	TNRSP, Department of Forest, TN.	Design Consultants, Contractor	Engineering Report, DPR
Design Discharge & Drainage design	As per MoRTH	During Design	TNRSP	Design Consultants, Contractor	Not applicable in EIA report
Monitoring at critical locations	The monitoring of Air, land, water and Noise has been carried out at critical locations along the project corridor. This will serve as a benchmark for monitoring during construction and operational phases. (Appendix 8.1: Monitoring Plan)	During Design	TNRSP	Design Consultants	Chapter 4: EA Report
Orientation of	A comprehensive planning/orientation schedule has been	During Design	TNRSP	Design	Not applicable in

Environmental Impact & Issues	Mitigation/Enhancement measures	Time frame	Organisation	Responsible Organisation	Reference/Contractual Clause
Implementing Agency	prepared at different stages for TNRSP.			Consultants	EA report
External Influence of construction camp	Location and basic facilities at site are suggested in a way to cause minimum interference with the local system, for details refer Annexure 3.1: Guidelines for siting & layout of construction camp	During Design	TNRSP	Design Consultants, Contractor	Annexure 3.1 EMP Report
Diversion of Traffic	Appropriate diversion of traffic schemes to ensure smooth traffic flow, minimize accidents during construction, design of diversionary signage	During Design	PIU - TNRSP	Design Consultants, Contractor	Engineering Report, DPR and Annexure 3.10 of EMP
Accident black spot	Improved road surface with improved road geometry, Pedestrian facilities and Bus shelters is planned. Lining and signing is given a high priority for all road junctions. Safety Audits completed on the final design drawing and corrective measures undertaken.	During design Stage.	PIU - TNRSP Traffic Police	Design Consultants Traffic Police Contractor	Engineering Report, DPR
PRE-CONSTRUCTION PHASE					
Permissions/ Approvals	Application for Tree felling permission to be submitted to Forest Department, GoTN/Other local Authority	After centreline marking at site.	Department Forest, TN	of PIU	Annexure 3.12 EMP Report
	Application for Forest Land diversion (Not applicable for SH 04)	After centreline marking at site.	Department Forest, TN	of PIU, Design Consultants	
Land Acquisition	The land acquisition to be done as per 'Right to Fair Compensation and Transparency in Land Acquisition, Rehabilitation and Resettlement Act, 2013'	After proposed centreline marking at site	TNRSP, Revenue Department	PIU, Land Acquisition Officer (LAO-TNRSP)	RAP/DPR
Property Acquisition	- Compensation to be paid to Project Affected Peoples based on the Resettlement Action Plan.	Post design to Pre-construction.	TNRSP, Revenue Department, NGOs recommended in	PIU R&R Officer (TNRSP),	RAP/DPR

Environmental Impact & Issues	Mitigation/Enhancement measures	Time frame	Organisation	Responsible Organisation	Reference/Contractual Clause
RAP					
Relocation of Utilities	All community underground and over head utilities are to be shifted as per <u>utility shifting plan</u> , prior permission should be obtained from regional offices of Electricity, Telecommunications, OFC, Water works etc.	Post design to Pre-construction	TNRSP	PIU – R&R Design Consultant, Contractor	Engineering Report, DPR
Loss of Irrigation water source (surface water)	Mitigation/enhancement measures proposed in EA report	Post design to Pre-construction.	TNRSP surface Water Board /PHED	PIU, Contractor	EA & EMP Report
Loss of Irrigation water source (Ground water)	Financial compensation proposed	Post design to Pre-construction.	TNRSP Ground Water Board /PHED	PIU, Contractor	EMP Report
Tree Felling	Tree felling permission to be obtained from Forest Department, GoTN/Other local Authority	Post design to Pre-construction.	TNRSP ,Department of Forest, TN	EMU, Contractor	3.2.3, Chapter 3 EA Report
Religious/Cultural Properties	Mitigation/Enhancement measures have been proposed. There is no cultural properties along the corridor getting affected	Pre Construction	PIU – TNRSP	Contractor	8.7.1.1 chapter-8, EA report.
Noise Sensitive Receptors	Mitigation & Enhancement measures proposed.	During design stage.	PIU – TNRSP	Contractor	8.5.1 chapter-8, EA report.
Existing Bus Stop	Replacement Bus stop/ New Bus bays are proposed	During design stage.	PIU – TNRSP Transport corporation, Highway Dept.	Contractor	Refer clause 2.8 chapter-2, EA report.
CONSTRUCTION PHASE					
Clearances, Approvals and Permits	List of clearance and Activity Type of Clearance Explosive License from Chief	Required prior to start of construction Applicability For storing fuel oil,	Construction stage (Prior to initiation of any work	TNRSP, SPCB, CPCB, Chief Controller of Explosives,	The Contractor General Conditions of Contract

Environmental Impact & Issues	Mitigation/Enhancement measures	Time frame	Organisation	Responsible Organisation	Reference/Contractual Clause
	Controller of Explosives, lubricants, diesel etc. Permission for storage of hazardous chemical from CPCB Borrow Area, approval from district collector, Consent letter, lease agreement with the owner of land. Quarry Lease Deed and Quarry License from State Department of Mines and Geology Permission for extraction of ground water for use in road construction activities from State Ground Water board Permission for use of water for construction purpose from irrigation department Labour license from labour commissioner office	Manufacture storage and Import of Hazardous Chemical Borrow area for excavation of earth Quarry operation (for new quarry) Extraction of ground water Use of surface water for construction Engagement of Labour	District Collector State department of Mines and Geology, State Ground Water Board, State Irrigation Department, Labour commissioner officer, Contractor		Clause 111.3, MoRTH
	Provide a copy of all necessary clearances to the PMC / EMU ➤ Adhere to all clearance terms and conditions ➤ Obtain written permission from private landholders to conduct construction activities on their land prior to commencing works.				
Environmental Management And Monitoring Facility Equipment	Monitoring is to be carried out regularly as per the frequency and locations mentioned in Annexure 5.1.	During and after construction	SPCB, PIU - Contractor TNRSP		Annexure 8.1.

Environmental Impact & Issues	Mitigation/Enhancement measures	Time frame	Organisation	Responsible Organisation	Reference/Contractual Clause
for EMP (Meters, Vehicles and Buildings)					
Asphalting	Asphalt mixing plants should be sited over 1000 m from any communities. Mixing equipment should be well sealed, and be equipped with a dust-removal device. Operators should wear dust masks, ear protection and hard hats.	During Construction	PIU- TNRSP, Contractor	Contractor	MORTH Specification 111, 111.5
AIR					
Gaseous Emissions	Vehicles and machinery are to be maintained so that emissions conform to National Ambient air quality standards. All vehicles and machineries should obtain <u>Pollution Under Control Certificates</u>	Beginning with & throughout construction	PIU - TNRSP, SPCB, Contractor	Contractor	MORTH Specification 111.1, 111.5
Dust Generation	<ul style="list-style-type: none"> ➤ Vehicles delivering materials should be covered to reduce spills and dust blowing off the load. ➤ Clearing and grubbing to be done, just before the start of next activity on that site. In case of time gap, water should be sprinkled regularly till the start of next activity. ➤ Water to be sprayed during the construction phase, at mixing sites, approach roads & temporary roads. ➤ In laying sub-base, water spraying is needed to aid compaction of the material. After the compaction, water spraying should be carried out at regular intervals to prevent dust generation. ➤ Road surface should be cleaned with air compressor and vacuum cleaners prior to the construction works. Manual labour using brooms should be avoided, if used labour to be provided masks. ➤ Embankment slopes to be covered with turfing/stone pitching immediately after completion 	Beginning with & throughout construction until asphalting is completed and side slopes are covered.	PIU – TNRSP, Contractor	Contractor	MORTH Specification 111.1, 111.5, 111.8, 111.9, 111.10
Equipment Selection	Construction plant and equipment will meet recognized	During	PIU – TNRSP,	Contractor	MORTH Spec

Environmental Impact & Issues	Mitigation/Enhancement measures	Time frame	Organisation	Responsible Organisation	Reference/Contractual Clause
maintenance and operation	international standards for emissions and will be maintained and operated in a manner that ensures that relevant air, noise, and discharge regulations are met	construction	EMU – TNRSP, Contractor		106, IRC: 72-1978; IRC: 90-1985, 111.5, 111.9, 111.10, 201.3
LAND					
Soil Erosion and Sedimentation control	<p>Main reason of soil erosion is rains/monsoon, contractor should plan the activities so that NO bare/ loose earth surface is left out before the onset of monsoon, for minimizing the soil erosion following preventive measures to be taken such as</p> <ul style="list-style-type: none"> ➤ Embankment slopes to be covered, soon after completion ➤ Next layer/activity to be planned, soon after completion of, clearing and grubbing, laying of embankment layer, sub grade layer, sub-base layer, scarification etc. ➤ Top soil from borrow area, Debris disposal sites; borrow area, construction site to be protected/covered for soil erosion. ➤ Debris due to excavation of foundation, dismantling of existing cross drainage structure will be removed from the water course immediately. ➤ Diversions for bridges will be removed from the water course before the onset of monsoon. 	<p>Upon completion of construction activities at these sites. During construction</p>	<p>PIU – TNRSP, Contractor</p> <p>of EMU – TNRSP, Contractor</p>	Contractor	MoRTH Specification 306, 307, 308
Loss of agricultural topsoil	<p>All areas of cutting and all areas to be permanently covered will be stripped to a depth of 150mm and stored in stockpile. Top soil will be safeguard from erosion and will be reused as follows.</p> <ul style="list-style-type: none"> ➤ Covering all borrow areas after excavation is over. ➤ Dressing of slopes of road embankment ➤ Agricultural field, acquired temporarily. 	During construction	<p>PIU – TNRSP</p> <p>EMU – TNRSP, Contractor</p>	Contractor	MORTH Specification 301.3.2, 305.3.3
Compaction of Soil	Construction vehicles should operate within the Corridor of	During	PIU – TNRSP	Contractor	MORTH

Environmental Impact & Issues	Mitigation/Enhancement measures	Time frame	Organisation	Responsible Organisation	Reference/Contractual Clause
and Damage to Vegetation	Impact avoiding damage to soil and vegetation. Diversions, access road used will be redeveloped by contractor, to the satisfaction of the owner/villagers.	construction	EMU – TNRSP, Contractor		Specification 201.2
Contamination of soil	Guidelines of “Hazardous waste (management and handling) rules, 1989 will be enforced. <ul style="list-style-type: none"> ➤ Plant to be setup 500m away from surface water body. ➤ Oil interceptor will be installed at construction site. ➤ Septic tank will be constructed for safe disposal of waste. ➤ EH & S guidelines will be followed to avoid contamination of soil and safe disposal of hazardous material 	During Construction	PIU – TNRSP Contractor EMU – TNRSP, Contractor		7.4.5, Chapter 7, EA Report
Borrow pits	NO borrow pit will be opened without the permission of supervision consultant. <ul style="list-style-type: none"> ➤ Written approval from owner to be submitted to EMU. ➤ Borrow pits have been identified outside the ROW. ➤ Identification of borrow areas outside the ROW. Before opening additional borrow pits operating pits shall be closed as per the IRC Specification ➤ Identification of borrow areas with consent of the Environmental Expert confirming to the quality standards. ➤ Borrow areas shall preferably be selected from high land and/or waste land, where farmers are willing to lower their area for cultivation purposes. ➤ Enforceable provisions in contractual arrangements for opening and use of material borrow pits. ➤ Consent to operate after signing of formal agreement ➤ Additional borrow pits not to be opened without the restoration of those areas no longer in use. ➤ Measures taken for rehabilitation of the borrow areas 	During Construction	PIU – TNRSP Contractor EMU – TNRSP, Contractor		IRC: 10 1961 MoRTH Spec. 111.2, 305.2.2, 301; 305.2.2.2; 305.4, 1002 Annexure 3.4: guidelines for borrow area management

Environmental Impact & Issues	Mitigation/Enhancement measures	Time frame	Organisation	Responsible Organisation	Reference/Contractual Clause
Quarry operations	<ul style="list-style-type: none"> ➤ Quarrying will be carried out at approved and licensed quarries only. Copy of licenses to be submitted to the EMU. ➤ Extraction of materials from designated quarries after consent of Department of Mining and District Administration ➤ Development of Quarry Redevelopment Plan 	During Construction	PIU – TNRSP EMU – TNRSP, Contractor	Contractor	MoRTH Specification 111.3, 302, 305.2.2, 117;118; 1002 Annexure 3.3 EMP Report.
Material sources	<p>As far as possible contractor will use the approved material sources.</p> <p>In case on new quarry the instruction of Annexure 3.3: Guidelines for Aggregate Quarry Management will be applicable.</p>				
WATER					
Loss of water bodies (Surface/Ground)	<ul style="list-style-type: none"> ➤ Mitigation measures for loss of water bodies recommended ➤ NO excavation from the bund of the water bodies. ➤ NO debris disposal near, any water body. ➤ Prior written permission from authorities for use of water for construction activity should be submitted to EMU. ➤ Construction labours should be restricted from polluting the source or misusing the source. ➤ Shifting of source to be completed prior to disruption of the actual source. ➤ Source (potable or otherwise) such as wells, ponds or tube – well, etc to be replaced immediately, in case of accidental loss. ➤ Alternate measures to be taken/ensured during disrupted period. ➤ The location and sifting of the replaced source of water 	During Construction	PIU – TNRSP Irrigation Dept, Contractor	Contractor	MORTH Specification 111.4, 201.2, 301, 304, 306 8.4.1, Chapter 8, EA Report.

Environmental Impact & Issues	Mitigation/Enhancement measures	Time frame	Organisation	Responsible Organisation	Reference/Contractual Clause
	shall be as per design or as directed by the Engineer. ➤ In general, there should be only lateral displacement				
Alteration of drainage	➤ Diversions should be constructed during dry season, with adequate drainage facility, and will be completely removed before the onset of monsoon. ➤ Debris generated due to the excavation of foundation or due to the dismantling of existing structure should be removed from the water course. ➤ Silt fencing has to be provided on the mouth of discharge into natural streams. ➤ Continuous drain (lined/unlined) is provided, obstruction if any, to be removed immediately.	Whenever encountered during construction.	PIU – TNRSP, Contractor Irrigation Dept.		MORTH Specification 201.2,301, 306, 312 Chapter-2 EA report, Engineering Report, DPR
Runoff, drainage and Flood control on site	➤ Throughout continuous drain is provided. ➤ Lined drain is provided at built-up locations for quick drainage. ➤ Provision of adequately sized drainage structures at regular intervals in flood-prone areas and at crossing points (e.g. intermittent streams). ➤ Erosion Augmentation of existing drainage and cross drainage (CD) structures ➤ Measures to prevent blockage to natural drainage pattern due to stacking of construction materials. ➤ Adequate facilities of drainage at construction site and camp in order to avoid stagnant water pools that also lead to soil	During Construction	PIU – TNRSP, Contractor Contractor		MORTH Specification 305.3.7; 309; 309.3.6; 311.1; 311.2; 312.1; 312.2
Construction water availability	➤ Contractor has to provide list of sources (surface/ground) for approval from EMU. ➤ Prior to use of source contractor should obtain the written permission from authority, to use the water in construction activity, and submit a copy to EMU.	During Construction	PIU – TNRSP EMU –TNRSP, Contractor	Contractor	MORTH Specification 601.2.4 1010

Environmental Impact & Issues	Mitigation/Enhancement measures	Time frame	Organisation	Responsible Organisation	Reference/Contractual Clause
	<ul style="list-style-type: none"> ➤ During construction only permitted quantity (permission taken) from approved sources should be used in construction activity. ➤ Water bodies shall not be used for drawing or disposal of water during construction. ➤ Water should be clean and free from injurious substances. ➤ Make availability of adequate water supply and its source before construction. ➤ Consent from authority to dig new tube-well. ➤ Steps for minimization of water wastage during construction. 				
Silting/sedimentation	<ul style="list-style-type: none"> ➤ Measures suggested under “Soil Erosion and Sedimentation control” have to be enforced. ➤ Silt fencing should be provided around water bodies. ➤ Construction activities should be stopped near water bodies during monsoon. 	Throughout construction period.	PIU – TNRSP, Irrigation Dept., Forest Dept.	Contractor	MORTH Specification 111.4, 306
Contamination of water	<ul style="list-style-type: none"> ➤ Measures suggested under “Contamination of soil” have to be enforced. ➤ Construction work close to water bodies should be avoided during monsoon. ➤ Labour camps are to be located away from water bodies. ➤ Car washing/workshops near water bodies are to be avoided. 	Throughout construction period.	PIU – TNRSP, EMU – TNRSP, SPCB, Irrigation Dept, Contractor	Contractor	MORTH Specification 111.1, 111.4, 111.9, 111.13, 122, 201.2, 201.4, 301.1.3.10, 304.3.3, 306
NOISE					
Noise	<ul style="list-style-type: none"> ➤ Noise standard at processing sites, e.g. aggregate crushing plants, batching plant, hot mix plant are to be strictly monitored to prevent exceeding of GOI noise standards. ➤ Inventory of all equipments / machinery to be used by the 	Beginning and throughout construction	PIU – TNRSP, C, SPCB, Contractor	Contractor	MORTH Specification 111, 111.5

Environmental Impact & Issues	Mitigation/Enhancement measures	Time frame	Organisation	Responsible Organisation	Reference/Contractual Clause
	contractor along with their PUC certificates, specifications. ➤ Workers in the vicinity of strong noise to wear protectors and their working time should be limited as a safety measure. ➤ In construction sites within 150 m of sensitive receptors construction to be stopped from 22:00 to 06:00. ➤ Machinery and vehicles should be maintained to keep their noise to a minimum. ➤ Noise barrier in terms of wall & plantation is proposed at noise sensitive locations.				8.5.1, Chapter 8, EA Report.
FLORA & FAUNA					
Loss of trees and Avenue Planting	➤ Avenue plantation has to be taken up soon after completion of civil works. ➤ Community structures has to be enhanced with plantation ➤ Pressure on trees due to increase in fuel demand from labour be minimized by providing alternate source of fuel like kerosene and LPG at subsidised cost.	After completion of construction activities	PIU – TNRSP, Forest Dept.	Contractor	MORTH Specification, 111, 111.5, 201.5, 306, 308 8.5.1 & 8.6.3 Chapter 8, EA Report.
Vegetation clearance	➤ Clearing and grubbing should be avoided beyond that which is directly required for construction activities. ➤ Next activity to be planned/started immediately, to avoid dust generation and soil erosion during monsoon. ➤ Turfing / re-vegetation to be started soon after completion of embankment.	During cleaning operations During construction	PIU – TNRSP, Forest Dept. Contractor	Contractor	MORTH Specification 201.2
Fauna	➤ Construction workers must protect natural resources & wild animals. ➤ Hunting will be prohibited. ➤ Nesting grounds & migratory paths will be protected.	During construction	PIU – TNRSP, Forest Dept, Contractor	Contractor	MORTH Specification 111.1, 111.6

SOCIO-ECONOMIC ENVIRONMENT

Environmental Impact & Issues	Mitigation/Enhancement measures	Time frame	Organisation	Responsible Organisation	Reference/Contractual Clause
General Issues		During Construction	PIU – TNRSP,	Contractor	MORTH Specification 111, 111.5, 111.6, 112, 201.2, 201.3 & 201, 302, 306
Fear of uncertainties regarding future	<ul style="list-style-type: none"> ➤ Public participation sessions were/will be conducted in different stages of project construction. 				
Public Health and Safety	<ul style="list-style-type: none"> ➤ Debris, so generated will be disposed to the satisfaction of Engineer. ➤ Monitoring of air, water, noise and land during construction and operation phase. 				
Labour Camps	<ul style="list-style-type: none"> ➤ Approval of Environment Expert for setting up of camp facility. ➤ Contractors should recruit the local people as labourers at least for unskilled and semi-skilled jobs. ➤ Hygiene and basic facilities should be ensured at labour camp to prevent the spread of disease. ➤ Provision of Public health facilities such as drinking water, sanitation and toilets. ➤ Awareness programmes on communicable diseases ➤ Proper sewerage disposal system for labour camps. ➤ Provision of first aid facilities, Day Crèche Facilities ➤ Sitting of construction camps away from water bodies forests/protected areas/ settlements 				Annexure 3.2
Allied activities	Detailed traffic control plans shall be prepared and submitted to the engineer for approval 5 days prior to commencement of work on any section of road.				
Accidents and Safety	The contractor should provide, erect and maintain barricades, including signs marking flags lights and flagmen as required by the Engineer.				

Environmental Impact & Issues	Mitigation/Enhancement measures	Time frame	Organisation	Responsible Organisation	Reference/Contractual Clause
Religious/ Cultural Community Structures/Sensitive Noise receptors	<ul style="list-style-type: none"> ➤ A comprehensive mitigation/enhancement plan is prepared for each of the existing community properties along the project corridor ➤ Precautions should be taken during construction, for accidental loss/damage of any communal property. ➤ Any loss during construction will be the sole responsibility of contractor and the damage will be repaired immediately up to the satisfaction of people, at contractor's own cost. ➤ Through access/identification should be maintained during construction. 	During construction	PIU – TNRSP,	Contractor	8.7.1.1 chapter-8, EA report. 8.5.1 chapter-8, EA report.
Road side amenities	<ul style="list-style-type: none"> ➤ Bus shelter will be proposed at all built-up locations, in case already existing; the same will be repaired and rehabilitated. ➤ Pedestrian crossing is provided at major pedestrian crossings, providing zebra crossing, sign posts and speed breakers. 	During construction	PIU – TNRSP,	Contractor	Engineering Report, DPR
ROAD SAFETY					
Accident with hazardous materials	<p>COMPLIANCE with “Rules” as defined in Environmental (Protection) Act, 1986, including:</p> <ul style="list-style-type: none"> ➤ For delivery of hazardous substances, three certificates issued by transportation department are required permit license, driving license, and guarding license. ➤ Vehicles delivering hazardous substances will be printed with standard signs. ➤ Public security, transportation and fire fighting departments will designate a special route for these vehicles. 	During Construction	TNRSP, Police Station, EMU	State Contractor, local Fire bodies	Annexure 3.11 EMP Report

Environmental Impact & Issues	Mitigation/Enhancement measures	Time frame	Organisation	Responsible Organisation	Reference/Contractual Clause
	<ul style="list-style-type: none"> ➤ These vehicles can only be parked at designated parking lots. ➤ In case of spill of hazardous materials, relevant departments will be informed at once & dealt with it in accordance with spill contingency plan. 				
OPERATIONAL PHASE					
AIR					
Dust Generation	<ul style="list-style-type: none"> ➤ Avenue plantation to be maintained, casualties to be replaced. ➤ Avenue plantation includes species having dust absorption characteristic. ➤ Dust generation due to vehicle wheel will be reduced due to increased/widened paved surface. ➤ Maintenance of roads to be ensured. 	After completion of construction activity	PIU-TNRSP, SPCB, Contractor	Contractor	8.2, Chapter 8, EA Report
Air Pollution	<ul style="list-style-type: none"> ➤ Air pollution monitoring program has been devised for checking pollution level and suggesting remedial measures. ➤ With the reduction in journey time, idle engine running time air pollution will reduce. ➤ Avenues plantation is proposed throughout the corridor, casualties to be replaced. ➤ Avenue plantation includes species having air purifying characteristic. ➤ Enforce Pollution Under Control (PUC) Programs. The public will be informed about the regulations on air pollution of vehicles. ➤ Transport vehicles and other equipment shall conform to emission standards fixed by Statutory Agencies of Government of India or the State Government from time to time 	After completion of construction activity	EMU, SPCB of Forest Dept, State Transport Dept., Traffic Police, Contractor	Contractor	8.2, Chapter 8, EA Report.

LAND

Environmental Impact & Issues	Mitigation/Enhancement measures	Time frame	Organisation	Responsible Organisation	Reference/Contractual Clause
Temporary land acquisition	<ul style="list-style-type: none"> ➤ Borrow area redevelopment plan to be completed/enforced. ➤ All temporary acquired land for construction of diversion, transportation of material etc should be redeveloped to the satisfaction of owner. ➤ Affected productive area to be poured with top soil. 	After completion of construction	EMU, SPCB, Contractor	Contractor	Annexure 3.4, EMP Report & Engineering Report, DPR
Soil erosion	<ul style="list-style-type: none"> ➤ Embankment slopes to be re-vegetated, casualties to be replaced. ➤ Residual spoils to be disposed properly. 	After completion of construction	EMU, SPCB, Contractor	Contractor	Annexure 3.13 EMP Report & Engineering Report, DPR
Soil Contamination	<ul style="list-style-type: none"> ➤ Accidental spills are potentially disastrous, but its probability is quite low as one of the objectives of this project is to enhance road safety. ➤ The public should be informed about the regulations on land pollution. ➤ Monitoring of Land pollution to be done regularly as per frequency and location mentioned in Appendix 8.1 and suggesting remedial measures. 	After completion of construction	EMU, SPCB, State Police, State Transport Dept., Contractor	Contractor	8.3.5 Chapter 8, EA Report Annexure 8.1 EMP Report
WATER					
Silting/sedimentation	<ul style="list-style-type: none"> ➤ Measures suggested under “soil erosion” to be enforced. ➤ De-silting of existing water bodies to be taken up. ➤ Silt fencing to be provided. 	After completion of construction	EMU, SPCB	Contractor	Annexure 3.13 EMP Report, Engineering Report, DPR
Contamination of water	<ul style="list-style-type: none"> ➤ Discouraging local people from establishing workshops and car wash near public drinking water source. ➤ The public to be informed about the regulations on water pollution. ➤ Monitoring of water pollution to be done regularly as per frequency and location mentioned in Appendix 8.1 and suggesting remedial measures. 	After completion of construction	EMU, SPCB, State Police, State Transport Dept. respective Municipal Agency	Contractor	Annexure 3.6 EMP Report

Environmental Impact & Issues	Mitigation/Enhancement measures	Time frame	Organisation	Responsible Organisation	Reference/Contractual Clause
Maintenance of Storm Drainage System	The urban drainage systems should be maintained to accommodate storm water flow. Cleaning/removing of spoils should be ensured before/during rains the monsoon rains.	Especially at the start & end of rains	EMU, respective Municipal Agency	Contractor	Engineering Report, DPR
NOISE					
Noise	<ul style="list-style-type: none"> ➤ HORN PROHIBITED sign post will be enforced. ➤ Maintenance of noise barriers. ➤ Discouraging local people from establishing sensitive receptor near the road. ➤ The public to be informed about the regulations on noise pollution. ➤ Monitoring of noise pollution to be done regularly as per frequency and location mentioned in Appendix 8.1 and suggesting remedial measures. 	After completion of construction	SPCB, Traffic Police, State Transport Dept.	Contractor	Annexure 3.8 EMP Report, Engineering Report, DPR
FLORA & FAUNA					
Loss of trees and Avenue Planting	<ul style="list-style-type: none"> ➤ The avenue plantation should be completed, maintained and casualties to be replaced. ➤ Discouraging local peoples from cutting tree/branches for fuel, cattle food etc. ➤ Educating people about the usefulness of trees. 	After completion of construction	EMU-TNRSP, Forest dept.	Contractor	Annexure 3.54, EMP Report
SOCIO-ECONOMIC ENVIRONMENT					
General issues	<ul style="list-style-type: none"> ➤ Public consultation to be organized after completion of construction to access the people opinion/grievances from the project intervention. ➤ Remedial measures to mitigate the impact due to project intervention to be incorporated in the operation phase. 	Operation phase	TNRSP, EMU	Contractor	NIL
Religious/Cultural structures & Noise Sensitive receptors	<ul style="list-style-type: none"> ➤ The mitigation/enhancement measures to be completed, and trees to be maintained and casualties to be replaced. 	During Maintenance period of Highway	EMU	Contractor	Annexure 3.56, EMP Report

Environmental Impact & Issues	Mitigation/Enhancement measures	Time frame	Organisation	Responsible Organisation	Reference/Contractual Clause
ROAD SAFETY					
Protection of high road embankments	<ul style="list-style-type: none"> ➤ Stabilization of altered (especially high embankment.) embankments. ➤ Although stone pitching is provided, vigilance to be maintained. 	Immediately after construction	TNRSP	Contractor	Engineering Report
Safety and noise disturbance	<ul style="list-style-type: none"> ➤ New buildings are prohibited within 50 m of the edge of carriageway. ➤ No new schools and hospitals are allowed within 200 m of carriageway. Wherever required appropriate noise barrier should be constructed. 	Throughout and after project development period	Local Bodies	Local Bodies, Contractor	IRC 35-1971 IRC 79-1981 IRC 93-1995
Accident black spot	<ul style="list-style-type: none"> ➤ Road surface to be maintained, pot holes to be filled immediately. ➤ Regular maintenance of sign post, painting/removal of bills. ➤ Road marking to be maintained. ➤ People to be educated about the safety in following traffic rules. ➤ Speed limit to be enforced at sensitive locations. ➤ Lighting of major junctions near settlements. ➤ Mitigative /preventive measures for accident black spots, like traffic calming devises. 	During Operational stage.	TNRSP, Local Bodies	Contractor	Engineering Report, DPR

¹ PMC: Project Management/Supervision Consultant, PIU: Project Implementation Unit, EMU: Environmental Management Unit
 Revision Level: R2

CHAPTER - 4: ARRANGEMENTS FOR IMPLEMENTATION OF EMAP

The Environmental Management Action Plan (EMAP) (Refer Table 3.1), which is an integral part of the Environmental Management Plan, identify the detailed impacts, propose the mitigation actions and mention the implementing organization and monitoring organization. The responsibility for the implementation of EMP is assigned to a number of parties, each with specific responsibilities. They are listed as follows:

- Project Management Unit (PMU), that represents GoTN and is directly responsible for implementing the project
- Construction Supervising Consultant (CSC), who will be in charge of supervising the Contractor
- Construction Contractor, who is in charge of undertaking road construction work and environmental management plan works.

This chapter looks into the organisation and staffing of each of these stakeholders along with their responsibilities.

4.1. ORGANISATION, STAFFING AND RESPONSIBILITIES OF PMU

Project Management Unit (PMU) for the project under scrutiny is TNRSP, which is a part of the Highway Department(HD) in general, as the project proponents, are responsible for the implementation of all road improvement works and environmental management activities. The TNRSP is executing the project work under the guidance of Project Director (PD) as its head. The Project Director is assisted on all technical issues by one Chief Engineer (Projects), one Superintendent Engineer, one Executive Engineer (Environment) and sociologist and Assistant Executive Engineer and Assistant Engineers. The PMU is having five field divisions comprising of one Executive Engineer (R&R Officer), 2 Assistant Executive Engineers and 9 Assistant Engineers and other supporting staff which will play a key role in implementation of EMP and R&R. The team will oversee the project related management activities of the project including the overall control of construction activities and implementation of contracts.

The implementation of mitigating measures requires supervision from adequately trained staff within the HD. The institutional organisation for EMP implementation is shown in Figure 4.1 and Figure 4.2 shows a very flexible and practical Environmental Management Unit (EMU). The detailed structure of TNRSP is separately captured in Figure 4.3.

Responsibilities of Chief Engineer in HD : S/he is responsible for acquisition of all necessary right-of-way (ROW) land and buildings, review and approval of detailed road designs, obtaining all necessary clearances for construction and related activities, review and approval of the road re-alignments and road works (including retaining walls and excavation sites) and liasoning with supervision consultants.

Responsibilities of Environmental Specialist: The Environmental Specialist (ES) of TNRSP Project Management Unit (PMU) assists the Chief Engineer in the overseeing of environmental aspects of the construction contracts, including the enforcement of all monitoring provisions, and advice on the locations of construction and labour camps, etc. He is also familiar with the Indian environmental legislation, environmental monitoring, EMP implementation aspects

etc. The Environmental engineer shall oversee day to day implementation of the environmental management plans pertaining to the construction contract for various roads and is also responsible for monitoring reports to World Bank. Additional recruitment if needed will be undertaken as necessary on contract basis.

FIG 4.1. INSTITUTIONAL ORGANISATION OF TNRSP FOR EMP IMPLEMENTATION

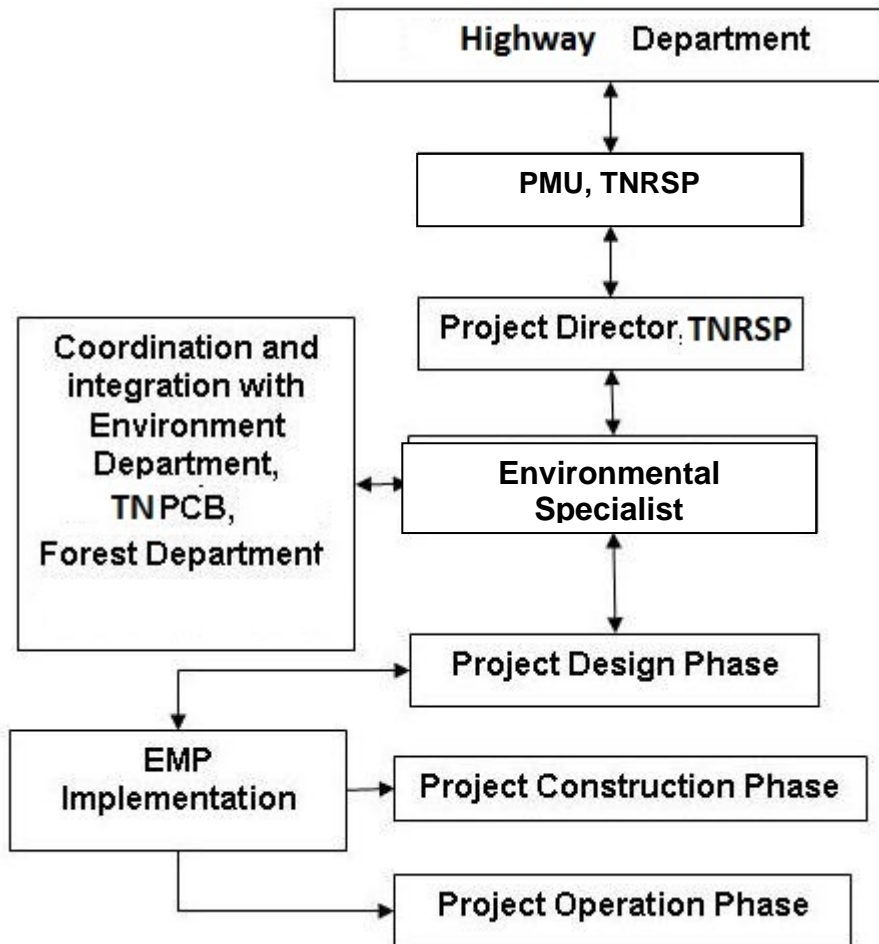

FIG 4.2. ENVIRONMENTAL MANAGEMENT UNIT (EMU) OF TNRSP

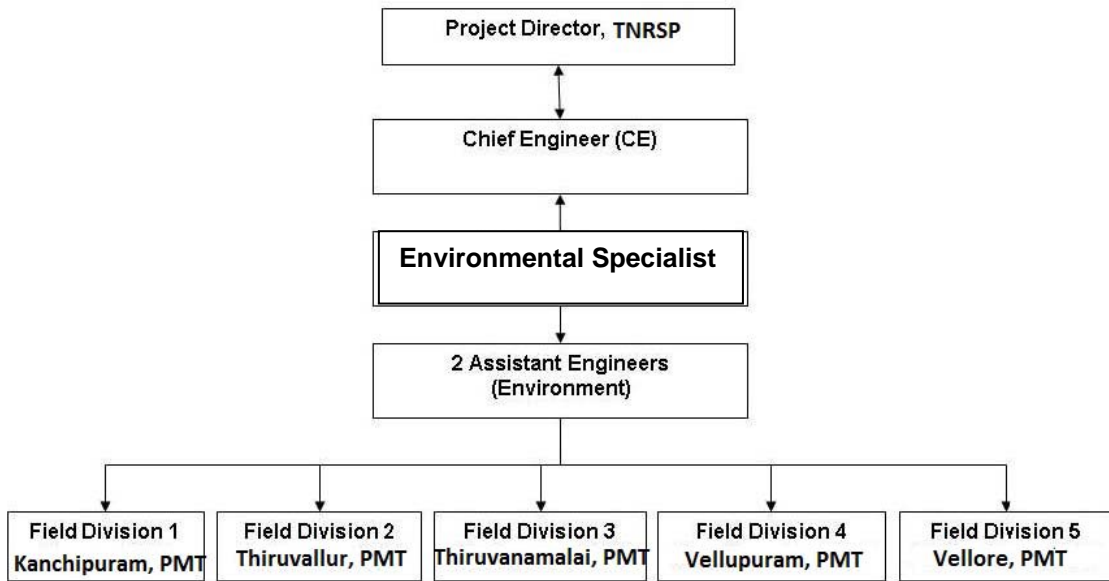
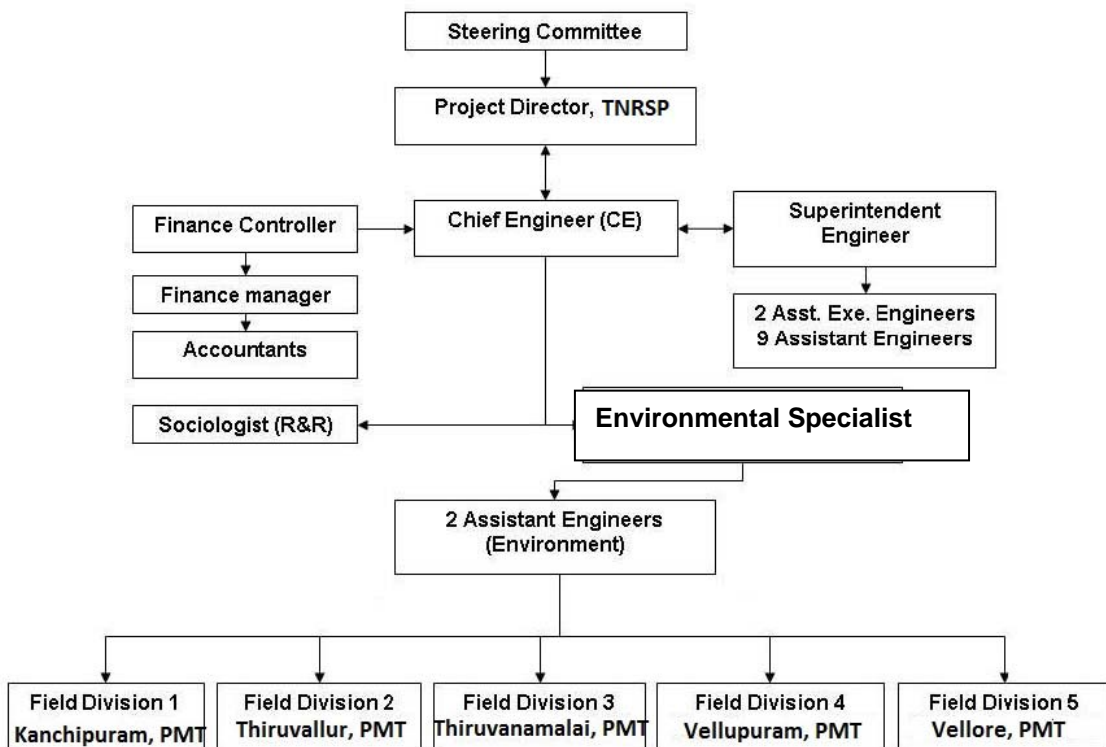

FIG 4.3. ORGANISATION STRUCTURE, TNRSP



The main duties of the Environmental Specialist will include:

- Collection and dissemination of relevant environmental documents including amendments to environmental protection acts issued by the Government and agencies such as the World Bank, Asian Development Bank (ADB) and other organisations.
- Co-ordination with community groups, government departments, etc. on environmental issues and obtaining the necessary clearances from the regulatory authorities.
- Monitoring the environmental aspects of the project during construction to ensure that the environmental requirements of the contract and the mitigation measures proposed in the EMP are implemented.
- Advising Engineer and preparing environmental input for monthly progress report.
- Development of guidelines or a code of good practice on low-cost environmental measures that can be implemented in the road construction and maintenance programs for the Highway Department.
- Assistance to local governments in the restoration of the environmentally degraded portions of any existing Right-of-Way, which may revert to their control due to the construction of realignments.
- Promotion of the policies adopted for the development of roadside amenities
- Assistance with the road safety components and issues related to the effects of roadside environment on road safety and non-motorised traffic.
- Liaison with the EO of CSC and report to Superintending Engineer on all matters related to implementation of the Environmental Management Plan.
- Issuing completion certificate for constructed road works for payment.

4.2. ORGANISATION, STAFFING AND RESPONSIBILITIES OF CONSTRUCTION SUPERVISING CONSULTANT (CSC)

The Supervising Consultant will supervise the activities of the construction Contractor on behalf of Tamil Nadu State Highway Department and will be reporting directly to the Superintending Engineer. The Supervising Consultant will be responsible for the technical supervision of road layout, overseeing contract implementation and certifying works for payment.

The roles of Construction Supervision Consultant are described below:

- Supervision of the Contractor to ensure that work is undertaken according to the construction contract.
- Inspection and reporting of Contractor activities to ensure effective implementation of the EMP.
- Auditing of Contractor works and activities against conditions put forward in the EMP.
- Issuing corrective action, requests and conduct follow up inspections and evaluation.
- Reporting any exceptions to the Project Director.
- Certifying completed constructed road works for payment.

The CSC shall have all the required specialists including an Environmental officer (EO) and a Senior Construction Safety Specialist. The brief description of qualifications, duties and responsibilities of the Team Leader, Senior Construction Safety Specialist and Environmental Officer of the Construction Supervision Consultants (CSC) are as follows:

Qualifications, roles and responsibilities of Team Leader: He shall be at least a graduate in Civil Engineering, with at least at least 20 years of professional experience out of which he should have worked as Team Leader/Project Manager or equivalent for minimum 4 years on supervision/construction of highway projects, preferably involving flexible pavements. Post Graduate qualification in civil engineering is desirable. His roles and responsibilities shall be as follows:

- He will be overall in-charge of the project supervision team.
- He shall be responsible for the overall implementation activities.
- He shall be assisted by key Professionals and other support Staff.
- He shall co-ordinate with the sub-ordinate team to ensure that the construction process is well controlled as per established procedures.
- He will interact with the client.

Qualifications, roles and responsibilities of Senior Construction Safety Specialist (SCSS): The candidate shall be at least a Graduate in civil engineering and preferably with post graduate qualification in Industrial and Construction safety. OSHAS certification will be mandatory. S/he needs a minimum of 10 years of relevant professional experience, out of which, s/he should have worked for at least 5 years at a road / bridge construction site in the capacity of a safety engineer. Experience in working on height / deep foundations and live traffic situation and imparting safety training to construction managers and workers will be highly desirable.

- The SCSS will report to the Team leader of the Construction Supervision Team.
- S/he will be responsible for reviewing and approving the construction zone safety plans and traffic management including all temporary works/staging along with the structural or bridge engineer to confirm the safety point of view.
- The Safety Specialist will be responsible to guide the field supervision team and contractors site officers and should confirm whether safety measurements implemented in the field are complying with safety standards.
- The safety specialist must report any job accident or safety violation to the concerned officials through team leader. When an employee is injured on the job, the construction safety officer will investigate the accident and handle any workers' compensation claims.
- The safety specialist shall teach proper safety and health procedures to the entire construction workers. Also, he should take initiatives to conduct training programmes and make safety drills which will help to update safety procedures as well as the importance of reporting a safety concern or injury.

Qualifications, roles and responsibilities of Environment Officer (EO) of CSC: The candidate shall be M.Sc. Environmental Science or graduate in Civil / Environmental Engineering. The candidate shall have professional experience of at least 5 years relevant to environmental management in infrastructure projects. Experience in implementation of EMP in externally aided/FIDIC based major highway projects is preferable. He should have adequate experience in implementing EMPs and organizing training to Contractor's and Employer's staff. He should be familiar with requisite procedures involved in obtaining and implementing environmental clearance requirements for project roads.

- The Environmental Officer (EO) will report to the Team leader of the Construction Supervision Team. The EO shall not instruct or direct the Contractor or Contractor's men

but can discuss various issues and environmental mitigation measures with all concerned directly or indirectly.

- All matters related to environmental and social activities within the ROW such as latest EIA, SIA, RAP and other related documents should be available to the EO immediately after mobilisation. The Forest, environmental clearance, Tamil Nadu Pollution Control Board's clearance conditions and other approval status should be specified. A status report prepared by PCC/ESMC of PMU would be required for the EO to start the work.
- The Environmental Officer (EO) should be mobilised during the early stages of construction. This is to help the Contractor in identifying environmentally sound locations for Construction camps, hot mix plant, WMM plant and all other issues according to the Environmental Management Action Plan (EMAP).
- The important role of EO during construction is to ensure the smooth implementation of EMAP and to address direct and indirect social issues arising out of implementation of the RAP.
- The EO should visit incomplete construction work sites where there are no contractor's current activities, active construction work sites and completed areas of the work sites and conduct regular meetings with the contractor in identifying gaps pertaining to both environment and construction safety. The EO will also visit the hot mix plant; quarries and crushers, borrow areas and others as per the necessity. EO has to ensure appropriate corrective and preventive action to the identified gaps in construction site in environmental aspects. Conduct regular meeting on environmental aspects with Environmental and Social Management Unit in HD.
- The EO will assist the Engineer to ensure environmentally sound engineering practices. In addition, other specialists of the engineers' team may also act and report on road safety related issues.
- The EO will carry out consultation with the Contractor, contractor's men, local Project Affected People (PAPs) and interest groups. The EO will also consult with NGOs to consider any problems (e.g. access problem to school, buildings, houses and business establishments) arising from construction activities.
- The EO will assist in the compliance with various labour laws including the payment of minimum wages to the individual contract labourer's especially 'unskilled illiterate migrant labourers'. This has a direct bearing on the health and safety of the workers.
- The EO will assist the Contractor, and the Highway Department in all matters related to public contacts including consultation, training and public relations.
- The EO will prepare standard formats (if available they may be obtained from other projects that are being implemented or are completed recently) for the compliance of the environmental and social requirements.
- The EO will ensure the procurement of materials that are included in the Bill of Quantities relating to environmental and social mitigation costs.
- The EO will assist the HD and the Contractor in all training activities during construction supervision period.
- The EO will prepare and submit regular reports to the team leader of CSC.
- The EO will assist the various Environmental monitoring activities of the Contractor / HD.
- The EO will be responsible to confirm whether the contractor has received all certifications in different sectors from the concerned authority to precede the work.
- The EO in co-operation with the EO of PMU and Superintending Engineer will make sure the issuing of timely Work order for the Nurseries to be raised according to the

‘Landscaping, Tree planting and Environmental Enhancement Plan’. This will allow one year for the plants to attain the required size.

4.3. ORGANISATION, STAFFING AND RESPONSIBILITIES OF CONSTRUCTION CONTRACTOR

The construction Contractor shall be responsible for undertaking all duties and works assigned in the road construction contract, including all specified conditions in the EMAP. The construction Contractor should prepare an implementation plan of mitigating actions specified in the EMP Activity Table. The Contractor will work closely with the Supervising Consultant to ensure that works are constructed to standard. Throughout this EMP, the construction Contractor is referred to as the ‘Contractor’ and the supervising Consultant is referred to as the ‘Construction Supervising Consultant’ (CSC). Detailed staffing pattern in the contractor’s office is given below in Table 4.1.

TABLE 4.1 STAFFING PATTERN IN CONTRACTOR’S OFFICE

S.No.	Designation	Nos.
1	Contract Manager	1
2	Construction Planning Engineer	1
3	Site Engineer	4
4	Quality Control/Material Engineer	1
5	Bridge Engineer	1
6	Earth Works Supervisor	6
7	Pavement Supervisor	2
8	Environmental Engineer	1

Roles and responsibilities of team leader of Contractor: The Team Leader of the Contractor shall be responsible for the timely implementation of EMP, as per the conditions stipulated in the Environmental Management Action Plan. S/he shall prepare an implementation plan of mitigating actions specified in the EMP Activity Table. H/she shall guide / supervise the ESE in ensuring that all construction work is undertaken in line with the requirements of EMP. The team leader shall ensure that the reporting procedures mentioned in EMAP and detailed out in Chapter 5 of this report is adhered to and required reports and management plans are submitted to CSC on time. The corrective actions, as suggested by CSC shall also be implemented and reported. S/he shall have good understanding of the contractual clauses, especially the penalty clause given in the bid document as well as Chapter-3 of this report. He also has to ensure that the responsibilities stipulated in EMAP for Defect Liability period are carried out.

Qualifications, roles and responsibilities of Environment and Safety Officer (ESO) of Contractor: The candidate shall be M.Sc. in Environmental Science or B.Tech. in Civil/ Environmental Engineering with two years field experience in environmental management of transportation projects.

The duties and responsibilities of the Environment and Safety Engineer in the contractor’s team are as follows:

- To ensure that all the contractor activities are done in line with the EMP requirements.

- To have good understanding of the contractual clauses, especially the penalty clause given in the bid document as well as Chapter-3 of this report.
- To verify the appropriateness of all the EMP items.
- To prepare a management and redevelopment plan for all the sites of identified project related ancillary facilities like (i) Construction camp, (ii) labour camp, (iii) quarry and stone crusher unit, (iv) borrow area and (v) debris disposal site in line with detailed guidelines given in EMP.
- To ensure that all the five sites and camps mentioned activity is operated, managed and closed in line with management and redevelopment plan.
- To ensure that the top soil preservation is done wherever required as per the guidelines.
- To ensure the adoption of proper waste management practices in the plant sites, labour camps, construction camps and along the road (also pertains to the proper disposal of bituminous / concrete waste generated during construction).
- To ensure that the Contractor does not violate any social norms such as employment of child labour, children at work sites, providing crèches, unhygienic working conditions and minimum wage considerations as per prevailing laws.
- To ensure that all the MORTH specifications are available and followed in all the contractor activities.
- To liaison with the Supervision Consultant and the PMU / HD on matters pertaining to the EMP.
- To liaison with Government Agencies such as the Pollution Control Boards and Forest Department in order to obtain the required clearances, and to ensure that the Contractor activities are carried out in line with any conditions placed.
- To ensure adoption of good construction-related safety practices and appropriate traffic management practices to ensure road safety during the construction phase.
- To prepare and implement a plan for road safety, accidents and traffic management.
- To demark the starting chainage & end chainage of the project as the construction zone, and provide sign boards as per accepted standards.
- To inform and train all the contractor personnel on the IRC requirements on construction safety and on road safety.
- To prepare and ensure implementation of an emergency response plan
- To ensure the availability of first aid facilities.

Reporting requirements of Contractor: The Contractor shall undertake regular reporting to CSC, comprising submission of reports as well as management and redevelopment plans to CSC as detailed in the Chapter -5 of this EMP.

4.4. INFORMATION DISSEMINATION

Information dissemination shall be undertaken by PMU at a macro level and by the Contractor in the project site at micro level. The wider dissemination of information to public shall be undertaken by PMU through the disclosure of EIA / EMP reports in the website of PMU. At the project site, i.e. the direct impact zone, information boards shall be displayed at critical and pre-identified locations to disseminate the project details. Such information boards shall display project name, contractor's name, concerned official's name in Contractor's office with his designation and contact no., name and contact details of an authorised official in local HD divisional office. These information boards shall be approximately of size 5' x 5' and shall be designed and put up in such a way that public can easily read it from a distance. Such boards

shall be set up, not only along active project stretches, but also at the sites of construction camps and labour camps and other project facilities like borrow area, quarry and stone crusher site and debris disposal site. These information boards shall also mention the availability of a complaint register with ESE of the Contractor. Under the RTI Act, 2005, Contractor is also duty bound to share any information demanded by the public, pertaining to any aspect of the project, as and when it is demanded.

4.5. GRIEVANCE REDRESSAL MECHANISM

Superintending Engineer of TNRSP will Grievance Reddressal Mechanism (GRM) Officer supported by Environment specialist and other team members. All grievances registered will be complied within 15 days and will be displayed. There will be facilities to lodge the complaints by email, phone call and letter. The email address, phone number and correspondence address will be available on TNRSP website.

4.6. TRAINING PROGRAMME ON ENVIRONMENTAL ASPECTS

Training is an investment made on the human resource of the organization to provide and tone the competencies, required to do an existing job well and also to perform for future needs. Targeted and monitored training can set up an environment of good morale and productivity and contributes in creating a powerhouse of competencies for the organisation. This section deals with the training to be imparted to the Contractor's staff by the EO and SCSS of CSC for ensuring effective implementation of EMP. The training requirement could be broadly identified as given in Table 4.2 below.

TABLE 4.2 TRAINING PROGRAMME TO THE CONTRACTOR'S STAFF

Programme	Particulars	Duration	Participants
Awareness programme for Labourers	General Awareness on Environment and Safety	One day	Skilled and unskilled labour
Awareness programme for Engineers and Supervisors	General Awareness on Environment and Safety	One day	Engineers, supervisors and office staff
Orientation Programme	Contractor's Responsibilities as per bid document and EMP	One day	Engineers including ESE
	Reporting System as per EMP	One day	

The need for additional and specialised training shall be examined and appropriate training will be undertaken as required.

CHAPTER - 5: ENVIRONMENTAL MONITORING AND REPORTING REQUIREMENTS

5.1. Monitoring and Reporting of Environmental Management Measures

A robust monitoring and reporting system is mandatory to ensure compliance to EMAP by the contractor. The monitoring and reporting system evolved for TNRSP is integrated into EMAP table and its annexure. It comprises following three parts:

- (A) Monitoring and reporting of environmental management measures for project related facilities like construction camp, labour camp, quarry area, borrow area and debris disposal site,
- (B) Monitoring and reporting of environmental management measures for overall project, and
- (C) Monitoring and reporting of quality of environmental parameters like air, water and noise.

This monitoring and reporting system attempts to pre-empt much of the environmental issues created during construction and post construction stages and provides the necessary feedback for CSC / PMU to make sure that EMAP is implemented in full spirit. Instead of a linear reporting system, this system works on a two way basis – initial reporting by contractor followed by monitoring by CSC based on contractor's reports. Responsibilities for monitoring will rest with the Environmental Officer of the Supervising Consultant reporting to the PMU and EMU at TNRSP.

The detailed procedure of reporting and monitoring system is as follows:

(A) Monitoring and Reporting of Environmental Management Measures for Project Related Facilities

Sage I – Site Identification: While initiating the project, the Contractor needs to identify suitable sites for project related ancillary facilities like construction camp, labour camp, quarry and stone crusher units, borrow area and debris disposal sites. The same shall be undertaken adhering to the criteria given in the respective guidelines for each of these sites given in Annexure 3.1 to 3.5. Once the site is identified by the Contractor, s/he shall prepare a site identification report furnishing all the details pertaining to the identified site using the reporting format given in Annexure 3.17 to 3.21 and submit it to the CSC. Subsequently, the EO of CSC has to visit each site and approve / reject the site with reasons. The EO of CSC has to give a copy of this format to the contractor after his approval / rejection with remarks. This reporting procedure needs to be undertaken for each and every parcel of land identified for any of the project related ancillary facility.

Stage II – Setting up of Sites: On approval of a site, the Contractor has to prepare the Management and Redevelopment Plan for this site as per the relevant Guidelines given in Annexure 3.1 to 3.5 of EMP and submit to CSC for approval. In addition to the Management and Redevelopment Plans for sites, the Contractor has to prepare Comprehensive Waste Management Plan, Occupational Health and Safety Management Plan, Traffic Management Plan and Hazardous Substances Management Plan for all sites together, as per the Guidelines given in EMP Annexure 3.6, 3.9, 3.10 and 3.11 respectively. Subsequently, the EO of CSC needs to visit

each site and approve the Management Plan. The EO of CSC has to give a copy of this management plan to the contractor after his approval with remarks / suggestions for additional mitigation measures. Any kind of activity could be initiated in a site only after getting approval from CSC for the Management and Redevelopment Plan for that site. These plans need to be prepared for each and every parcel of land identified as described above.

Stage III –Operation of Sites: Once the Contractor receives approval for the Management and Redevelopment Plan, s/he can initiate activities on the site. All the activities shall be undertaken strictly in line with the said plan. CSC shall monitor the implementation of management plan monthly once through site visits and the Checklists for Monitoring the Environmental Management of Sites / Camps given in Annexure 3.25 to 3.34. Corrective actions with specific timeframe should be proposed for each environmental management measure, which is not implemented satisfactorily. A copy of the filled up checklist should be given to the ESE of the Contractor. CSC has to attach this format to the Monthly Report to be submitted to PMU, with details of corrective action taken by the Contractor.

A Register of Sites Opened and Closed in the format given in Annexure 3.24 should be maintained by the contractor (preferably in A3 size paper) for each road. Details of each site opened should be entered in this register in chronological order. Whenever a site is closed, it should be recorded in this register with status of redevelopment. Clearances applicable for each site and the status of clearances should also be entered in this register. This same format shall be used to report the details of sites opened and closed to the CSC along with the Monthly Report of the Contractor. EO of CSC has to visit the sites, verify the details and approve the report with instruction to the contractor if any clearance is pending for any site or redevelopment is not done satisfactorily for any closed site. A copy of the approved report with CSC's remarks should be given to the ESE of the Contractor. The EO of CSC has to attach this format to the Monthly Report to be submitted to PMU, with details of corrective action taken by the Contractor.

Stage IV – Closure of Sites: Upon completion of the operation in any particular project ancillary facility site, the Contractor shall undertake redevelopment of the same, in line with the redevelopment plan which was already approved by CSC and intimate to CSC through the format for Register of Sites Opened and Closed. The Environmental Officer of the CSC shall monitor the same through site visit and the Checklists for Monitoring the Redevelopment of Sites / Camps provided in Annexure 3.25 to 3.34 as and when a site is closed and reported by the Contractor. Corrective actions with specific timeframe should be proposed for each environmental management measure, which is not implemented satisfactorily. A copy of the filled up checklist should be given to the ESE of the Contractor. CSC has to attach this format to the Monthly Report to be submitted to PMU, with details of corrective action taken by the Contractor.

As described above, the reporting tasks for project facilities have been split and shared among contractor and CSC and its summary is given below:

- One time reporting by contractor to CSC at the stage of identification of sites and camps
- One time reporting by contractor to CSC through management and redevelopment plans before setting up of sites and camps.
- Monthly reporting of sites opened and closed by contractor to CSC
- Monthly monitoring by CSC during the operation stage of sites and camps

- One time monitoring by CSC after the closure of each site and camp

(B) Monitoring and Reporting of Environmental Management Measures for Overall Project

The Contractor shall undertake regular monthly reporting to CSC using the format given in Annexure 3.46, and all other reporting formats shall be attached to this monthly report as annexure. The Monthly Report captures the physical progress of the work, main issues / concerns, corrective actions taken, no. of workers in the reporting month etc. Further, CSC shall report monthly to PMU, summarising the issues / concerns and actions taken. This report has to be prepared in the format given in Annexure 3.47 and all other reports are to be attached to it as annexure. All the reporting formats given in Annexure 3.17 to 3.24 and Annexure 3.35 to 3.45 shall be used by the Contractor to report environmental management measures related to various aspects of the overall project. These reports are to be submitted monthly by the Contractor to the CSC. The EO of CSC shall visit the sites and verify the implementation of management measures and approve the reports. EO of CSC should give a copy of the approved reports to the ESE of the Contractor with his remarks.

(C) Monitoring and Reporting of Environmental Quality

Environmental quality monitoring shall be undertaken by the Contractor through an NABL approved Laboratory, based on the Environmental Quality Monitoring Plan. The monitoring results shall be reported by the Contractor to the CSC in the Reporting Format for Environmental Quality Monitoring given in Annexure 3.41 along with the Monthly Report, if monitoring was due in that month. A copy of the monitoring report given by the Laboratory has to be attached to this format. The CSC has to visit the sites and verify the details.

Additional mitigation measures, if required, can be suggested by the CSC. The EO of CSC has to give back a copy of this format to the contractor after his approval with remarks.

5.2. Environmental Quality Monitoring Plan for the Project

For each of the environmental components, the monitoring plan specifies the technical aspects of monitoring like locations of monitoring, frequency of monitoring and duration, sampling method, parameters to be monitored and standards to be compared. The monitoring plan also specifies the applicable standards and implementation and supervising responsibilities. The guidelines for the monitoring program are given in Annexure 8.1. The **Annexure 8.1** is given with environmental standards for air, noise and water to be monitored during construction and operation of the project at Table 1.2A, 1.2B and 1.2C respectively.

CHAPTER - 6: ENVIRONMENTAL BUDGET

6.1. Mitigation/Enhancement Measures

Mitigation measures proposed in the EMAP will be implemented by the Contractor. The works to be undertaken by the Contractor have been quantified and the quantities included in the respective BOQ items such as earth works, slope protection, noise barriers, road safety features, and shrub plantation.

Provisional quantities have also been included for additional measures that may be identified during construction and for silt fencing which will depend on the Contractors work methods and site locations. Items and quantities have also been included for enhancement measures. The general environmental management measures to be followed by the contractor have been included in the specifications and this EMAP. These cannot be quantified and are to be included in the contract rates.

A summary of the Mitigation/Enhancement Measures which have been proposed in Annexures 3.51, 3.52 and 3.56 of this report is presented in Table 6.1.

TABLE 6.1: SUMMARY OF MITIGATION/ENHANCEMENT MEASURES

S. No	Asset	Direct Impact	Typical Measures	Indirect Impact	Typical Measures
1	Temple/Church/Mosque	57	Boundary Wall, Bench, Plantation, Realignment	114	Nil
2	Pond	4	Retaining wall, Desilting, Tree, Plantation, Realignment	22	Nil
3	Well	45	Nil (Compensation)	140	Nil
4	River	2	Nil	0	Nil
5	Hospital	1	Boundary Wall, Plantation	4	Boundary Wall, Plantation
6	Educational Institutions	9	Boundary Wall, Plantation	35	Boundary Wall, Plantation
7	Bus Stop	44	Nil	15	Nil
8	Overhead Tank	3	Nil	44	Nil
9	Grave yard/Crematoria	6	Realignment	17	Nil
10	Railway line	0	Nil	1	Nil
11	Anganwadi/Woman training centre	0	Nil	3	Nil
Total		171		395	

6.2. Cost Estimates

The cost estimates are done for the surface water bodies, ground water bodies, sensitive receptors, trees and religious/cultural and community structures which are described briefly as follows. The cost estimate for the implementation of the environmental management plan of the project is presented in Table 6.2.

6.2.1. Surface Water Bodies

Surface water bodies are community-based and therefore enhancement measures are proposed. Mitigation/enhancement measures of surface water bodies which are directly affected are given.

6.2.2. Ground Water Bodies:

Ground Water Bodies are privately-owned irrigation wells. Loss of such sources will be compensated in financial terms and no enhancement measures are proposed. Assets which experience no direct impact will not be provided any compensation.

6.2.3. Sensitive Receptors:

All sensitive receptors i.e. schools, hospitals and religious/cultural features, whether or not subject to direct impact, the following measures are proposed.

- To construct boundary wall and plant trees where boundary wall is demolished.
- To repair wall where needed and plant trees
- Where feature is not directly impacted, plant trees and build wall along road to act as noise barrier, hence no separate noise barrier is provided.

6.2.4. Trees

Forest

- Provision for expenditure on diversion of forest land has been made under the following heads;
- Cost of forest land diverted to widening of road
- Afforestation on non forest land transferred to forest department by revenue department in lieu of forest land diverted

Compensatory Afforestation

- **Avenue Plantation:** Trees shall also be planted along the project corridors. Their number is included in compensatory afforestation. Costing has been done as per forest schedule of rate, including the plantation and maintenance cost for 3 years.
- **Plantation at Enhancement sites:** A number of tourist places are located along the project corridor. To enhance the aesthetic beauty of these locations, indigenous species of trees are proposed and their cost has been estimated. Their number is in addition to compensatory afforestation
- **Landscaping at Junctions and medians etc:** Cost if any will be included as part of engineering measures since geometric design has a direct bearing such plantation.

6.2.5. Religious/cultural and other Community assets

Cost of mitigation/enhancement measures at religious/cultural and other community assets within the Corridor has been included.

6.2.6. Bus Stops

Bus stops with shelters are proposed in lieu of those which will be removed due to the Project and in additional locations in order to improve safety and increase road capacity.

At locations where existing RoW is more than proposed RoW, recessed bus bays will be provided. Cost an account of bus shelters/bus bays forms part of engineering cost estimates and is therefore not included in environmental management cost.

TABLE 6.2: COST ESTIMATES FOR ENVIRONMENTAL MANAGEMENT

S NO	Item	Unit	Rate	Qty	Cost	Remarks
A	PRE-CONSTRUCTION PHASE					
1	Tree felling permission	No.		7187		
2a	Forest clearance	<i>Covered under regulatory clearances</i>				
2b	Forest land diversion cost	<i>To be done under transfer arrangement from Revenue Dept.</i>				
2c	cost of forest land diverted to non forest purpose	Ha	0	0	0	
2d	Afforestation on balance non forest land transferred to forest department by revenue department in lieu of forest land transferred by forest department	NA				
3	Tree cutting	No.		7187		
4	Utility shifting	<i>Covered under Engineering cost</i>				
	Total Cost					
B	CONSTRUCTION PHASE					
1	Mitigation Measures					
1.1	Oil Interceptor	No		3		
1.2	Silt Fencing	m		4230		
1.3	Recharge pit for urban drains			0		
1.4	Soak pit for Handpumps/wells			0		
1.5	Relocation of ground water source	Nos		34		CMRL Rate for open wells 2014, directly impacted irrigation well
1.6	Relocation of handpumps	Nos		82		CMRL Rate 2014, directly impacted hand pumps

1.7	Desilting/deepening of ponds	Nos		Included in Item-6		Item 49,76 TNPWD, Rs.30.75 for 10m lead+Rs.5.25/ev every additional lead of 10m=Rs.41.25/cum. Escalated at 5%=Rs.43.31/cum. Used LS rate Rs 1.5 lakh per pond
1.8	Retaining wall for ponds	Rm		1330		
2	Tree Plantation & protection					
2.1	Avenue plantation & compensatory plantation					
2.1.1a	Compensatory plantation & maintenance of sampling for 3 years			71870		
2.1.1b	Avenue plantation & maintenance for 3 years			18180	included in item 2.1.1a	at 1tree/10m
2.1.2	Tree Guards					
	Brush wood fence			18180	included in item 2.1.1a	
2.2	Plantation in realignment location	<i>included in item 2.1</i>				
3	Landscaping			0	0	
4	Monitoring of environmental attributes					
4.1	Air quality					

4.1.1	Hot mix plant (One location)			9		Awarded rates 2014, Air and Noise, Monitoring : Hot Mix Plant, one location per road, Frequency : 24 hourly monitoring once in a season for three season in a year for three years Water and Soil Monitoring Frequency : once in a season for three seasons in a year for three years	
4.1.2	Critical location (9 Locations)			81			
4.2	Noise levels						
4.2.1	Equipment yards (One Location)			18			
4.2.2	Critical locations (9 Location)			162			
4.3	Water quality (5 Locations)						
4.3.1	Monitoring of water quality			45			
4.4	Soil quality (5 Locations)						
4.4.1	Monitoring of soil quality			45			
4.4.2	Additional soil monitoring			0			
5	Orientation of IA staff	<i>Deemed to be included in consultancy fee</i>					
6	Mitigation/enhancement measures						
6.1	Religious/cultural assets						
	Temple, Km 29.300, LHS			1		Annexure 3.55	
	Temple, Km 29.700, RHS			1		Annexure 3.55	
	Temple, Km 29.800, LHS			1		Annexure 3.55	
	Temple, Km 29.900, RHS			1		Annexure 3.55	
	Temple, Km 29.900, RHS			1		Annexure 3.55	
	Temple, Km 30.000, RHS			1		Annexure 3.55	
	Temple, Km 30.100,RHS			1		Annexure 3.55	
	Temple, Km 30.100,RHS			1		Annexure 3.55	
	Temple, Km 30.600,LHS			1		Annexure 3.55	
	Temple, Km 31.500, RHS			1		Annexure 3.55	

	Temple, Km 32.900,RHS			1		Annexure 3.55
	Temple, Km 36.750, RHS			1		Annexure 3.55
	Temple, Km 37.650,RHS			1		Annexure 3.55
	Temple, Km 37.875,RHS			1		Annexure 3.55
	Temple, Km 41.450,RHS			1		Annexure 3.55
	Temple, Km 42.575,RHS			1		Annexure 3.55
	Temple, Km 43.525, LHS			1		Annexure 3.55
	Temple, Km 44.100,RHS			1		Annexure 3.55
	Temple, Km 45.700,RHS			1		Annexure 3.55
	Temple, Km 46.375,LHS			1		Annexure 3.55
	Temple, Km 48.650,RHS			1		Annexure 3.55
	Temple, Km 52. 450,RHS			1		Annexure 3.55
	Temple, Km 62.600,RHS			1		Annexure 3.55
	Temple, Km 65.600,RHS			1		Annexure 3.55
	Temple, Km 65.880,RHS			1		Annexure 3.55
	Temple, Km 66.990,RHS			1		Annexure 3.55
	Temple, Km 67.350,RHS			1		Annexure 3.55
	Temple, Km 67.862,RHS			1		Annexure 3.55
	Temple, Km 71.050,RHS			1		Annexure 3.55
	Temple, Km 71.700,LHS			1		Annexure 3.55
	Temple, Km 77.725,LHS			1		Annexure 3.55
	Temple, Km 78.050,RHS			1		Annexure 3.55
	Temple, Km 81.500,RHS			1		Annexure 3.55
	Temple, Km 82.600,RHS			1		Annexure 3.55
	Temple, Km 84.615,RHS			1		Annexure 3.55
	Temple, Km 85.425,RHS			1		Annexure 3.55
	Temple, Km 85.650,RHS			1		Annexure 3.55
	Temple, Km 88.425,LHS			1		Annexure 3.55
	Temple, Km 89.200,LHS			1		Annexure 3.55
	Temple, Km 97.028,RHS			1		Annexure 3.55
	Temple, Km 99.235,LHS			1		Annexure 3.55
	Temple, Km 99.750,RHS			1		Annexure 3.55
	Temple, Km 101.075,LHS			1		Annexure 3.55
	Temple, Km 101.075,RHS			1		Annexure 3.55
	Temple, Km 101.950, RHS			1		Annexure 3.55
	Temple, Km 102.300,RHS			1		Annexure 3.55
	Temple, Km 103.275,RHS			1		Annexure 3.55
	Temple, Km 107.330,RHS			1		Annexure 3.55
	Temple, Km 107.775,LHS			1		Annexure 3.55
	Temple, Km 113.250,RHS			1		Annexure 3.55
	Temple, Km 113.250,RHS			1		Annexure 3.55
	Temple, Km 113.850,RHS			1		Annexure 3.55
6.2	Noise sensitive receptors					
	Hospital, Km 29.800,RHS			1		Annexure 3.55

	Hospital, Km 37.600,LHS			1		Annexure 3.55
	Hospital, Km 64.300,RHS			1		Annexure 3.55
	Hospital, Km 79.700,LHS			1		Annexure 3.55
	Hospital, Km 102.900,RHS			1		Annexure 3.55
	School, Km 24.625, LHS			1		Annexure 3.55
	School, Km 29.500,RHS			1		Annexure 3.55
	School, Km 29.900,LHS			1		Annexure 3.55
	School, Km 30.600, LHS			1		Annexure 3.55
	School, Km 30.600, LHS			1		Annexure 3.55
	School, Km 31.650,LHS			1		Annexure 3.55
	School, Km 32.550, RHS			1		Annexure 3.55
	School, Km 34.500, LHS			1		Annexure 3.55
	School, Km 35.400,LHS			1		Annexure 3.55
	School, Km 37.575,RHS			1		Annexure 3.55
	School, Km 43.400,RHS			1		Annexure 3.55
	School, Km 43.850, RHS			1		Annexure 3.55
	School, Km 43.900,LHS			1		Annexure 3.55
	School, Km 53.150,RHS			1		Annexure 3.55
	School, Km 53.725, LHS			1		Annexure 3.55
	School, Km 56.650, LHS			1		Annexure 3.55
	School, Km 63.750, RHS			1		Annexure 3.55
	School, Km 63.950,LHS			1		Annexure 3.55
	School, Km 72.400 RHS			1		Annexure 3.55
	School, Km 74.425,RHS			1		Annexure 3.55
	School, Km 80.900,LHS			1		Annexure 3.55
	School, Km 86.510, RHS			1		Annexure 3.55
	School, Km 86.834,LHS			1		Annexure 3.55
	School, Km 90.750,RHS			1		Annexure 3.55
	School, Km 95.800,LHS			1		Annexure 3.55
	School, Km 95.800,RHS			1		Annexure 3.55
	School,KM 95.800,LHS			1		Annexure 3.55
	School,KM 99.850,LHS			1		Annexure 3.55
	School,Km 101.0754,RHS			1		Annexure 3.55
	School,Km 101.490, LHS			1		Annexure 3.55
	School,Km 106.300,LHS			1		Annexure 3.55
	School,Km 106.350,LHS			1		Annexure 3.55
	School,Km 107.150,LHS			1		Annexure 3.55
	School,Km 107.900,RHS			1		Annexure 3.55
	School, Km 108.600,RHS			1		Annexure 3.55
	School,Km 109.200,LHS			1		Annexure 3.55
	School,Km 109.850,LHS			1		Annexure 3.55
	School,Km 112.250,RHS			1		Annexure 3.55
	School,Km 114.250, LHS			1		Annexure 3.55
6.3	Surface Water Bodies					

	Pond, Km 40.550,LHS			1		Annexure 3.55
	Pond, Km 43.400,LHS			1		Annexure 3.55
	Pond, Km 85.800,LHS			1		Annexure 3.55
	Pond, Km 96.300,RHS			1		Annexure 3.55
	Pond, Km 45.700,LHS			1		Annexure 3.55
	Pond, Km 57.816,LHS			1		Annexure 3.55
	Pond, Km 59.050, RHS			1		Annexure 3.55
	Pond, Km 64.469,RHS			1		Annexure 3.55
	Pond, Km 65.200,LHS			1		Annexure 3.55
6.4	Other community utilities					
	graveyrd/crematoria					
	Grave yard km 66.200,LHS			1		
	Grave yard km 66.300,LHS			1		
	Grave yard km 68.350,LHS			1		
6.5	Incidental spaces	Nil				
	Total cost of environmental measure during construction phase					
C	GOOD ENGINEERING PRACTICES	<i>Covered under Engineering Costs</i>				
1	Dust suppression					
2	Erosion control measures (turfing/pitching/seeding and mulching)					
3	Provision of cross drainage and side drainage structures					
4	General borrow area management and maintainance of haul road related to borrow areas					
5	Air/ Noise pollution control measures in construction equipment					
6	Management and disposal of scarified waste bituminous material					
7	Provision of inforatory signs					
8	Bus shelters					
9	Construction of Speed Humps					
10	Cattle Crossings					
11	Management of quarries	<i>Deemed to be included in contractor's quoted rates</i>				
12	Redevelopment of Borrow Areas					
13	Construction Camp Mangement Costs	<i>Will form a part of the Contractor's cos</i>				
14	Safety measures for workers					

D	ITEMS COVERED UNDER THE RAP BUDGET					
1	Relocation of private Properties	Covered under RAP Budget				
2	Relocation of private Water points (wells, tanks, water taps and hand pumps)					
3	Relocation of graveyards, statues, motor sheds					
4	Relocation of Other Community Assets (private)					
E	OPERATION PHASE					
1	Monitoring of Environmental Attributes during Operation Phase					
1.1	Monitoring of Air Quality at 9 Critical Locations	Per Sample		54		Three season in a year for 2 years
1.2	Monitoring of Noise Levels at 9 Critical Locations	Per Sample		54		Three season in a year for 2 years
1.3	Monitoring of Water Quality at 5 Locations	Per Sample		60		Three seasons in a year for 2 years
1.4	Monitoring of Soil Quality at 5 Locations	Per Sample		60		Three season in a year for 2 years
1.5	Additional Soil Monitoring during Spills	Per Sample		0		Throughout operation phase say 20 yrs
1.6	Noise mitigation measures in form of noise barrier at sensitive receptors	Included in item 6				
2	Information Dissemination	Covered under RAP				
3	Additional Training for Land use Management at Package Level	Package		3		
Environmental Budget During Operation Phase						
Sub Total (A+B+E)				INR		
GRAND TOTAL US\$ @ INR 60.00/\$				US\$		
* The number of trees required for compensatory afforestation will be planted as avenue plantation.						

ANNEXURE 3.1: GUIDELINE FOR SITING, MANAGEMENT & REDEVELOPEMENT OF CONSTRUCTION CAMP

(A) SITING

The contractor based on the following guidelines shall identify the location of the construction site. The construction site shall be located:

- The construction camps will be located at least 1000m away from major settlements in downwind direction. The living accommodation and ancillary facilities for labour shall be erected and maintained to standards and scales approved by the resident engineer.
- A minimum 500m away from surface water course or body.
- A minimum 1000m away from Wild life Sanctuary/Ecologically sensitive areas.
- Should not be located in cultivable land unless unavoidable.
- All sites used for camps must be adequately drained.
- The camps must be located such that the drainage from and through the camps will not endanger any domestic or public water supply.
- All sites must be graded, ditched and rendered free from depressions such that water may get stagnant and become a nuisance.

(B) LAYOUT

A conceptual layout of a typical construction site has been presented in Figure below. The Contractor during the progress of work will provide, erect and maintain necessary (temporary) living accommodation and ancillary facilities for labour to standards and scales approved by the engineer. All temporary accommodation must be constructed and maintained in such a fashion that uncontaminated water is available for drinking, cooking and washing. Safe drinking water should be provided to the dwellers of the construction camps. Adequate washing and bathing places shall be provided, and kept in clean and drained condition. Construction camps are to be sited away from vulnerable people and adequate health care is to be provided for the work force.

Sanitation Facilities: Construction camps shall be provided sanitary latrines and urinals. Sewerage drains should be provided for the flow of used water outside the camp. Drains and ditches should be treated with bleaching powder on a regular basis. The sewage system for the camp must be properly designed, built and operated so that no health hazard occurs and no pollution to the air, ground or adjacent watercourses takes place. Compliance with the relevant legislation must be strictly adhered to. Garbage bins must be provided in the camp and regularly emptied and the garbage disposed off in a hygienic manner

Shelter at Workplace: At every workplace, there shall be provided free of cost, four suitable shelters, two for meals and two others for rest, separately for use of men and women labourers. The height of shelter shall not be less than 3m from floor level to lowest part of the roof. Sheds shall be kept clean and the space provided shall be on the basis of at least 0.5m² per head.

Canteen Facilities: A cooked food canteen on a moderate scale shall be provided for the benefit of workers wherever it is considered necessary. The contractor shall conform generally to sanitary requirements of local medical, health and municipal authorities and at all times adopt such precautions as may be necessary to prevent soil pollution of the site.

First aid facilities: At every workplace, a readily available first-aid unit including an adequate supply of sterilized dressing materials and appliances will be provided. Workplaces remote and far away from regular hospitals will have indoor health units with two bed facility. Suitable

transport will be provided to facilitate taking injured and ill persons to the nearest hospital. At construction camp an ambulance room containing the prescribed equipment and nursing staff will be provided.

Health Care Facilities: Health problems of the workers should be taken care of by providing basic health care facilities through health centres temporarily set up for the construction camp. The health centre should have at least a doctor, nurses, duty staff, medicines and minimum medical facilities to tackle first-aid requirements or minor accidental cases, linkage with nearest higher order hospital to refer patients of major illnesses or critical cases.

The health centre should have MCW (Mother and Child Welfare) units for treating mothers and children in the camp. Apart from this, the health centre should provide with regular vaccinations required for children.

Day Crèche Facilities: At every construction site, provision of a day crèche shall be worked out so as to enable women to leave behind their children. At construction sites where 20 or more women are ordinarily employed, there shall be provided at least a hut for use of children under the age of 6 years belonging to such women. Huts shall not be constructed to a standard lower than that of thatched roof, mud walls and floor with wooden planks spread over mud floor and covered with matting. Huts shall be provided with suitable and sufficient openings for light and ventilation. There shall be adequate provision of sweepers to keep the places clean. There shall be two maidservants (or aayas) in the satisfaction of local medical, health, municipal or cantonment authorities. Where the number of women workers is more than 25 but less than 50, the contractor shall provide with at least one hut and one maidservant to look after the children of women workers. Size of crèches shall vary according to the number of women workers employed.

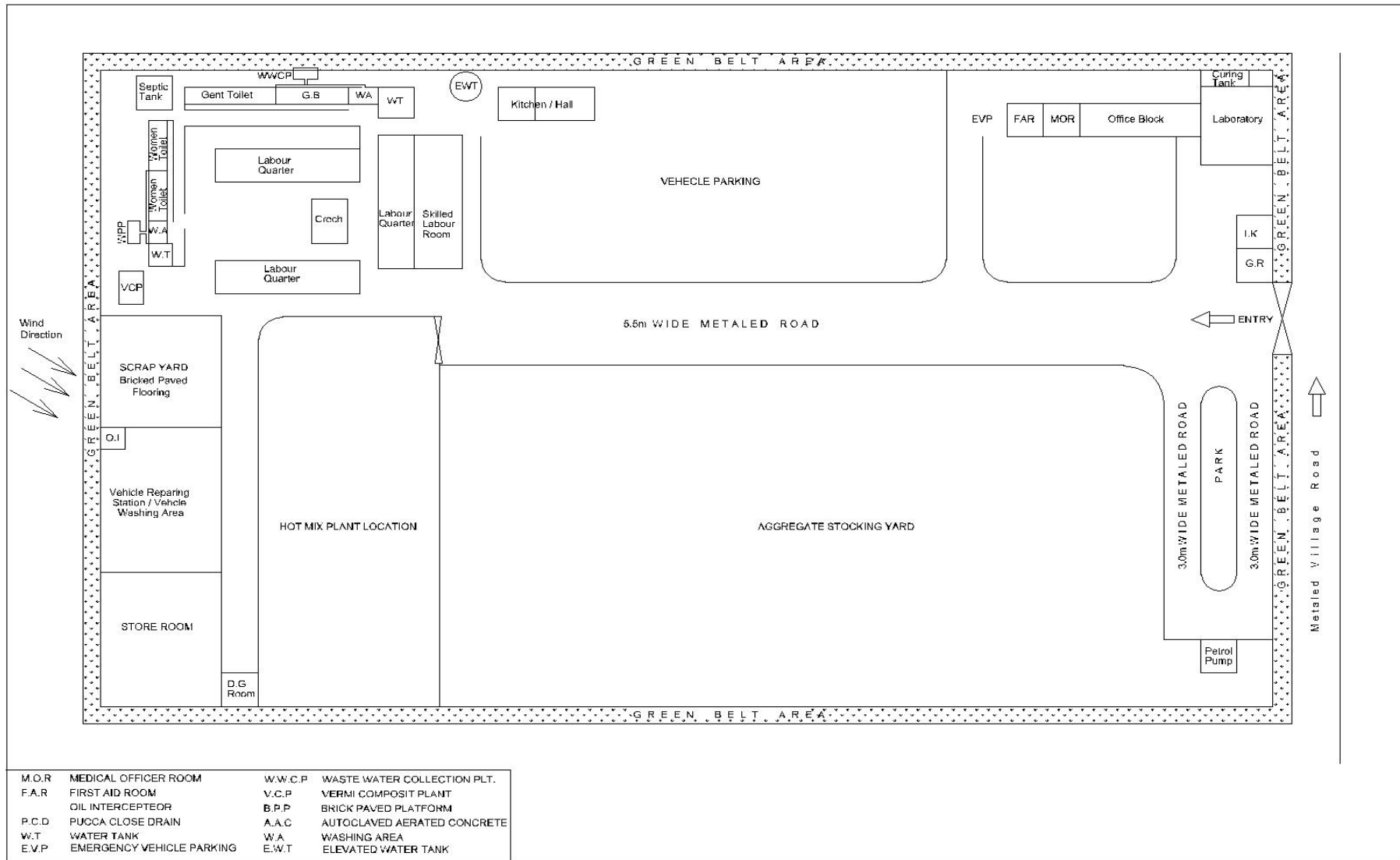

Typical Layout of Construction Camp

ANNEXURE 3.2 GUIDELINES FOR SITING, MANAGEMENT AND REDEVELOPMENT OF LABOUR CAMPS

A. OVERVIEW

Staff-quarters include accommodation for Engineers / Supervisors and labour camp include accommodation for workers / labourers along with other basic amenities such as kitchen, potable water supply, sanitation (toilets, bathrooms, washing areas and water supply for such needs), first aid room as well as garbage collection and disposal facility. Staff quarters shall be provided with additional facilities of drawing room. The guidelines outlined here aims to facilitate the Contractor in implementing the measures in the EMP there by reducing the impact on the environment.

A guidance note prepared by IFC and EBRD for the processes and standards of Workers Accommodation may be consulted for labour camp.

B. CRITERIA FOR LOCATING THE SITE/S

Following criteria should be followed in the siting of labour camps:

- ~ To the extent possible, agricultural lands and fertile lands shall be avoided².

C. FINALIZATION OF SELECTED SITE/S

After identification of the site, the Contractor should fill up the prescribed reporting format provided in EMAP and submit the same for approval to the CSC. The selected site/s shall be approved by Environmental Officer of CSC, after considering the compliance with the EMP clauses. No agreements or payments shall be made to the land owner/s prior to receipt of a written approval from the CSC. Any consequence of rejection prior to the approval shall be the responsibility of the Contractor and shall be made good at his own cost. After obtaining a written approval from the CSC for the selected site, the Contractor has to enter into an agreement with the landowner to obtain his/her consent before commencing any operation / activities in the land. The agreement should also mention its type, duration, amount and mode of payment as well as the preferences of the owner regarding site maintenance and redevelopment.

D. DESIGNING AND SETTING UP OF LABOUR CAMP

Following facilities should be provided in a labour camp to ensure safe, clean and hygienic accommodation for the workers.

(i) Site preparation: The site should be graded and rendered free from depressions such that the water does not get stagnant anywhere. Fencing should be constructed all around the camp to prevent the trespassing of humans and animals. Green belt should be provided along the boundary and as detailed in the EMP, it should be integrated with storm water drain and sedimentation trenches as given in annexure in EMAP. No. of trees planted should not be less than three times the number of trees cut. The approved layout plan should be strictly adhered to while setting up the camp.

(ii) Accommodation: Contractor will follow all relevant provisions of the Factories Act, 1948 and the Building and the other Construction Workers (Regulation of Employment and Conditions of Service) Act, 1996 for construction and maintenance of labour camp. The height of the worker's and labour accommodation shall not be less than 3mt. from floor level to the lowest part of the roof. The camps shall

be floored with concrete, shall be kept clean, and with proper cross ventilation, and the space provided shall be on the basis of one sq.mt per head or as per the relevant regulation, whichever is higher. Fire and electrical safety pre-cautions shall be adhered to. Cooking, sanitation and washing areas shall be provided separately. The Contractor will maintain necessary living accommodation and ancillary facilities (including provision of clean fuel to prevent damage to forests and to prevent fuel wood cutting and burning by labour) in functional and hygienic manner.

The site must be graded and rendered free from depressions such that water does not get stagnant anywhere. The entire boundary of the site should be fenced all around with barbed wire so as to prevent the trespassing of humans and animals. Green belt should be provided along the boundary and it should be integrated with storm water drain and sedimentation trenches to reduce the surface run off as per clauses in EMAP. No. of trees planted should not be less than three times the number of trees cut.

(iii) Drinking Water: The Contractor should provide potable water within the precincts of every workplace in a cool and shaded area, which is easily accessible as per standards set by the Building and other Construction Workers (Regulation of Employment and Conditions of Service) Act, 1996. All potable water storage facilities will be on a safely raised platform that is at least 1m above the surrounding ground level. Such facilities shall be regularly maintained from health and hygiene point of view. If necessary water purifier units shall be installed for providing potable water.

As far as possible shallow wells should not be used as potable source of water. However, if water is drawn from any existing well, irrespective of its location from any polluting sources, regular disinfection of the water source (which may include application of lime, bleaching power and potassium permanganate solution) has to be ensured at weekly/fort nightly interval. All open wells will be entirely covered and will be provided with a trap door to prevent accidental fall and contamination from dust, litter etc. The trap door will be kept locked and opened only for cleaning or inspection, which will be done at least once in a month. A reliable pump will be fitted to each covered well. A drain shall be constructed around the well to prevent flow of contaminated water into the well from road, camp or other sources. Water quality testing of all potable water sources will be done every six months as per parameters prescribed in IS 10500: 2012.

(iv) Sanitation Facilities: Adequate no. of toilets shall be provided separately for males and females (depending on their strength), screened from those of men and provided with markings in vernacular language. All such facilities must have adequate water supply with proper drainage and disposal facility. They shall be maintained, cleaned and disinfected daily using proper disinfectants. Location and design of soak pit should be in such a way that it doesn't pollute the ground water. Drains and ditches should be treated with bleaching powder on a regular basis. The sewage system for the camp must be properly designed, built and operated so that no health hazard occurs and no pollution to the air, ground or adjacent watercourses takes place.

Portable toilets may be brought to use and the night soil from such units has to be disposed through designated septic tanks so as to prevent pollution of the surrounding areas. In the main camp, no night soil or sewerage shall be disposed of at any place other than the septic tanks constructed at the site. All these facilities shall be inspected on a weekly basis to check the hygiene standards.

(v) Waste Disposal: The Contractor should provide garbage bins in the camps and ensure that these are regularly emptied and disposed off in a hygienic manner. No incineration or burning of wastes shall be carried out by the Contractor. Separate bins shall be provided for biodegradable, non-biodegradable and domestic hazardous wastes. The disposal of kitchen waste and other biodegradable matter shall be carried

out in pits covered with a layer of earth within the camp site. The Contractor may use the compost from such wastes as manure in the plantation sites. Discarded plastic bags, paper and paper products, bottles, packaging material, gunny bags, hessian, metal containers, strips and scraps of metal, PVC pipe scrubber and poly urethane foam, auto mobile spares, tubes, tires, belts, filters, waste oil, drums and other such materials shall be either reused or sold /given out for recycling.

(vi) Day Crèche Facility: At every construction site, provision of a day crèche shall be made so as to enable women to leave behind their children while going to work. At least one attendant shall be provided to take care of the children at the crèche. At construction sites where 20 or more women are employed, there shall be at least one shelter for use of children under the age of 6 years belonging to such women.

Shelters shall not be constructed to a standard lower than that of thatched roof, mud walls and floor with wooden planks spread over mud floor and covered with matting. Such areas shall be safely barricaded (no sharp sheets or barbed wires that may injure a child) from rest of the camp for the safety of children. Shelters shall be provided with suitable and sufficient openings for light and ventilation. There shall be adequate provision to keep the place clean. The size of a crèche may vary according to the number of children on a camp site.

(vii) Mess and Kitchen Facilities: The Contractor shall adhere to the sanitary/hygiene requirements of local medical, health and municipal authorities at all times. Adopt such precautions as may be necessary to prevent soil and water pollution at the site while operating mess or kitchen facilities.

(viii) First aid facilities: At every workplace, a readily available first-aid unit including an adequate supply of sterilized dressing materials and appliances should be provided. Workplaces remote and far away from regular hospitals should have indoor health units with one bed for every 250 workers. Suitable transport should be provided to facilitate taking injured and ill persons to the nearest hospital. Adequate personal protective equipments and fire fighting equipments as detailed out in EMP should be made available in the camp and provided to the staff / workers.

(ix) Health Care Facilities: Health problems of the workers should be taken care of by providing basic health care facilities. If there is no hospital or clinic, which can be accessed in half an hour's time, then a temporary health center should be set up for the construction camp. The health centre should have at least a doctor and a nurse, duty staff, medicines and minimum medical facilities to tackle first aid requirements or minor accidental cases, linkage with nearest higher order hospital to refer patients of major illnesses or critical cases.

The health centre should have MCW (Mother and Child Welfare) units for treating mothers and children in the camp. Apart from this, the health centre should be provided with regular vaccinations required for children. The health centre should carryout quarterly awareness programme of HIV – AIDS with the help of AIDS control society as well as about community living and hygiene practices in day to day living. Posters should be exhibited in the health care clinic.

There will be an awareness programmes about the spread of communicable diseases and precautionary measures to prevent these diseases.

E. OPERATION OF LABOUR CAMP

Throughout the functioning period of the camp, hygienic environment must be ensured by (i) provision of safe drinking water, (ii) proper maintenance of toilets including daily cleaning and disinfection using proper disinfectants, (iii) regular cleaning of drains by removing the silt and solid waste, (if any) and iv)

appropriate waste management practices. While it is of utmost importance to ensure that fire-fighting equipments like fire extinguishers are in working condition, it should also be monitored that construction workers use the personal protective equipments provided to them and they are replaced when necessary. All these facilities should be inspected on a weekly basis to achieve the desired levels of safety and hygiene standards.

F. PREPARATION OF LABOUR CAMP MANAGEMENT AND RE-DEVELOPMENT PLAN

After the site for the labour camp has been finalized and approved by CSC, the Contractor should prepare a labour camp management and redevelopment plan to be submitted to CSC for approval prior to setting up of the camp and it should comprise the following details:

- ~ **Section-1: Details of site:** Copy of approved site identification report along with location plan on a village map or an FMB, showing the site, its survey no., access road, project stretch, distance from the project stretch, surrounding features and land use like residences, agricultural land, water bodies etc., photograph of the site showing the topography and other existing features.
- ~ **Section-2: Site preparation:** Activities that should be undertaken for preparing the site based on EMP and this guideline.
- ~ **Section-3: Arrangements/ facilities within the camp:** List of facilities to be provided along with its details like area, no of people to be accommodated and a layout plan showing the plan of the site with all the facilities planned like quarters, labour camps, mess, common facilities, toilet facilities and the vehicular and pedestrian movement paths.
- ~ **Section-4: Mitigation measures** that should be undertaken as per the EMP and this guideline while setting up of the camp and operation of the camp should be separately listed out here.
- ~ **Section-5: Other details:** Any other relevant detail like list of awareness camps to be provided to workers, details of information dissemination etc. should be included.
- ~ **Section 6: Re-development plan:** which should indicate following points: (i) List of structures to be demolished and list of the cleanup activities that needs to be undertaken, (ii) Proposed use of the land in the post construction phase, if it is a public property, (iii) Presence of existing facilities that could be put in use by the land owner if it is a leased out private land or by the community in case of a public property.
- ~ **Section-7: Annexure-(a) Working drawings:** Electrical plan showing the electrical network planned for the site, location of generators, master switch boards etc. and plumbing drawing showing the network of water supply lines, water tank, drainage facilities etc. (b) Copy of permissions obtained from local governing body / community etc. as applicable, (c) Copy of agreement entered with site owner, in case of leased out sites.

All the drawings should have north direction marked in it along with prevailing wind direction. Necessary dimensions and specifications should be provided where ever necessary. The labour camp management plan should be submitted to the CSC for a written approval before any physical work is undertaken on a particular site. The CSC will carefully examine the proposals in light of the various EMP and regulatory provisions and provide suggestions, as necessary to the Contractor who shall incorporate it in the management plan. Contractor shall be responsible for satisfactory and timely completion of these

EMP requirements.

Contractor needs to prepare this document for each different site identified and CSC shall undertake a thorough analysis of the said management and redevelopment plan through a site investigation and suggest additional mitigation measures depending on the site and as demanded by the features of the specific site.

G. RE DEVELOPMENT OF THE LABOUR CAMP

The Contractor should clear all temporary structures; dispose all building debris, garbage, night soils and any other waste as per the approved debris management plan. All disposal pits or trenches should be filled in, disinfected and effectively sealed off. Residual topsoil, if any will be distributed or spread evenly in plantation sites, on adjoining/near-by barren land or affected agricultural land adjacent to the RoW that has been impacted on account of any accidental spillage. Entire camp area should be left clean and tidy, in a manner keeping the adjacent lands neat and clear, at the Contractor's expense, to the entire satisfaction of landowner and the CSC.

These activities should be completed by the Contractor prior to demobilization. Once the Contractor finishes his job, he needs to obtain a certificate from the owner, stating that the site has been redeveloped to his/her satisfaction and in tune with the agreement. Then following documents needs to be submitted to the CSC by the Contractor:

- ~ Copy of approved site identification report
 - ~ Photographs of the concerned site 'before' and 'after' setting up the camp.
- ~ Certificate from the owner stating his/her satisfaction about status of re-development of the site.

CSC shall ensure, through site verification that all clean-up and restoration operations are completed satisfactorily and a written approval should be given to the Contractor mentioning the same before the 'works completion' certificate is issued/recommended. The PMU shall ensure through site inspection that the Contractor and CSC have complied with all these provisions. The site can then be handed over to the concerned owner or local bodies or for local communities as the case may be.

Certification/documentation pertaining to approval for clean-up and restoration operations and thereafter handing-over to the owner shall be properly maintained by the Contractor, Supervision Consultant and PMU.

ANNEXURE3.3: GUIDELINES FOR SITING, MANAGEMENT AND REDEVELOPMENT OF QUARRYING AND STONE CRUSHING OPERATIONS

The Contractor will finalize the locations from the list given by DPR Consultant's for procuring materials. The Contractor shall establish a new quarry only with the prior consent of the EO only in cases when: (i) Lead from existing quarries is uneconomical and (ii) Alternative material sources are not available. The Contractor shall prepare a Redevelopment Plan for the quarry site and get it approved by the EO/Supervision Consultant.

The construction schedule and operations plans to be submitted to the EO prior to commencement of work shall contain a detailed work plan for procuring materials that includes procurement, transportation and storage of quarry materials.

Operation & redevelopment plan (if a new quarry is opened).....

- Photograph of the quarry site prior to commencement
- The quarry boundaries as well as location of the materials deposits, working equipments, stockpiling, access roads and final shape of the pit.
- Drainage and erosion control measures at site.
- Safety Measures during quarry operation.
- Design for redevelopment of exhaust site.

Option-A: Revegetating the quarry to merge with surrounding landscape: This is done by conserving and reapplying the topsoil for the vegetative growth.

Option-B: Developing exhausted quarries as water bodies: The pit shall be reshaped and developed into pond, for harvesting rainwater. This option shall only be considered where the location of quarry is at the lowest point, i.e. surrounding areas/natural drainage slopes towards it.

CONSTRUCTION STAGE

Development of site: To minimize the adverse impact during excavation of material following measures are need to be undertaken:

- Adequate drainage system shall be provided to prevent the flooding of the excavated area
- At the stockpiling locations, the Contractor shall construct sediment barriers to prevent the erosion of excavated material due to runoff
- Construction of offices, laboratory, workshop and rest places shall be done in the up-wind of the plant to minimize the adverse impact due to dust and noise.
- The access road to the plant shall be constructed taking into consideration location of units and also slope of the ground to regulate the vehicle movement within the plant.
- In case of storage of blasting material, all precautions shall be taken as per The Explosive Rules, 1983.

QUARRY OPERATIONS INCLUDING SAFETY

- Overburden shall be removed and disposed inline with Guidelines for Debris Disposal Site and management giving in Appendix-8.4.

- ii) During excavation, slopes shall be flatter than 20 degrees to prevent their sliding. Incises where quarry strata are good and where chances of sliding are less this restriction can be ignored.
- iii) Incase of blasting, procedure and safety measures shall be taken as per The Explosive Rules, 1983
- iv) The contractor shall ensure that all workers related safety measures shall be done as per guidelines for Workers and Safety attached as Appendix-8.12.
- v) The Contractor shall ensure maintenance of crushers regularly as per manufacturer's recommendation.

Topsoil will be excavated and preserved during transportation of the material measures shall be taken to minimize the generation of dust and prevent accidents.

The EO and the Supervision Consultant shall review the quarry site for the management measures during quarry operation, including the compliance to pollution norms.

POST CONSTRUCTION STAGE

The Contractor shall restore all haul roads constructed for transporting the material from the quarries to construction site to their original state.

The EO and the Supervision Consultant shall be entrusted the responsibility of reviewing the quarry site for the progress of implementation of Redevelopment Plan. These shall include the following two cases;

- Redevelopment of quarries opened by the Contractor for the project
- Redevelopment of existing quarries operated by other agencies

In the first case, the Contractor shall be responsible for the Redevelopment Plan prior to completion after five years, during the defect liability period. The EO shall be responsible for reviewing this case of redevelopment prior to the issuing the defect liability certificate.

In the second case, the redevelopment of exhaust quarry shall be the responsibility of the agency providing the permit to ensure the implementation of Redevelopment Plan.

There are three possibilities:

Case I- If the quarry is an existing one and is managed directly by the Contractor.

Case II -If the quarry is an existing one and is managed directly by a sub-contractor from whom the Contractor is sourcing the materials.

Case III - If the quarry is a new one and is managed directly by the Contractor from whom the contractor is sourcing the materials.

ANNEXURE 3.4: GUIDELINES FOR SITING, MANAGEMENT AND REDEVELOPMENT OF BORROW AREAS MANAGEMENT

Borrow areas will be finalized either from the list of locations recommended by DPR consultants or new areas identified by contractor. The finalization of locations identified by DPR consultant or identified by contractor depends upon the formal agreement between landowners and contractor and its suitability from civil engineering as well as environmental consideration. Meeting the guidelines/notifications as stipulated from time to time by the Ministry of Environment and Forests, Government of India, and local bodies, as applicable shall be the sole responsibility of the contractor.

There will be three number of borrow areas for SH 4 considering one borrow areas at about 30 km interval. Total length of SH 04 is 90.90 km.

Besides this certain precautions have to be taken to restrict unauthorized borrowing by the contractor. No borrow area shall be opened without permission of the Engineer/EO. The engineer in addition to the established practices, rules and regulation will also consider following criteria before approving the Borrow areas.

- (1) The borrow area should not be located in cultivable land unless unavoidable i.e. no suitable uncultivable land in the vicinity for borrowing or private landowners are willing to allow borrowing in their fields.
- (2) Along the roadside, borrow pits should be located 5m away from the toe line.
- (3) The loss of productive and agriculture soil should be minimum.
- (4) The loss of vegetation is almost nil or minimum.
- (5) Sufficient quality of soil is available.
- (6) The Contractor will ensure that suitable earth is available.

After identification of borrow areas based on guidelines. Contractor will fill reporting format as under and submit the same for approval to the “Engineer” Once approved the contractor will adhere to the recommendation for borrow area to the satisfaction of Engineer.

- (1) In no case the depth of borrow area should exceed 2m from the existing ground level.
- (2) Borrow pits slope should be maintained, no steeper than 1 Vertical: 4 Horizontal.
- (3) In case of cultivable land, top soil (15cm) should be preserved and stockpiled.
- (4) Ridges of not less than 8m width should be left at intervals not exceeding 300m. Small drains to be cut through the ridges to facilitate drainage
- (5) Water pooling to be avoided/managed so that no disease spread due to water stagnation.
- (6) Borrow pits should be located at least 1000m away from settlements.
- (7) Precautionary measures as the covering of vehicles will be taken to avoid spillage during transportation of borrow area.

- (8) The unpaved surfaces used for the haulage of borrow materials should be maintained properly for dust suppression.
- (9) Haulage of material to embankments or other areas of fill shall proceed only when sufficient spreading and compaction facility is operating at the place of deposition, to minimize dust pollution.
- (10) Borrow pits located near settlements will be re-developed immediately after borrowing is completed. If spoils are dumped, that will be covered with a layers of stockpiled topsoil in accordance with compliance requirements with respect MOEF/SPCB guidelines
- (11) Redevelopment of the borrow areas to mitigate the impact will be the responsibility of the contractor. The contractor shall evolve site-specific redevelopment plans for each borrows area locations, which shall be implemented after the approval of the Engineer.
- (12) Borrow area near to any surface water body will be at least at a distance of 15m from the toe of the bank or high flood level, whichever is maximum.
- (13) During rains appropriate measures to be taken to minimize soil erosion, silt fencing to be provided as directed by Engineer/EO.
- (14) Borrow areas might be used for aquaculture in case landowner wants such development. In that case, such borrow area will be photographed after their post use restoration and Environment Expert of Supervision Consultant will certify the post use redevelopment.

The Contractor will keep record of photographs of various stages i.e., before using materials from the location (pre-project), for the period borrowing activities (construction Phase) and after rehabilitation (post development), to ascertain the pre and post borrowing status of the area.

ANNEXURE 3.5: GUIDELINES FOR SITING AND MANAGEMENT OF DEBRIS DISPOSAL SITES

The locations of Disposal sites have to be selected such that:

- Productive land to be avoided and available wasteland to be given preference.
- Disposal sites to be located at least 1000m away from sensitive locations like Settlements, Water body, notified forest areas, Sanctuaries or any other sensitive locations.
- Should be located in the downwind side of nearest settlement locations.
- Disposal sites do not contaminate any water sources, rivers etc for this, site should be located away from water body and disposal site should be lined properly to prevent infiltration of water.
- Public perception about the location of debris disposal site has to be obtained before finalizing the location.
- Permission from the Villager/local community is to be obtained in writing by contractor for finalising the disposal site identified.
- The Plan must be approved by EO/Supervision Consultant and PIU- TNRSP.

PRECAUTIONS TO BE ADOPTED DURING DISPOSAL OF DEBRIS / WASTE MATERIAL

The contractor shall take the following precautions while disposing off the waste material

- During the site clearance and disposal of debris, the contractor will take full care to ensure that public or private properties are not damaged/affected, there is no dwellings below the dumpsite and that the traffic is not interrupted.
- Contractor will dispose off debris only to the identified places or at other places only with prior permission of Engineer/EO.
- In the event of any spoil or debris from the sites being deposited on any adjacent land, the contractor will immediately remove all such spoil debris and restore the affected area to its original state to the satisfaction of the Engineer/EO.
- The contractor will at all times ensure that the entire existing drains within and adjacent to the site are kept safe and free from any debris.
- Contractor will utilize effective water sprays during the delivery and handling of materials when dust is likely to be created and to dampen stored materials during dry and windy weather.
- Materials having the potential to produce dust will not be loaded to a level higher than the side and tail boards and will be covered with a tarpaulin in good condition.
- Care should always be taken to maintain the hydrological flow in the area.

REHABILITATION OF DISPOSAL SITES

The dumpsites filled only up to the ground level could be rehabilitated as per guidelines below and to be decided by the engineer and the supervision consultant

- The dumpsites have to be suitably rehabilitated by planting local species of shrubs and other plants. Local species of trees has also to be planted so that the landscape is coherent and is in harmony with its various components.
- In cases where a dumpsite is near to the local village community settlements, it could be converted into a play field by spreading the dump material evenly on the ground. Such playground could be made coherent with the landscape by planting trees all along the periphery of the playground.

- Material excavated for foundation of bridge works should not be dumped in the water course; if same has to be refilled then precaution has to be taken so that the excavated material should not be carried away by flowing/rainy water, thereby silting the water course.
- Care should always be taken to maintain the hydrological flow in the area.

ANNEXURE 3.6 GUIDELINES FOR PREPARING COMPREHENSIVE WASTE MANAGEMENT PLAN

A. OVERVIEW

A comprehensive waste management plan shall be prepared by the Contractor prior to initiation of any works. The purpose of the plan is to provide standardized procedures for the clearance, removal and disposal of debris caused by major debris / waste generated during the construction work as well as to establish the most efficient and cost effective methods to resolve debris disposal issues.

B. PREPARATION OF COMPREHENSIVE WASTE MANAGEMENT PLAN

The Contractor should prepare a Comprehensive Waste Management Plan to be submitted to CSC for approval prior to setting up of construction and labour camp and it should comprise the following details:

- ~ Categorization of waste into degradable, biodegradable and hazardous categories and list of different types of waste that falls in each of these categories.
- ~ Estimates about the quantity of waste generated in each category and type of storage units required.
- ~ Detail the provisions for storage and handling of waste until disposed. A plan of the respective camps / areas like construction camp, labour camp etc. to be attached indicating in it the space allocated for storage and handling of wastes.
- ~ Detail the precautions to be taken while storing, handling and disposing each type of waste, trainings to be imparted to workers to create awareness about waste management.
- ~ Details of each debris disposal site: Copy of approved site identification report along with location plan on a village map or an FMB, showing the debris disposal sites, site, its survey no., access road, project stretch, distance from the project stretch, surrounding features and land use like residences, agricultural land, water bodies etc., photograph of the site showing the topography and other existing features.

C. TRAINING FOR PROJECT STAFF AND WORKERS

All staff and workers involved in the highway construction should be imparted training about comprehensive waste management plan including the need for such a plan, its components and measures adopted by the Contractor for implementing it. In addition, all personnel involved should be made aware about various steps and measures each of them has to follow so as to ensure the compliance to the comprehensive waste management plan.

D. PRECAUTIONS TO BE ADOPTED DURING DISPOSAL OF DEBRIS/WASTE MATERIAL

The Contractor shall take the following precautions during transportation and disposal of debris/waste material:

- ~ A register should be kept for recording the details of the waste generated and their disposal.
- ~ The pre-designated disposal sites should be a part of Comprehensive Solid Waste Management

Plan and should be identified as per the EMP clauses prior to initiation of any work on a particular section of the road.

- ~ The Contractor will take full care to ensure that public or private properties are not damaged/affected during the site clearance for disposal of debris and the traffic is not interrupted.
- ~ All arrangements for transportation during dismantling and clearing debris, considered incidental to the work, will be implemented by the Contractor in a planned manner as approved and directed by the CSC.
- ~ In the event of any accidental spill or spread of wastes onto adjacent parcels of land, the Contractor will immediately remove all such waste material/s and restore the affected area to its original state to the satisfaction of CSC.
- ~ Contractor should ensure that any spoils/materials unsuitable for embankment fill shall not be disposed off near any water course; water body; agricultural land; natural habitats like grass lands, wet lands, flood plains, forests etc. pasture; eroded slopes; and in ditches, which may pollute the surrounding including water sources.
- ~ Contractor should ensure effective water sprinkling during the handling and transportation of materials where dust is likely to be created.
- ~ Materials having the potential to produce dust will not be loaded beyond the side and tail board level and will be covered with a tarpaulin in good condition.
- ~ Any diversion required for traffic during disposal of debris shall be provided with traffic control signals and barriers after discussion with the local body and as approved by CSC.
- ~ During the debris disposal, Contractor will take care of surrounding features and avoid any damage to trees and properties.
- ~ Surplus fly ash, bottom ash and lime, if any, transported for use on this corridor shall not be left open and dumped at any disposal site. Contractor shall take care of such residual materials for use at any other location/s of new embankment construction work with proper protection measures
- ~ No hazardous and contagious waste material shall be disposed at such locations.

E. WASTE DISPOSAL IN CONSTRUCTION CAMP

- ~ Concrete flooring and oil interceptors should be provided for hot mix plant area, workshops, vehicle washing and fuel handling area.
- ~ POL (petroleum, oil and lubricants) waste shall be stored safely in separate containers and should be disposed off by transfer only to recycler/ re-refiners possessing valid authorization from the State Pollution Control Board and valid registration from the Central Pollution Control Board.
- ~ Used lead batteries, if any, should be disposed as per the Batteries (Management and Handling) Rules 2001.
- ~ Water separated and collected from oil interceptor should be reused for dust suppression.

- ~ There should be a register to record the details of the oil wastes generated at the workshops and oil storage areas.
- ~ The Contractor will provide separate garbage bins in the camps and ensure that these are regularly emptied and disposed off in safe and scientific manner as per the Comprehensive Solid Waste Management Plans approved by the CSC.
- ~ No incineration or burning of wastes shall be carried out.
- ~ Discarded plastic bags, paper and paper products, bottles, packaging material, gunny bags, hessian, metal containers, strips and scraps of metal, PVC pipes, rubber and poly urethane foam, auto mobile spares, tubes, tires, belts, filters, waste oil, drums and other such materials shall be either reused or will be sold /given out for recycling.
- ~ Septic tank must be provided for toilets and the sludge should be cleared by municipal exhausters.

F. WASTE DISPOSAL IN LABOUR CAMP

- ~ The Contractor should provide separate garbage bins in the camps for bio-degradable, nondegradable and domestic hazardous waste and ensure that these are regularly emptied and disposed off in safe and scientific manner.
- ~ The disposal of kitchen waste and other biodegradable matter shall be carried out in pits covered with a layer of earth within the camp site to avoid smell and pests. The Contractor may use the compost from such wastes as manure in the plantation sites.
- ~ Non-biodegradable waste like discarded plastic bags, paper and paper products, bottles, packaging material, gunny bags, hessian, metal containers, strips and scraps of metal, PVC pipes, rubber and poly urethane foam, auto mobile spares, tubes, tires, belts, filters, waste oil, drums and other such materials shall be either reused or should be sold /given out for recycling.
- ~ No incineration or burning of wastes should be carried out.
- ~ Effluent treatment system like septic tank with soak pits provided for toilets should be sited, designed, built and operated in such a way that no health hazard occurs and no pollution to the air, ground or adjacent watercourses takes place.
- ~ Soak pits must be provided to collect waste water from bathrooms and kitchen.

G. DISPOSAL OF BITUMINOUS WASTE

- ~ The bituminous waste should be used for development of roads inside the construction camps, haul roads or for filling pot holes in rural roads.
- ~ At locations identified for disposal of residual bituminous wastes, the disposal will be carried out over a 60 mm thick layer of rammed clay so as to eliminate the possibility of leaching of wastes into the ground water.
- ~ The Contractor will suitably dispose off unutilized non-toxic debris either through filling up of borrows areas located in wasteland or at pre-designated disposal sites, subject to the approval of CSC.

- ~ Debris generated from pile driving or other construction activities along the rivers and streams drainage channels shall be carefully disposed in such a manner that it does not flow into the surface water bodies or form puddles in the area.

H. DISPOSAL OF NON BITUMINOUS WASTE

- ~ Non-bituminous wastes other than fly ash may be dumped in borrow pits (preferably located in barren lands) where such borrow pits are not suitable to be re-developed as an economic source like pisci-culture or a source of irrigation. Such borrow pits can be filled up with non-bitumen wastes and then covered with a minimum 30cm layer of the soil, where plantation of trees and shrubs will be taken-up by the Contractor as a part of site rehabilitation.
- ~ Local tree species suitable for such re-habitation work shall be selected in consultation with local community.

I. REUSE OF DEBRIS GENERATED FROM DISMANTLING STRUCTURES AND ROAD SURFACE

Debris generated due to the dismantling of existing road will be suitably reused in the proposed construction as follows

- ~ Eighty percent (80%) of the sub-grade excavated from the existing road surface, excluding the scarified layer of bitumen, shall be reused in the civil works after improving the soil below the sub grade through addition of sand and suitable cementing material for qualitative up-gradation.
- ~ The dismantled scraps of bitumen will be utilized for the paving of cross roads, access roads and paving works in construction sites and campus, temporary traffic diversions, haulage routes, parking areas along the corridor or in any other manner approved by the Environmental Officer of SC

ANNEXURE 3.7 GUIDELINES FOR TOP SOIL CONSERVATION AND REUSE

The top soil from all sites including road side widening and working area, cutting areas, quarry sites, construction camps, labour camps, haul roads in agricultural fields (if any) and areas to be permanently covered shall be stripped to a specified depth of 15 cm and stored in stock piles for reuse. A portion of temporarily acquired area and/or RoW edges will be earmarked for storing top soil. The locations for stacking will be pre-identified in consultation and with approval of environmental officer of SC. The following precautionary measures will be taken by the Contractor to preserve the stock piles till they are re-used:

Stockpiles will be such that the slope doesn't exceed 1:2 (vertical to horizontal), and height is restricted to 2 m.

~To retain soil and allow percolation of water, the edges of pile will be protected by silt fencing.

~Multiple handling kept to a minimum to ensure that no compaction occurs. ~Such stockpiles shall be covered with empty gunny bags or will be planted with grasses to prevent the loss during rains. Such stockpiled topsoil will be utilized for: ~Covering reclamation sites or other disturbed areas including quarry areas. ~Top dressing and raising turfs in embankment slopes ~Filling up of tree pits ~For developing compensatory afforestation plantation

~ in the agricultural fields of farmers acquired temporarily that needs to be restored. Residual top soil, if there is any, shall be utilized for the plantations works along the road corridor. The utilization as far as possible shall be in the same area from where top soil was removed. The stripping, preservation and reuse shall be carefully inspected, closely supervised and properly recorded by the SC.

ANNEXURE 3.8 GUIDELINES FOR PROVISION OF NOISE BARRIERS

Mitigating the impact of increased noise levels at the sensitive receptor locations includes posting of signs prohibiting the use of horns, constructing a sound insulating wall and, to the extent possible, planting appropriate trees to serve as green noise barriers. Attenuation of sound can be achieved considerably by the combined effect of sound insulating walls and green barriers. Nevertheless the putting of green barriers requires at least 2-5m additional space between the solid barrier and the receptor. Principle of the designed barrier is explained in the design sections. Proposed project mitigation actions are cost effective when compared to the generally recommended expensive double glazed windows.

A. SOUND INSULATING WALLS FOR SILENCE ZONES

The design of a sound insulating wall comprises 23 cm thick brick wall which will act as a sound barrier. The typical cross section for the same is given in Figure 1. This can be provided adjacent to the road corridor where hospitals, medical centre, schools and other educational institutions are affected by the traffic noise.

B. GREEN BARRIERS FOR SILENCE ZONES

These are simply a thick layer of green plantation with limited foliage (eg. Asoka Tree) acting as noise absorbers. These trees may be planted just inside and adjacent to the wall. While contractors will be responsible for the implementation of the civil work, tree plantation will be carried out by the Forest department under the tree-planting scheme of the project. The implementation aspects are provided in the EMP. In addition to the noise mitigation, the thick green layer will act as an air quality filter for traffic emission. A typical green barrier of 100m lengths will have 200 trees in 4 rows.

Noise mitigation techniques will be employed as may be warranted at each of the sensitive receptor sites. Definitive noise levels will be empirically determined at each site and selection of the mitigation technique will be made on a site- specific basis in consultation with property owners. Co-ordination and implementation will be the responsibility of the Environmental officer of the supervision consultants (SC). Mitigation cost has been estimated as a part of the environmental costs of the project.

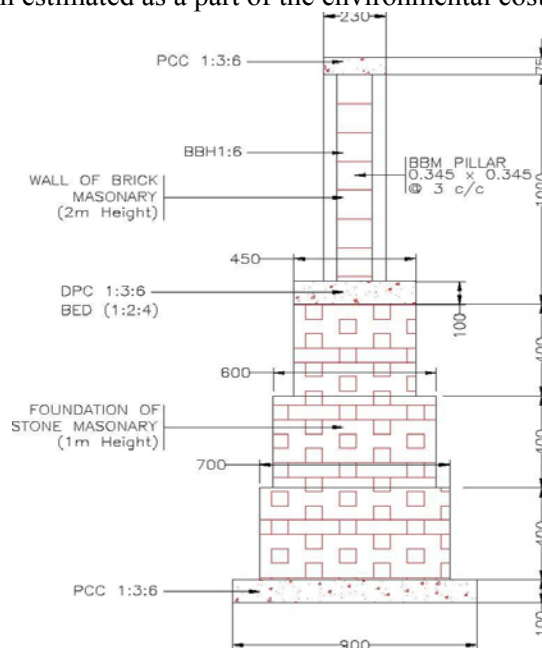

Figure 1. Typical Cross Section of a Noise Barrier

ANNEXURE 3.9: GUIDELINES TO ENSURE WORKERS SAFETY DURING CONSTRUCTION

SAFE LAYOUT IN THE CONSTRUCTION PLANT, CAMP AND QUARRY AREAS

1. Arrange border to perimeter fencing
2. Ensure good visibility and safe access at site entrances
3. Provide adequate warning signs at the entrance and exit where necessary
4. Provide adequate space/area for loading and unloading, storage of materials, plant and machinery
5. Display emergency procedure and statutory notices at conspicuous location
6. Consider welfare facilities required
7. Provide areas for dumping garbage and other waste materials, and also arrange for their regular clearance.
8. Arrange storage, transport and use of fuel, other flammable materials and explosives in line with the license requirements to be obtained from appropriate authorities
9. Plan emergency assembly points, fire escape routes and locate fire-fighting equipment
10. Provide access roads and plant movement areas within the site.
11. Ensure the availability of first aid facilities and display notices at the various works to show the location of these facilities
12. Provide proper drainage and sewage & drainage facilities

HOUSE KEEPING PRACTICES

1. Maintain washrooms and canteens clean
2. Keep all walkways clear and unobstructed at all times
3. Ensure that spillages of oil and greasy
4. Stack raw materials and finished products clear of walkways or inside roads
5. Do not leave tools on the floor or in any location where they can be easily dislodged
6. Keep windows and light fitting clean
7. Maintain the workplace floors dry and in a non-slippery condition
8. Provide and maintain proper drainage system to prevent water ponding
9. Use metal bins for oily and greasy rags and store all flammable materials in appropriate bins, racks or cabinets. Ensure that the metal bins for storing oily and grease rags should be covered with lids.
10. Ensure that protruding nails in boards or walls are moved or bent over so that they do not constitute a hazard to people
11. Make sure that hazardous/dangerous chemicals are kept in the goods stores with the appropriate labelling, display of the material-safety-data-sheet (MSDS) and other precautionary measures
12. Display 'no smoking' signs in areas with high fire risks, e.g. paint stores, wood working area and others

TREE FELLING

- Use hard hats during tree felling

- Ensure tools such as the axes are in good condition
- Determine proper foot and body position when using the axe. Do not cut above your head
- Wear appropriate foot protection
- Carry a first aid kit to the site
- Determine possible hazards in the area, e.g. electrical or telephone or other utility lines
- Prior to felling, determine the safest direction for the fall
- Determine the proper hinge size before directing the tree fall.

NOISE HAZARDS AND ITS CONTROL

1. Note that indications of noise levels are:
 - You have to shout to be heard;
 - Your hearing is dulled just after work;
 - You get head noises or ringing in the ears after work;
 - You have difficulty hearing people while others are talking
2. Use sound level meters to measure. If the sound level exceeds 85 dB(A), then preventive measures should be taken
3. Make personnel aware of noisy areas by using suitable warning signs and insisting that ear protectors should necessarily be worn.
4. Reduce noise at source by improved maintenance, replacing noisy machines, screening with noise absorbing material, making changes to the process/equipment, controlling machine speeds, ensuring that two noise-generating machines are not running at the same time, using cutting oils and hydraulic breakers.
5. Appoint a competent person to carry out a detailed noise assessment of the site, designate ear protection zone, and give instructions on the necessary precautionary measures to be observed by site personnel, including the use of suitable type of ear protections.
6. Wear and maintain ear muffs and ear plugs as required
7. In construction or repair work, noise should be kept to a low-level bearing in mind the disturbance to local residents.

ROAD WORKS

1. The use of signage is most important to caution the road users of possible unsafe conditions due to the road works.
2. Use the appropriate signage devices as required by the site conditions/situation. The devices include regulatory signs, delineators, barricades, cones, pavement markings, lanterns and traffic control lights.
3. In using signs, make sure that they are (i) simple, easy-to-understand and convey only one message, (ii) luminescent and with reflective properties, and (iii) broad, prominent and of appropriate size.
4. In using barricades, make sure that you keep traffic away from work areas and you guide the drivers to keep along a safe, alternative path.
5. Ensure that proper personal protective equipment (PPE) is provided to all the workers.
6. Cover existing road signs and install new ones at appropriate locations taking into account the distances that would be required and reaction times.

7. Plan layout and traffic management so that hazard is not created.
8. Deploy flagmen, who control traffic at the work areas.
9. Flagmen should wear reflective safety vests along with hard hats
10. If required, use wireless devices for flagmen to co-ordinate from either ends of the road, where works are being carried out.

ELECTRICAL HAZARDS IN CONSTRUCTION AREAS

1. Treat all wires as live wires
2. Never touch dangling wires, but report them to your manager
3. Unless you are a qualified electrician, do not attempt electrical repairs
4. Never use electrical equipment if you hands are wet or you are standing in water
5. If electrical equipment is sparking or smoking, turn the power off and report the condition to your supervisor
6. Never use electrical wires that have physical damage
7. Never allow equipment or traffic to run over electrical wires.

USE AND STORAGE OF GAS/LPG

1. Store filled gas/LPG cylinder in the open area, i.e. outside of the building
2. Transport, store, use and secure cylinders in upright position
3. Ensure proper ventilation at the ground level in locations where gas/LPG is in use
4. Avoid physical damage to the cylinders
5. Never weld or cut on or near the cylinders
6. Store empty cylinders secured and upright
7. Make sure that the cylinder is closed immediately after use
8. Investigate immediately if there is the smell of LPG or gas
9. Never use distanced gas/LPG on site.
10. Make sure that there is no other unrelated fire in the vicinity of the cylinder

OPERATION OF EXCAVATORS

1. Ensure that excavators are operated by authorized persons who have been adequately trained.
2. Prevent unauthorized movement or use of the excavators
3. Check regularly and maintain the machine thoroughly
4. Ensure that all relevant information, including those related to instruction, training, supervision and safe system of work are provided to the operators.
5. Ensure that the operation and maintenance manuals, manufacturer's specifications, inspection and maintenance log books are provided for the use of the mechanics, service engineers or other safety personnel during periodic maintenance, inspection and examination.
6. During tipping or running alongside the trenches, excavators must be provided with stop blocks.
7. Excavators must be rested on firm ground during operation

8. Avoid operating the machine too close to an overhang, deep ditch or hole and be alert to potential carving edges, falling rocks and slides, rough terrain and obstacles.
9. Locate and identify underground services by checking with all utility companies before excavations.
10. Ensure that all excavations are supervised by experienced and competent persons.
11. When reversing or in case the operator's view is restricted, adequate supervision and signalling should be provided.
12. Ensure that the type and capacity of the excavator are properly chosen for the intended purposes and site conditions. Never use a machine for any purposes other than it is designed for.
13. Check and report for excessive wear and any breakage of the bucket, blade, edge, tooth and other working tools of the excavator.
14. Check that all linkages/hinges are properly lubricated and ensure that the linkage pins are secured. Never use improper linkage pins.
15. Never dismount or mount a moving machine
16. Work only with adequate ventilation and lighting
17. Ensure that the protective front screen of the driving cabin is fixed in position during excavations to avoid eye injury to the operator.
18. Ensure switch-off of the unattended vehicle.

OPERATION OF TRUCKS AND DUMPERS

1. Ensure that only trained, authorized and licensed drivers operate the vehicles
2. Enlist the help of another worker before reversing the vehicle
3. Switch-off the engine of an unattended vehicle
4. Lower the tipping bodies when the machine is unattended, but if it is necessary to leave them in the raised position they should be blocked to prevent their fall.
5. Wear safety boots or shoes to avoid injuries during loading and unloading.
6. Carry out periodic servicing to the manufacturer's requirements. All records of maintenance and repairs should be in writing or kept on site.
7. Keep the vehicle tidy and the cabin free from tools and material, which might obstruct the controls.
8. Keep to speed limits.
9. No passenger should be carried on a dumper except the driver
10. Never drive the vehicle across a slope
11. Provide stop blocks when the vehicle is tipping into or running alongside excavations
12. Do not overload the vehicle.
13. Carry only well secured loads
14. Park only on level ground, in neutral with the parking brake applied
15. Never mount or dismount from a moving vehicle

GAS WELDING

1. Use the following personal protective equipment during welding
 - Face or hand shield fitted with filters

- Goggles, particularly when chipping slag
 - Gloves long enough to protect wrists and forearms against heats, sparks, molten metal and radiation
 - High-top boots to prevent sparks from entering footwear.
2. Screen of the work area with sturdy opaque or translucent materials because glare can cause eye injury.
 3. Key for opening the acetylene cylinder valve must be on the valve stem while the cylinder is in use so that the cylinder valve may be immediately shut-off in an emergency.
 4. Ventilate the workplace using air blowers and exhaust fans to remove poisonous fumes and gases that are given off during welding
 5. Take precautions against flying sparks and hot slag where welding is being done near flammable materials and check the area before leaving.
 6. Do not weld material degreased with solvents until completely dry.
 7. Do not use gas cylinders for supporting work or as rollers
 8. Do not use oil grease on oxygen cylinder fittings
 9. Do not use cylinders with damaged valves.
 10. Do not use too much force if valves are stuck.
 11. Replace valve caps after use
 12. Search for leaks in equipment by using a solution of soapy water.
 13. Shut the cylinder valve if acetylene from a cylinder catches fire at the valve or regulator due to leakage at a connection.
 14. Treat all gas cylinders as “full” unless you are sure otherwise.
 15. Never attempt to transfer acetylene from one cylinder to another or attempt to refill an acetylene cylinder.
 16. Place portable fire extinguishers near the welding area
 17. Secure all cylinders against accidental displacement.
 18. Always lift gas cylinders. Do not slide them along the ground or drop them from trucks.
 19. Keep gas cylinders in vertical position both in storage and when in use
 20. Keep the work place dry, secure, free from combustible materials and obstruction.
 21. Store the acetylene and oxygen cylinders separately, and in a proper store.
 22. Keep the gas cylinders from source of heat, flammable materials, corrosive chemicals and fumes.

MANUAL HANDLING AND LIFTING

1. Use mechanical equipment in place of manual handling as far as possible.
2. Assess the manpower required to handle or lift the load safely and arrange the manpower accordingly.
3. In handling hazardous materials, the workers shall be informed of the hazards and safety precautions.
4. All relevant persons shall be trained in the proper methods of lifting and carrying.
5. Where team work is required, select the persons whose ages and physical builds are compatible for teaming up. Coordinate the actions of the team members by giving necessary instructions.

6. Always lighten or suitably shape the load for manual handling as far as possible. Keep a look out for splinters, sharp edges, loose banding and nails.
7. Clear path or obstruction and tripping hazards.
8. Stack and secure goods safely on trucks, otherwise they fall off and injure passers-by.
9. Use personal protective equipment such as gloves, safety shoes, etc.
10. Adopt the following procedure when you lift a load:
11. Stand close to the object. Have a firm footing with feet spread on either side of the road.
12. Bend the knees and keep your back as straight as you can.
13. Grasp object firmly. Be sure grip will not slip.
14. Breathe in and throw the shoulder backwards.
15. Straighten the legs, continuing to keep the back as straight as you can.
16. Hold object firmly close to the body.
17. Always lift smoothly. Avoid jerky motions. Turn with feet instead of twisting the back.

HANDLING CHEMICALS AND HAZARDOUS SUBSTANCES

1. Always substitute hazardous chemicals with harmless or less hazardous ones wherever possible.
2. Enclose the process using chemicals or provide other engineering controls such as local exhaust ventilation, a fume cupboard or a safety cabinet.
3. Exercise great care in the storage and use of chemicals because they may be explosive, poisonous, corrosive or combustible.
4. Separate different chemicals physically.
5. Store chemicals classified as dangerous goods in a properly constructed and approved goods store. Keep proper records of all chemicals and hazardous substances delivered, stored and used on site.
6. Consider unknown substances and liquids as dangerous until proven otherwise.
7. All containers should be clearly labelled to indicate contents. Never use a wrongly labelled container for chemicals.
8. Prohibit smoking in the vicinity of dangerous chemicals.
9. Ensure that you are wearing the correct personal protective equipment before you handle chemicals.
10. Maintain the Material Safety Data Sheet of all chemicals for reference on safety precautions to be taken and the use of suitable PPE.
11. When opening containers, hold a rag over the cap or lid, as some volatile liquids tend to spurt up when released.
12. Wash before you eat and do not eat at the work place.
13. If the skin is splashed with a chemical, rinse it immediately with plenty of clean water. Eye should be flushed thoroughly with water followed by immediate medical attention.
14. Eye fountain, emergency shower and breathing apparatus should be available in the vicinity of the workplace.
15. Safety instructions for handling emergency situations should be displayed prominently at both the storage and use locations.

FIRST AID

1. Provide first aid boxes at every site.

2. Ensure that training on the use of the first aid box is provided to a handful of staff working in the site.
3. Display the list of persons who are trained on providing first aid.
4. Ensure that every first aid box is marked plainly “First Aid” in English and local language.
5. The responsible person or first aider should replenish the contents of the first aid box as necessary.

PERSONAL PROTECTIVE EQUIPMENT

General

1. Consider the provision of personal protective equipment only after all measures for removing or controlling safety hazards have been provided reasonably impractical.
2. Ensure that sufficient personal protective equipment is provided and that they are readily available for every person who may need to use them.
3. The management should ensure that all persons make full and proper use of the personal protective equipment provided.
4. Provide instruction and training in the proper use and care of any specific protective equipment where necessary
5. Do not wilfully misuse, interfere with or ill-treat any protective clothing and equipment provided.
6. Ensure that the personal protective equipment is in good condition. Report immediately any damage to the management for replacement. Always keep the personal protective equipment as clean as possible.

Eye protection

1. Issue eye protection equipment where there is a foreseeable risk of eye injury
2. Ensure an adequate supply of goggles/shields is available.
3. Keep the goggles clean and make sure they are good fit.
4. Do not watch welding operations unless your eyes are protected from the damaging effect of flash.

Head Protection

1. No person shall enter a construction site unless he is wearing a suitable safety helmet
2. Wear a safety helmet:
 - When there is the risk of being hit by falling objects
 - While on or near a construction site
 - During adverse weather conditions
 - When in any area designated as a “hard hat” area.
3. Provide identification labels to all helmets in some way to prevent random exchange among wearers, with one helmet exclusive to each person.
4. Inspect helmets for cracks or sign of impact or rough treatment before each usage. Destroy, remove and replace all worn, defective or damaged helmets.

Hearing Protection

1. Provide ear plugs or ear muffs as required. Use re-usable ear plugs when the reduction required (15-25 dBA) is not excessive. Use ear muffs where a large attenuation of up to 40 dBA is demanded.
2. Do not use dry cotton wool for hearing protection because it cannot provide any.

3. Provide disposable ear plugs for infrequent visitors and ensure that they are never re-used.
4. Provide re-usable ear plugs for those who need to work continuously for a long period in a high noise area.
5. Use ear muffs with replaceable ear cushions because they deteriorate with age or may be damaged in use.
6. Avoid wearing spectacles with ear muffs.
7. Use soap and water or the recommended solvent for cleaning ear muffs.
8. Provide ear muffs for those who may need to get in and out of a high noise area frequently.

RESPIRATORY PROTECTIVE EQUIPMENT

1. Wear suitable respirable for protection when there is a potential for small particles entering the lungs, e.g. emptying of cement bags.
2. Ensure that the explanatory can provide adequate protection.
3. Provide training to all persons using the respirators for their correct fitting, use, limitations and symptoms of exposure.
4. Clean and inspect all respirators before and after use.
5. Store respirators properly when not in use.

Safety Footwear

1. Wear suitable footwear for work
2. Use safety footwear on site or in other dangerous areas
3. Wear suitable safety shoes or ankle boots when working anywhere where there is high risk of foot injuries from slippery or uneven ground, sharp objects, falling objects, etc.
4. All safety footwear, including safety shoes, ankle boots and rubber boots, should be fitted with steel toecaps.
5. Avoid wearing flip flops, high heeled shoes, slippers, light sport shoes in situations where there is a risk of foot injury.
6. Keep shoe lace knots tight.

Hand Protection

1. Wear suitable gloves for selected activities such as welding & cutting and manual handling of materials & equipment.
2. Do not wear gloves where there is a risk of them becoming entangled in moving parts of machinery
3. Wash hands properly with disinfectant soap and clean water before drinking, eating or smoking. Wash hands immediately after each operation on site when the situation warrants.

FIRE PREVENTION, FIGHTING AND EQUIPMENT

Before fire breaks cut

1. Store flammable material in proper areas having adequate fire protection systems.
2. Display sufficient warning signs.
3. Train selected personnel to use these fire extinguishers
4. Inspect fire extinguishers regularly and replace as necessary

5. Fire escape route should be kept clear at all times and clearly indicated.
6. Know the escape route and assembly point.
7. Display escape route maps prominently on each floor
8. Carryout fire drill regularly. Designate fire officers
9. Install fire alarm wherever required and test regularly.
10. Provide sufficient exit signs at prominent locations for directing people to the escape staircases and routes.

When fire breaks out.

1. Alert all persons
2. Put off the fire with appropriate fire extinguishers only when you are sure that you are safe to do so.
3. Escape if you are in danger through the fire escape route to assembly point
4. Fire officers to carryout head count at the assembly point.

Incident and accident investigations

1. Carryout the investigation as quickly as possible.
2. Conduct interviews with as many witnesses as necessary
3. Do not rely on any one sole source of evidence
4. Use the following tools:
Checklists for obtaining basic and typical information for accidents
 - Notebook
 - Tape records
 - Camera
 - Measuring tape
 - Special equipment for the particular investigation
5. Obtain answers to the following questions:
 - When did the accident occur?
 - Where did it occur?
 - Who was injured and what was damaged?
 - What caused the accident?
 - Why did it occur?
 - How could it have been prevented?
 - How can a recurrence be prevented?
6. Prepare a short but sufficient investigation report that contains the following:
 - A summary of what had happened
 - A summary of events prior to the accident
 - Information gathered during the investigation
 - Details of witnesses

- Information on injury or loss sustained
- Conclusions and possible causes of the accident
- Recommendations to prevent recurrence
- Supporting materials (photos, diagrams, etc.)

WORKERS SAFETY DURING CONSTRUCTION

Sl No.	Stage and Nature of Construction Hazard	Safety measures expected to be taken by the Contractors and Site Engineers
1	Excavation in soft loose & slushy soil above 2.00 m depth sliding of earth or collapsing of sides.	The Excavation beyond 1.5 m to 2.00 m to be done in steps of minimum 500 mm offsets as shown in Clause 2.18.2(b) and also planking and strutting should be done as in Clause 2.19.1.
2	Excavation in slippery area (water logged) – The labour may fall or machinery on site may slip.	Try to dewater the area and spread minimum 150 mm thick sand layer to avoid slipping
3	Excavation in Rock where chiselling is involved – The fall of hammer may injure the hand, small rock pieces may injure the eyes and legs.	For hammer work, only experienced and skilled labour should be employed. Chisel should not be allowed to be held by hand, while hammering but chisel holding clamp should be provided. The labour should be provided with goggles and leg cover to protect eyes and legs, from injuries due to small rock pieces.
4	Excavation in Rock where blasting is involved - Careless handling may lead to injury to main worker or a passerby.	The work of blasting should be entrusted to only experienced persons. Provide sufficient length of fuse to give ample margin of time from the time of lighting to the time of explosion. A danger zone at least 180m diameter is to be flagged off 10 minutes before actual firing. All workmen should be sent away from danger zone except the firing man, who should be provided with a whistle.
5	Excavation for drain across road or manhole adjacent to a road – chances of a passer by falling into the excavated portion	The area should be well barricaded & a red lamp provided at night. A watchman should be deputed to prevent any movement of persons, or vehicles.
6	During Excavation or sometimes even while concreting – Snake bites or Scorpion stings –	In places where the movement of snakes are more the contractor should provide the labour with gum boots, gloves etc. and also make snake antidotes available on site. A particular care that has to be taken on such site is to always keep a vehicle available on site to rush the patient to a doctor. This applies to snake stinged patients as well.
7	Centring (form-work) and scaffolding – Form-work collapse while concreting or just before concreting especially when wooden ballies are used.	Many a times ballies joined together give way due to weak joint. Hence the use of joined ballies should be restricted. Only 2 joined ballies out of 8 ballies should be allowed. In case of double staging for a Slab at a height, utmost care should be taken to see that the top balli rests on the bottom balli. A particular care that should be taken during each concreting operating of slabs and beams is that, one carpenter and two helpers with spare ballies, nails etc. should be deputed below the slab/beam that is

Sl No.	Stage and Nature of Construction Hazard	Safety measures expected to be taken by the Contractors and Site Engineers
		being concreted to watch any disturbance in the supports of the form-work below during concreting and in case of any doubt the concreting should be stopped immediately and the form work strengthened. Never allow bricks below a balli to make up the required height. This is most dangerous.
8	Form-work for beams and slabs: The bottom of beam collapses and many a times brings down the slab as well, injuring the labour and supervision staff.	This case is noticed when slender ballies are used without bracing. In fact, no concreting should be allowed without bracing at 300 mm above ground, and at mid way, in normal beams & slabs. The bracings should be for the support of beams as well as slabs.
9	Form-work for sides of a slab–The labour just rests his foot on the plank and loses balance and falls resulting a fatal accident.	This is noticed when the carpenter fixes the side shuttering of a slab with a plank just tied by binding wire to the steel reinforcements and by wooden pieces nailed in wall and plank. This is so weak a portion that with little pressure the plank gives way. Hence side shuttering should be done with a direct balli support from ground or floor, and the practice of tying planks with binding wire to the steel reinforcement should be totally avoided. A temporary railing along the periphery of slab will guard the life of labour and supervision staff.
10	Form-work for beams and slabs–Opening the form- work–Accident due to fall of materials during removing the forms.	In fact, this is a most dangerous work. One should be very careful while form-work is removed. Only trained carpenters should be deputed for the work. A safe resting place outside the area of slab as a temporary measure should be constructed from where the Slab can be removed safely. Removal of form-work during night should not be permitted under any circumstances.
11	Scaffolding–Fall of work-man, Supervision Staff, Standing on Chalis not tied properly or tied only at one end. (Chalis mainly made of Bamboos).	This is a very common negligence on the part of labour that do scaffolding work. The Chalis on which they work either span over its complete length or is tied loosely and many a times at one end only. Hence, care must be taken that the Chali do not span over the full length but some middle support should be provided and also the same is tied properly on both ends.
12	Ladders–Balli or bamboo ladders – The horizontal member breaks and the person falls. Sometimes the top face just rests on wall and the whole ladder tilts causing an accident.	The ladders should be strong enough to bear the weight of a labour with materials on head. As far as possible a hand rail should be provided at one end. The horizontal member should be preferably fixed with Bolt& nuts or strong nails. When the ladder is placed across a wall the top portion should be tied firmly to a strong support so that the ladder does not move laterally.
13	Column Reinforcements–Column reinforcements mainly in independent footings collapses – Injury to persons working nearby.	The tendency of bar-benders is to tie the vertical steel with coir rope or 8 mm steel rods as ties on all four sides of the column reinforcement. This method of supporting the column reinforcements results in a weak support.

Sl No.	Stage and Nature of Construction Hazard	Safety measures expected to be taken by the Contractors and Site Engineers
		Hence, the column reinforcements should be supported by strong ballies on all four sides of reinforcements and as far as possible a combined platform should be constructed out of ballies over which the reinforcements can be supported.
14	Concreting chajjas – When chajjas are concreted without care and on opening the form-work the chajja would collapse, causing injury to labour on top or bottom of chajja.	While concreting chajjas care must be taken that the labour does not stand on the reinforcement and disturb the position. Separate scaffolding must be tied over which the labour can stand and work without disturbing the reinforcements. The main reason is in chajja the steel is placed on top face but if the labour stands on the steel, it will bend and come to bottom face and hence the chajja will fall when form-work is removed, thus, causing injury to labour working on top, or bottom.
15	Dismantling–Dismantled materials may fall on passerby or the person engaged in dismantling work may fall due to slipping. The dismantled materials may fall on persons working below.	When work of demolition is to be taken up the area should be closed for all outsiders. No one should be allowed up to 50 m. from the place of demolition. The workers engaged in demolition should be asked to wear safety belts. Helmets must be worn by all the workers engaged in dismantling work. The place should be strictly guarded at night with red lights at prominent places, and watchman should be posted.
16	Electric-Connections/Cables etc. –High tension/L.T. Electric wire passing near the slab structure- while bending, lifting or tying reinforcements the bar benders may sustain the Electric Shock, causing fatal injury.	The work in such places should not be allowed to the workers themselves, but in such position the work must be executed under the strict supervision of a responsible Foreman or a Supervisor.
17	Electric Connections/Cables etc. –Cables below ground may get punctured during excavation & thus electrocute the labour working. Similarly when concreting is in progress the punctured cable may prone to be fatal to the labour.	Before taking up the work all available drawings should be studied, local enquiry to be made to know the position of cables and work in such area should be got executed under strict supervision of an experienced Foreman or a Supervisor.
18	Electric Connections/Cables etc. – Temporary Electric lines near damp walls, near joinery stretched on a considerable length – There is every chance that the wire may get cut due to usage and may develop short circuits/leakages etc. and may electrocute the person touching the wire accidentally.	The Electric wires should be maintained by an electrician who should regularly check up the insulation of wires especially placed near steel items & damp areas. The temporary wiring should be supported properly. As far as possible a good quality wire should be used which may not get damaged easily?
19	Electric and gas welding work – Drilling, polishing work – Done by temporary cables used on a number of works – Due to the fact that the wires are old & when they come in contact with water even in	All wiring works to be inspected by experienced electrician. All wires to be properly insulated and fixed at height on temporary poles. No welding work should be permitted near damp area. The welders to be provided with welder's goggles & gloves. As far as possible

SI No.	Stage and Nature of Construction Hazard	Safety measures expected to be taken by the Contractors and Site Engineers
	the process of curing the surrounding area may get affected due to leakage in the electric current thus causing damage to the workers & supervision staff.	machine in good condition should be used.
20	Construction Machinery & Lifts – Concrete Mixers – Safety precautions. A mixer with hopper tried to be operated by a helper could not release brake in time thus causing injury to the person near hopper- sometimes fatal one.	The Mixers with hopper should be operated by an experienced mixer operator and such mixers should not be allowed to be handled by a helper or a labour.
21	Construction Machinery & Lifts - Lifts - Safety precautions. (1) The lift pit if left unguarded the children of workers may fall in the pit resulting in fatal accident	(1) A brick protection wall of minimum 1.00 m height should be constructed around the Lift Pit, thus, preventing the children going near the pit. A special care should be taken to see that the children are not allowed to come near the machinery.
	(2) The manually operated brakes of the lift failed or the communication between the labour at the top and the liftman failed and thus, the lift was not controlled and resulted in fatal accident.	(2) The condition of the lift must be maintained properly. The lift operator should be well trained. The labour receiving the bucket at top should be smart and active enough to convey the message of stopping & releasing the lift-to-lift operator properly.
22	Water Storage Tank for general use & curing - chances of children of workers falling in the tank with fatal accident.	The water tanks constructed on site should be protected by at least 1.00 m high walls on four sides, so that the children do not fall.
23	Misuse of lift by labour and sometimes supervision staff The lifts that are meant for lifting materials used by labour to go to upper floors – The labour thus travelling many a times get injured.	No person should be allowed to go to upper floors by lifts that are mainly meant for conveying the building materials. Fatal accidents have taken place due to above action of workers.
24	Site Cleaning–Cleaning top floors of buildings – Upper portion of any structure – Throwing waste materials broken concrete pieces, brick bats, sand etc. straightway from top to ground injuring person below or even a passerby.	This dangerous practice should not be allowed at all. The materials should be brought to the ground with the help of lift or the use of rope over pulley with a bucket, thus bringing down materials safely.
25	Bar bending work-Helpers of bar benders to follow short cut method, throw surplus steel pieces from top floors to ground and may cause fatal injuries.	This is a very bad practice. The helpers should bring the rods to ground with the help of lift or rope & pulley.

ANNEXURE 3.10 GUIDELINES FOR PREPARATION OF TRAFFIC MANAGEMENT PLAN

The Contractor shall at all times carry out work on the road in manner creating least interference to the flow of traffic with the satisfactory execution. For all works involving improvements to the existing state highway, the Contractor shall, in accordance with the directives of the CSC, provide and maintain, during execution of the work, a passage for traffic either along a part of the existing carriageway under improvement, or along a temporary diversion constructed close to the state highway. The Contractor shall take prior approval of the CSC regarding traffic arrangements during construction.

A. ENSURING TRAFFIC SAFETY AND CONTROL

Where subject to the approval of the Engineer the execution of the works requires temporary closure of road traffic use, the Contractor shall provide and maintain temporary traffic diversions. The diversions shall generally consist of 200 mm thickness of gravel 4.5 meters wide laid directly upon natural ground and where any additional earthworks are required for this purpose that will be provided under the appropriate payment items.

Where the execution of the works requires single-lane operation on public road, the Contractor shall provide and maintain all necessary barriers, warning signs and traffic control signals to the approval of the Engineer.

With the exception of temporary traffic arrangements or diversions required within the first 4 weeks of the Contract, the Contractor shall submit details of his proposals to the Engineer for approval no less than 4 weeks prior to the temporary arrangement or diversion being required. Details of temporary arrangements or diversions for approval as soon possible after the date of the Letter of Acceptance.

The colour, configuration, size and location of all traffic signs shall be in accordance with the code of practice for road sign. In the absence of any detail or for any missing details, the signs shall be provided as directed by the Engineer (CSC).

The Contractor shall take all necessary measures for the safety of traffic during construction and provide, erect and maintain such barricades, including signs, marking, flags, lights and flagmen as may be required by the Engineer for the formation and protection of traffic approaching or passing through the section of the road under improvement. Before taking up any construction, an agreed phased programme for the diversion of traffic or closer of traffic on the road shall be drawn up in consultation with the SE.

At the points where traffic is to deviate from its normal path (whether on temporary diversion or part width of the Carriageway) the lane width path for traffic shall be clearly marked with the aid of pavement markings, painted drums or a similar device to the directions of the SE. At night, the passage shall be delineated with lanterns or other suitable light source.

One-way traffic operation shall be established whenever the traffic is to be passed over part of the carriageway inadequate for two-lane traffic. This shall be done with the help of temporary traffic signals or flagmen kept positioned on opposite sides during all hours. For regulation of traffic, the flagmen shall be equipped with red and green flags and lanterns/lights.

On both sides, suitable regulatory / warnings signs as approved by the SE shall be installed for the guidance of road users. On each approach, at least two signs shall be put up, one close to the point where transition of carriageway begins and the other 120 m away. The signs shall be of design and of reflectory

type, if so directed by SE.

Upon completion of the works for which the temporary traffic arrangements or diversions have been made, the Contractor shall remove all temporary installations and signs and reinstate all affected roads and other structures or installations to the conditions that existed before the work started, as directed by the Engineer.

B. MAINTENANCE OF DIVERSIONS AND TRAFFIC CONTROL DEVICES

Signs, lights, barriers and other traffic control devices, as well as the riding surface of diversion shall be maintained in a satisfactory condition till such time they are required as directed by the SE. The temporary traveled way shall be kept free of dust by frequent applications of water, if necessary. The signages and devices required includes the following:

~ Barricading ~ Men at work ~ Keep Left ~ Go slow ~ Flag men ~ Narrow signs ~ Lantern(Amber Blinker) ~ Traffic control Lights ~ Cones

Safety jackets and helmets should be provided to all the workers/ Engineers working on the road. Fixed mobile solid barricades must be placed between the workmen and traffic or pedestrian and traffic. All the safety signs should be according to IRC: 67 and IRC: SP: 55: 2001 Examples of some good practice in traffic control during construction are shown in the figures below.

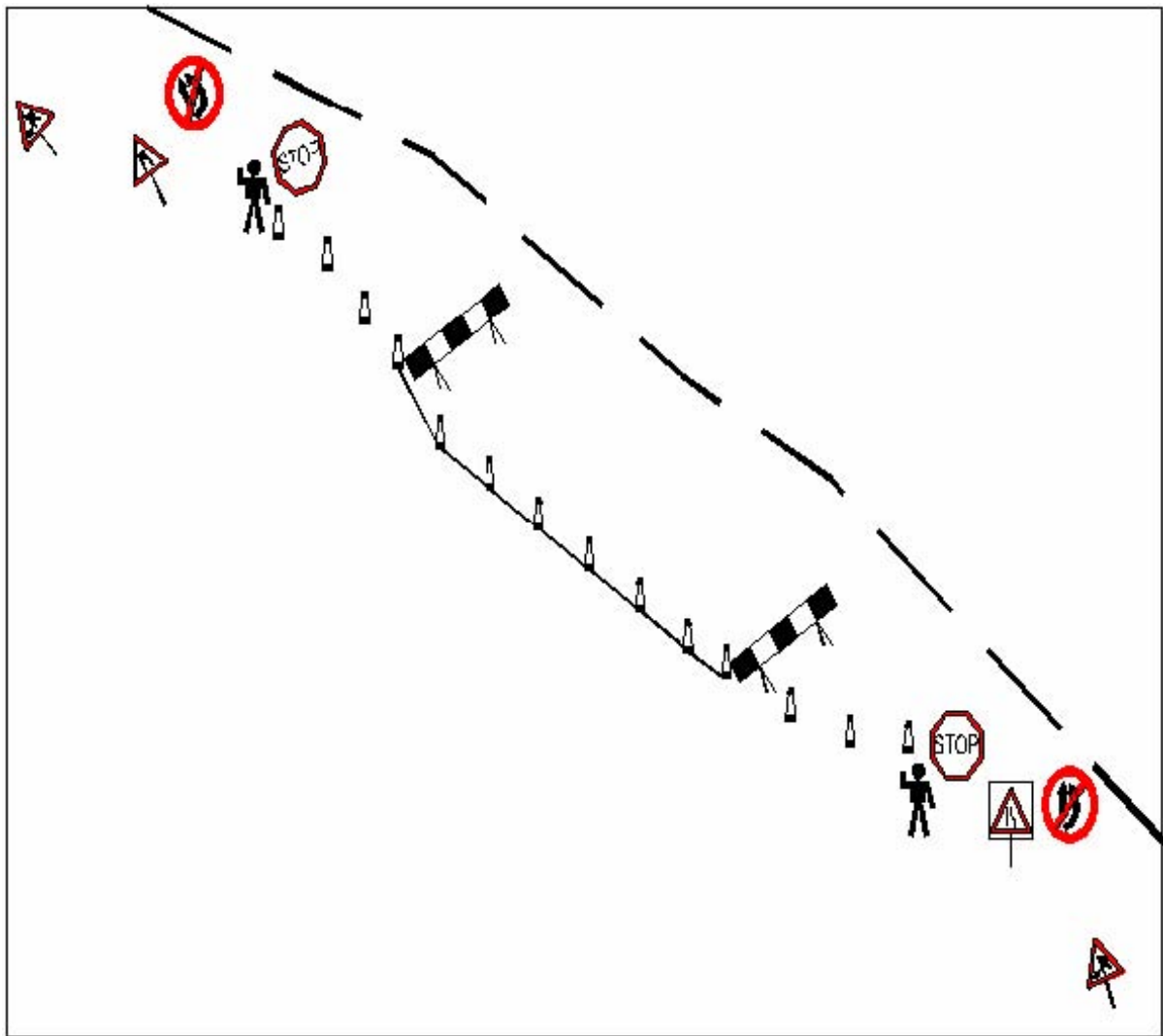

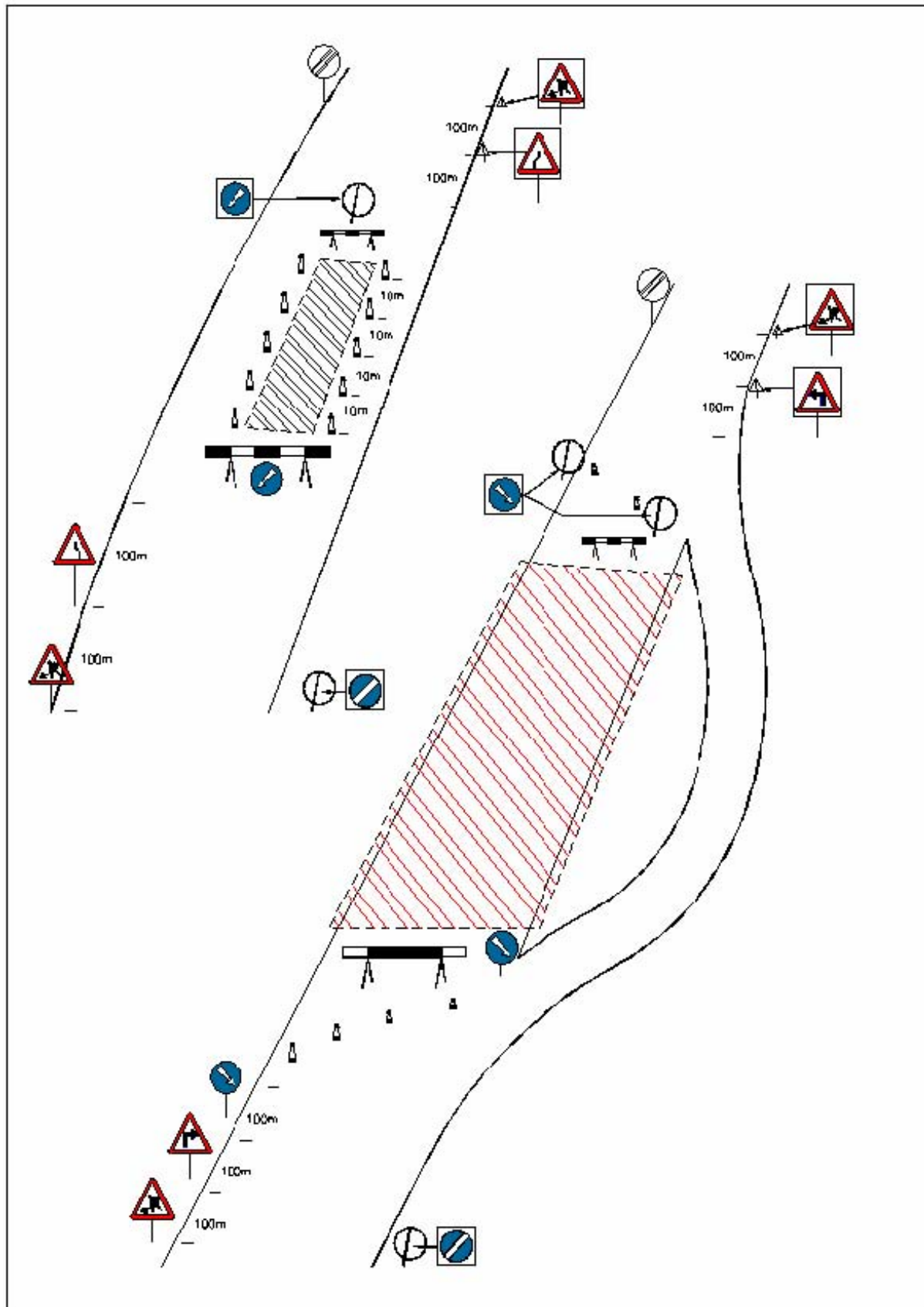

ANNEXURE 3.11: GUIDELINES FOR STORAGE, HANDLING, USE AND EMERGENCY RESPONSE FOR HAZARDOUS SUBSTANCES

A1. REFUELING/MAINTENANCE PROCEDURE

- There will be no storage of fuel, oil or fluids within 100m (or 50m) of the permanent water line.
- Prior to re-fueling or maintenance, drip pans and containment pans will be placed under the equipment. Absorbent blankets may also be required to be placed under the equipment and hoses where there is a possibility of spillage to occur.
- All used oils or fluids will be properly contained and transported to appropriately licensed (authorized) disposal facilities;
- Following re-fueling and maintenance, the absorbent blankets (if any) and spill pans will be picked up and the fuel truck or container moved outside of the 100m (or 50m) wide area.

Emergency Spill Procedure

Should a spill occur, either through spillage or equipment failure, the applicable emergency spill procedure outlined in sections A-2 to A-4 must be followed.

A2. SPILL PROCEDURE (INSIDE THE STREAM)

In the case of a spill, overflow or release fluid into the stream waterway (whether water is flowing during the spill or not), do what is practical and safely possible to control the situation, then get help.

- **Stop the flow**
 - Stop the release into the stream waterway
 - Shutdown equipment
 - Close valves and pumps
 - Plug hoses
- **Remove Ignition Sources**
 - Shut off vehicles and other engines
 - Do not allow tiger torches, vehicles, smoking or other sources of ignition near the area. Keep a fire extinguisher on hand but keep it a safe distance away from the potential ignition source (if a fire starts, the extinguisher must be easily accessible).
- **Contract the environmental Officer and initiate Emergency Response**
 - Notify the site supervisor and the Contractor's Environmental Officer as soon as possible
 - The Environmental Officer will review the situation and decide if Emergency Services like Fire Brigade are required
 - Appropriate parties to be notified of the spill are
 - The contractor's Project Manager
 - The Engineer through his designated Environmental Officer
 - The Client
 - Regulatory Agencies like Pollution Control Board, Municipal Authorities, as applicable.
 - Site Safety Officer

- **Cleanup and Disposal**
 - Emergency Services will be engaged for the containment, cleanup and disposal of contamination release into the environment
- **Reporting**
 - The contractor's Environmental Officer will document the event and submit reports to the EO/Engineer, the Client and appropriate regulatory agencies like the Pollution Control Board (s).
- **Procedure Review**
 - The Engineer will review the report, determine if changes are required to procedures and recommend implementation of all required changes....

A3. SPILL PROCEDURE (ON LAND)

In the case of a spill, overflow or release fluid onto land, do what is practical and safety possible to control the situation, and then get help.

- **Stop the flow**
 - Stop the release into the water body
 - Shut down equipment
 - Close valves and pumps
 - Plug hoses
- **Remove Ignition Sources**
 - Shut off vehicles and other engines
 - Do not allow tiger torches, vehicles, smoking or other sources of ignition near the area. Keep a fire extinguisher on hand but keep it a safe distance away from the potential ignition sources (if a fire starts the extinguisher must be easily accessible).
- **Contain the Spill**
 - Dike around the spill to contain the material
 - Spread absorbent or place a spill blanket on the spill
 - Enlist the help of personnel on site
 - Notify your supervisor as soon as possible
- **Notification**
 - Appropriate parties to be notified of the spill are:
 - The Contractor's Project Manager
 - The Engineer through his designated Environmental Officer
 - The Client
 - Regulatory Agencies like Pollution Control Board, Municipal Authorities, as applicable
 - Site Safety Coordinator
- **Cleanup and Disposal**
 - The Engineer's Environmental Officer will ensure that a proper cleanup and disposal method is determined.

- **Reporting**
 - The Contractor's Environmental Officer will document the event and submit reports to the Engineer, the Client and appropriate regulatory agencies like the Pollution Control Board (s).
- **Procedure Review**
 - The Engineer will review the report, determine if changes are required to procedures are recommend implementation of all required changes.

A4. SPILL PROCEDURE (WITHIN PONDS)

In the case of a spill, overflow or release fluid due to equipment or hose failure, do what is practical and safely possible to control the situation, and then get help

- **Stop the flow**
 - Stop the release
 - Shut down equipment
 - Close valves and pumps
 - Plug hoses
- **Remove Ignition Sources**
 - Shut off vehicles and other engines
 - Do not allow tiger torches, vehicles, smoking or other sources of ignition near the area. Keep a fire extinguisher on hand but keep it a safe distance away from the potential ignition sources (if a fire starts the extinguisher must be easily accessible).
- **Contain the Spill**
 - Stop any pumps that may be moving the water from the area where the spill occurred
 - Enlist the help of personnel on site
 - Notify your supervisor as soon as possible
- **Notification**
 - Appropriate parties to be notified or the spill are:
 - The Contractor's Project Manager
 - The Engineer through his designated Environmental Officer
 - The Client
 - Regulatory Agencies like Pollution Control Board, Municipal Authorities, as applicable
 - Site Safety Coordinator
- **Cleanup and Disposal**
 - The Engineer's Environmental Officer will ensure that a proper cleanup and disposal method is determined. Absorbent pads will soak up the spilled material. The pads will be contained and removed from site for disposal at a licensed (authorized) facility.
- **Reporting**
 - The Contractor's Environmental Officer will document the event and submit reports to the Engineer, the Client and appropriate regulatory agencies like the Pollution Control Board (s)
- **Procedure Review**

- The Engineer will review the report, determine if changes are required to procedures and recommend implementation of all required changes.

ANNEXURE 3.12: GUIDELINES FOR SITE CLEARANCE AND TREE FELLING

1. VEGETATION CLEARANCE

Vegetation clearance shall comprise uprooting of vegetation, grass, brushwood, shrubs, stumps, trees and saplings of girth upto 30 cm. measured at a height of one meter above the ground level. Where only clearance of grass is involved it shall be measured and paid for separately. The procedure/ steps involved for uprooting, skating and felling trees are described below.

1.1 Uprooting of Vegetation

- The roots of trees and saplings shall be removed to a depth of 60 cm. below ground level or 30 cm. below formation level or 15 cm below sub grade level, whichever is lower.
- All holes or hollows formed due to removal of roots shall be filled up with earth rammed and levelled.
- Trees, shrubs, poles, fences, signs, monuments, pipe lines, cables etc. within or adjacent to the area, which are not required to be disturbed during vegetation clearance shall be properly protected by the contractor at his own cost.

Staking and Disposal

- All useful materials obtained from clearing and grubbing operation shall be staked in the manner as directed by the Engineer.
- Trunks and branches of trees shall be cleared of limbs and tops stacked properly at the places indicated by the Engineer- in – charge. These materials shall be the property of the Government.
- All unserviceable materials are disposed off in such a manner that there is no livelihood of getting mixed up with the materials meant for construction.

Felling Trees

- *Marking of trees:* Trees, above 30 cm girth (measured at a height of one meter above ground level) to be cut, shall be approved by the Engineer-in-charge and then marked at the site.
- *Felling of trees:* Felling of trees shall include taking out roots up to 60 cm. below ground level or 30 cm. below formation level or 15 cm. below sub-grade level, whichever is lower.
- *Filling:* All excavations below general ground level arising out of removal of trees, stumps etc. shall be filled with suitable material in 20 cm. layers and compacted thoroughly so that the surface at these points conforms to the surrounding area.
- *Sizing:* The trunks and branches of trees shall be cleared of limbs and tops and cut into suitable pieces as directed by the Engineer-in-charge.
- *Staking:* The serviceable materials shall be staked in the manner as directed by the Environmental specialist of Supervision Consultants/Engineer-in-charge.
- *Disposal:* The material, which cannot be used or auctioned shall be removed from the area and disposed off as per the directions of the Engineer-in-charge. Unsuitable waste materials should not get mixed with construction material during disposal.

ANNEXURE3.13: GUIDELINES FOR SOIL EROSION AND SEDIMENTATION CONTROL

All materials shall meet commercial grade standards and shall be approved by the Engineer before being used in the work.

CONSTRUCTION STAGE

Prior to the start of the relevant construction, the Contractor shall submit to the Engineer for approval, his schedules for carrying out temporary and permanent erosion/sedimentation control works as are applicable for the items of clearing and grubbing, roadway and drainage excavation, embankment/sub-grade construction, bridges and other structures across water courses, pavement courses and shoulders. He shall also submit for approval his proposed method of erosion/sedimentation control on service road and borrow pits and his plan for disposal of waste materials. Work shall not be started until the erosion/sedimentation control schedules and methods of operations for the applicable construction have been approved by the Engineer.

The surface area of erodible earth material exposed by clearing and grubbing, excavation, borrow and fill operations shall be limited to the extent practicable. The Contractor may be directed to provide immediate control measures to prevent soil erosion and sedimentation that will adversely affect construction operations, damage adjacent properties, or cause contamination of nearby streams or other watercourses. Such work may involve the construction of temporary berms, dikes, sediment basins, slope drains and use of temporary mulches, fabrics, mats, seeding, or other control devices or methods as necessary to control erosion and sedimentation.

The Contractor shall be required to incorporate all permanent erosion and sedimentation control features into the project at the earliest practicable time as outlined in his accepted schedule to minimize the need for temporary erosion and sedimentation control measures.

Temporary erosion/sedimentation and pollution control measures will be used to control the phenomenon of erosion, sedimentation and pollution that may develop during normal construction practices, but may neither be foreseen during design stage nor associated with permanent control features on the Project.

Where erosion or sedimentation is likely to be a problem, clearing and grubbing operations should be so scheduled and performed that grading operations and permanent erosion or sedimentation control features can follow immediately thereafter if the project conditions permit; otherwise temporary erosion or sedimentation control measures may be required between successive construction stages. Under no conditions shall a large surface area of erodible earth material be exposed at one time by clearing and grubbing or excavation without prior approval of the EO/Engineer.

The Engineer may limit the area of excavation, borrow and embankment operations in progress, commensurate with the Contractor's capability and progress in keeping the finish grading, mulching, seeding and other such permanent erosion, sedimentation and pollution control measures, in accordance with the accepted schedule.

Temporary erosion is sometimes caused due to the Contractor's negligence, carelessness or failure to install permanent controls. Sedimentation and pollution control measures then become necessary as a part of the work as scheduled or ordered by the Engineer, and these shall be carried out at the Contractor's own expense. Temporary erosion, sedimentation and pollution control work required, which is not attributed to the Contractor's negligence, carelessness or failure to install permanent controls, will be performed as ordered by the EO/Engineer.

Temporary erosion, sedimentation and pollution control may include construction work outside the right of way where such work is necessary as a result of road construction such as borrow pit operations, service roads and equipment storage sites.

The temporary erosion, sedimentation and pollution control features installed by the Contractor shall be maintained by him till these are needed, unless otherwise agreed by the Engineer.

ANNEXURE 3.14: GUIDELINES FOR ARRANGEMENT WITH FOREST DEPARTMENT REGULATORY FRAMEWORK

- The TNRSP under the provisions of the Forest (Conservation) Act, 1980 will submit a diversion proposal in the prescribed format through the State Forest Department to the concerned Regional Office of the Ministry of Environment and Forests, of the Govt. of India. The Regional Office is the competent authority to dispose of such proposal irrespective of the area involved. In line with current directives for every tree cut at least ten trees have to be planted.
- Forest Department of the Government of TN after having identified the lands on the embankment and toes of the road will delineate the proposed area of compensatory afforestation on a suitable map. The Department of Forest will thereafter prepare an afforestation scheme providing therein the details of work schedule, the cost structure and proposed monitoring mechanism.

FUNDING MECHANISM

- The Ministry of Environment and Forests have constituted an authority known as **Compensatory Afforestation Fund Management and Planning Authority, CAMPA** for the purpose of management of money received from user agencies for compensatory afforestation. The TNRSP being the user agency in this project will be required to deposit the money as estimated by the State Forest Department to the CAMPA.
- CAMPA shall release funds to the State in predetermined instalments through the State Level Management Committee as per the Annual Plan of Operations drawn by the State Forest Department

MANAGEMENT AND MONITORING

- Strip plantations should be properly fenced to prevent damages by biotic interference.
- Wherever possible live- hedges may be provided; in such stretches live-hedges need be grown a year ahead of actual planting; such hedges may be reinforced by weaving with split bamboos.
- It may also be explored as to whether communities along the roads can be involved in protection and maintenance of such plantations through a mechanism of sharing of usufructs.

ANNEXURE 3.15: GUIDELINES FOR SELECTION OF TREE SPECIES

1. TREES TO BE AVOIDED:

S No.	Trees Name	Characteristics
1	Eucalyptus (all species), Millenglonia Hortensis, Eugenia jambolana, Albizzia lebbek, Cassia siamca and Ficus (all species).	All these tree species have very weak wood and consequently break easily in windstorm. After a heavy storm, roads become blocked and traffic is stopped for a considerable length of time. During a storm, these trees are threats to vehicles plying and pedestrians on the road. Besides the <i>eucalyptus</i> have a few other negative environmental impacts.
2	Acacia arabica, Acacia Modesta and Zizyphus Jujuba, etc	They are thorny trees to be avoided close to urban stretches. Their thorns are nuisances for the pneumatic tyres of small vehicles.
3	Ficus bengalensis	The <i>Ficus</i> species are of tap root system but flowing type (average depth of root system is 1.5m). Therefore, these, when mature, may overturn in strong-wind, storm, etc. Even the existing trees may be recommended for removal from safety points of view

2. TREES TO BE SELECTED:

S No.	Trees Name	Characteristics
1	Azardiracta indica (Neem)	The leaves, barks are used for medicinal purposes, and the seeds yield valuable oil. It can grow on alkaline usar soil
2	Maduca indica (Mahua)	The fruit is edible and seeds yields oil. It is also ornamental
3	Tamarindus indica (Imli)	A beautiful tree, which stands the dust of roads very well. Its fruit and timber are also valuable; suitable for dry area
4	Dalbergia sisoo (Shisham)	Yields excellent timber
5	Mangifera indica (Mango)	Yield valuable fruit
6	Safed siris	A quick growing beautiful tree. Because of the light yellow colour of the trunk, it reflects even weak light. This is an excellent roadside tree.

3. DUST RESISTANCE:

S No.	Species
1	Ficus bengalensis
2	Ficus religiosa
3	Magnifera indica
4	Anthocephalus
5	Lagerstroemia
6	Polyalthia longifolia
7	Tectona grandis
8	Terminalia arjuna
9	Bauhinea variegata

4. POLLUTION RESISTANCE:

S No.	Species
1	Albizzia lebbek
2	Cassia Fistula
3	Ficus glomerata
4	Anthocephalus indicus
5	Polyalthis longifolia
6	Eucalyptus sp.

ANNEXURE3.16: GUIDELINE FOR ENVIRONMENT FRIENDLY CONSTRUCTION METHODOLOGY

The contractor shall be deemed to have acquainted himself with the requirements of all the current statutes, ordinances, by-laws, rules and regulations or their instruments having the force of law including without limitation those relating to protection of the environment, health and safety, importation of labour, demolition of houses, protection of environment and procurement, transportation, storage and use of explosives, etc.

1. PROTECTION OF ENVIRONMENT

- (i) The contractor will take all necessary measures and precautions and ensure that the execution of the works and all associated operations on site or offsite are carried out in conformity with statutory and regulatory environmental requirements including those prescribed in EMP.
- (ii) The contractor will take all measures and precautions to avoid any nuisance or disturbance to inhabitants arising from the execution of works.
- (iii) All liquid waste products arising on the sites will be collected and disposed of at a location on or off the sites and in a manner that will not cause either nuisance or pollution.
- (iv) The contractor will at all times ensure that all existing water courses and drains within and adjacent to the site are kept safe and free from any contamination.
- (v) The contractor will submit details of his temporary drainage work system (including all surface channels, sediment traps, washing basins and discharge pits) to the Project Implementation Unit –TNRSP / Environment Officer for approval prior to commencing work on its construction.
- (vi) The contractor will arrange all the equipment in good condition to minimize dust, gaseous or other air-borne emissions and carry out the works in such a manner as to minimize adverse impact on air.
- (vii) Any vehicle with an open load-carrying area used for transporting potentially dust-producing material will have properly fitted side and tailboards. Materials having the potential to produce dust will not be loaded to a level higher than the side and tail boards and will be covered with a clean tarpaulin in good condition.
- (viii) The contractor will take all necessary measures to ensure that the operation of all mechanical equipment and condition processes on and off the site will not cause any unnecessary or excessive noise, taking into account applicable environmental requirements.
- (ix) The contractor will take necessary measures to maintain all plant and equipment in good condition.
- (x) Where the execution of the works requires temporary closure of road to traffic, the contractor will provide and maintain temporary traffic diversions subject to the approval of the EO/Engineer.
- (xi) Where the execution of the works requires single-lane operation on public road the contractor will provide and maintain all necessary barriers, warning signs and traffic control signals to the satisfaction of the EO/Engineer.
- (xii) Wherever traffic diversions, warning signs, traffic control signals, barriers and the like are required, the contractor will install them to the satisfaction of EO/Engineer prior to commencing the work, in that area.
- (xiii) Contractor will install asphalt plants and other machineries away from the populated areas as per laid down regulations.

- (xiv) Permit for felling of trees will be obtained from the forest department before the execution of any work.
- (xv) Trees and plants going to be uprooted will be duly compensated and maintained up to 3 years.
- (xvi) Mist sprays should be provided at appropriate places for preventing dust pollution during handling and stockpiling of stones and loose earth.
- (xvii) Over Burden (OB) waste dumps shall be sprayed with water, as they are the major source of air borne particulate matter.
- (xviii) OB waste dumps shall be reclaimed / afforested to bind the loose soil and to prevent soil erosion. The frequency of sprinkling should be fixed as per the seasonal requirement and in consultation with engineer.
- (xix) Regular water spraying on haulage roads during transportation of construction material by water sprinklers. The frequency of sprinkling should be fixed as per the seasonal requirements in consultation with engineer.
- (xx) Transfer point for transporting construction material shall be provided with appropriate hoods/ chutes to prevent dust emissions.
- (xxi) Dumping of construction material should be from an optimum height (preferably not too high), so as to reduce the dust blow.
- (xxii) Innovative approaches of using improvised machinery designs, with in-built mechanism to reduce sound emission.
- (xxiii) Procurement of drill loaders, dumpers and other equipment with noise proof system in operator's cabin.
- (xxiv) Confining the equipment with heavy noise emissions in soundproof cabins, so that noise is not transmitted to other areas.
- (xxv) Regular and proper maintenance of noise generating machinery including the transport vehicles to maintain noise levels.
- (xxvi) Provisions should be made for noise absorbing pads at foundations of vibrating equipments to reduce noise emissions.

2. QUARRY OPERATIONS

The Contractor shall obtain materials from quarries only after the consent of the Forest Department or other concerned authorities and in consultation with the EO/Engineer. The quarry operations shall be undertaken within the purview of the rules and regulations in force and instructions as mentioned in **Appendix 8.3: Guidelines for Quarry Management** and **Appendix 8.3: Guidelines for Borrow Area Management**.

3. PREVENTION OF WATER COURSES FROM SOIL EROSION AND SEDIMENTATION SILTATION

The Contractor shall apply following mitigation measures to prevent sedimentation and pollution of watercourses.

- To prevent increased siltation, if need be existing bridges maybe widened downstream side of the water body;
- Cement and coal ash should be stacked together, fenced by bricks or earth wall, and kept away from water, to prevent leachate formation and contamination of surface and ground water;
- During construction silt fencing could be used along the road at all surface water bodies which are directly impacted to prevent sediments from the construction site to enter into the watercourses.

4. POLLUTION FROM HOT-MIX PLANTS AND BATCHING PLANTS

Bituminous hot-mix plants and concrete batching plants shall be located sufficiently away from habitation, agricultural operations. The Contractor shall take every precaution to reduce the levels of noise, vibration, dust and emissions from his plants and shall be fully responsible for any claims for damages caused to the owners of property, fields and residents in the vicinity.

5. ARRANGEMENT FOR TRAFFIC DURING CONSTRUCTION

The Contractor shall at all times carry out work on the road in a manner creating least interference to the flow of traffic with the satisfactory execution. For all works involving improvements to the existing state highway, the Contractor shall, in accordance with the directives of the SE, provide and maintain, during execution of the work, a passage for traffic either along a part of the existing carriageway under improvement, or along a temporary diversion constructed close to the state highway. The Contractor shall take prior approval of the SE regarding traffic arrangements during construction.

6. TRAFFIC SAFETY AND CONTROL

- (i) Where subject to the approval of the Engineer the execution of the works requires temporary closure of road to traffic use, the Contractor shall provide and maintain temporary traffic diversions
- (ii) Where the execution of the works requires single-lane operation on public road, the Contractor shall provide and maintain all necessary barriers, warning signs and traffic control signals to the approval of the Engineer.
- (iii) With the exception of temporary traffic arrangements or diversions required within the first 4 weeks of the Contract, the Contractor shall submit details of his proposals to the Engineer for approval not less than 4 weeks prior to the temporary arrangement or diversion being required. Details of temporary arrangements or diversions for approval as soon as possible after the date of the Letter of Acceptance.
- (iv) The color, configuration, size and location of all traffic signs shall be in accordance with the code of practice for road sign. In the absence of any detail or for any missing details, the signs shall be provided as directed by the Supervising Engineer (SE).
- (v) The Contractor shall take all necessary measures for the safety of traffic during construction and provide, erect and maintain such barricades, including signs, marking, flags, lights and flagmen as may be required by the Engineer for the information and protection of traffic approaching or passing through the section of the road under improvement. Before taking up any construction, an agreed phased programme for the diversion of traffic or closer of traffic on the road shall be drawn up in consultation with the SE.
- (vi) At the points where traffic is to deviate from its normal path (whether on temporary diversion or part width of the carriageway) the lane width path for traffic shall be clearly marked with the aid of pavement markings, painted drums or a similar device to the directions of the SE. At night, the passage shall be delineated with lanterns or other suitable light source.
- (vii) One-way traffic operation shall be established whenever the traffic is to be passed over part of the carriageway inadequate for two-lane traffic. This shall be done with the help of temporary traffic signals or flagmen kept positioned on opposite sides during all hours. For regulation of traffic, the flagmen shall be equipped with red and green flags and lanterns / lights.
- (viii) On both sides, suitable regulatory / warnings signs as approved by the PIU-TNRSP shall be installed for the guidance of road users. On each approach, at least two signs shall be put up, one close to the point where transition of carriageway begins and the other 120 m away. The signs shall be of design and of reflectory type, if so directed by the Engineer.

- (ix) Upon completion of the works for which the temporary traffic arrangements or diversions have been made, the Contractor shall remove all temporary installations and signs and reinstate all affected roads and other structures or installations to the conditions that existed before the work started, as directed by the Engineer.

7. HEALTH AND SAFETY

The contractor shall take all measures and precautions necessary to ensure the health, safety and welfare of all persons entitled to be on the site. Such precautions shall include those that, in the opinion of the Engineer, are reasonable to prevent unauthorized entry upon the site and to protect members of the public from any activities under the control of the contractor. The contractor's responsibilities shall include but not be limited to:

- (i) The provision and maintenance of the Contractor's Equipment in a safe working condition and the adoption of methods of work that are safe and without risks to the health of any person entitled to be on the site.
- (ii) The execution of suitable arrangements for ensuring safety and absence of risks to health in connection with the use, handling, storage, transport and disposal of articles and substances,
- (iii) The provision of lighting, including standby facilities in the event of failure that, in the opinion of the Engineer, is adequate to ensure the safe execution of any works that are to be carried out at right.
- (iv) The provision of protective clothing and safety equipment, with such personnel and equipment and such information, instruction, training and supervision as are necessary to ensure the health and safety at work of all persons employed on or entering on the site in connection with the works, including the Engineer's supervisory staff, all in accordance with the laws.
- (v) Near towns, villages and all frequented places, trenches and foundation pits shall be securely fenced provided with proper caution signs and marked with lights at night to avoid accidents. Contractor shall take adequate protective measures to see that the excavation operations do not affect or damage adjoining structures.
- (vi) The contractor shall not use or generate any materials in the works, which are hazardous to the health of persons, animals or vegetation. Where it is necessary to use some substances, which can cause injury to the health of workers, the Contractor shall provide protective clothing or appliances to his workers.
- (vii) The contractor will take all measures necessary to safeguard the health; safety and welfare of all persons entitled to be on site and will ensure that works are carried out in a safe and efficient manner.
- (viii) The contractor will provide, and ensure the utilization of appropriate safety equipment for all workmen and staff employed directly or indirectly by the contractor. Such safety equipment will include but not be limited to the safety helmets, goggles and other eye protectors, hearing protectors, safety harnesses, and safety equipment for working over water, rescue equipment, fire extinguishers and first-aid equipment. The personnel working at vulnerable locations at site will wear safety helmets and strong footwear.
- (ix) The contractor will provide an adequate number of latrines and other sanitary arrangements at areas of the site where work is in progress and ensure that they are regularly cleaned and maintained in a hygienic condition.

8. FIRST AID

- (i) The provision and maintenance of suitably equipped and staffed first aid stations throughout the extent of the works to the satisfaction of the Engineer. The contractor shall allow in his prices and the responsible for the costs of all such site welfare arrangements and requirements.

- (ii) Injuries might occur during the construction period. It is therefore pertinent to provide first aid facilities for all the construction workers. At construction camps and at all workplaces first aid equipment and nursing staff must be provided. Since many of the workplaces may be far away from regular hospitals, an indoor health unit having one bed facility every 150 workers needs to be provided.
- (iii) Adequate transport facilities for moving the injured persons to the nearest hospital must also be provided in ready to move condition.
- (iv) The first-aid units apart from an adequate supply of sterilized dressing material should contain other necessary appliances as per the factory rules.

9. MAINTENANCE

- (i) All buildings, rooms and equipment and the grounds surrounding them shall be maintained in a clean and operable condition and be protected from rubbish accumulation.
- (ii) Each structure made available for occupancy shall be of sound construction, shall assure adequate protection against weather, and shall include essential facilities to permit maintenance in a clean and operable condition. Comfort and safety of occupants shall be provided for by adequate heating, lighting, ventilation or insulation when necessary to reduce excessive heat.
- (iii) Each structure made available for occupancy shall comply with the requirements of the Uniform Building Code. This shall not apply to tent camps.

10. MAINTENANCE OF DIVERSIONS AND TRAFFIC CONTROL DEVICES

Signs, lights, barriers and other traffic control devices, as well as the riding surface of diversion shall be maintained in a satisfactory condition till such time they are required as directed by the EO/Engineer. The temporary traveled way shall be kept free of dust by frequent applications of water, if necessary.

**ANNEXURE 3.17 REPORTING FORMAT FOR IDENTIFICATION OF
CONSTRUCTION CAMP SITE**

A	Project Details		Date of reporting:	
1.	Name of project stretch and link no.			
2.	Name and address of the Contractor			
3.	Contract date and duration			
4.	Status of completion of the project			
B	Site Details			
1.	Place Name		Landmark	
2.	Name of Panchayat / Municipality		Revenue Village	
3.	Taluk		District	
4.	Nearest Chainage (km) of the project road		location w.r.t. project road	LHS/ RHS
5.	Area of site		Current land use	
6.	Ownership of the land	Owned / leased	Survey no.	
7.	If leased / rented, name, address and contact details of owner			
8.	Distance from any major settlement or village			
9.	Distance from any major surface water course or body			
10.	Distance* from ecologically sensitive areas			
11.	Distance from the Project road			
12.	Width and type (paved or unpaved) of access road			
13.	No of trees with girth > 0.3m			
14.	No of trees to be cut			
15.	Is top soil conservation required (Yes/ No)			
List of enclosures:	(a) Location map			
	(b) Layout plan			
	(c) Photographs of the site			
	(d) List of machinery, equipments and vehicles to be used			
	(e) List of schools and hospitals with in 200 m distance from the boundary			

	of the camp	
C. Submission Details	Submitted by (Environment & Safety Engineer of Contractor)	Approved / Rejected by (Environmental Officer of CSC)
Signature & date		
Name		
Designation		
Remarks by CSC		

* All distances are to be measured from the boundary of the site. Note: Contractor has to fill and submit this format to the CSC upon identification of each construction camp site. Subsequently, the EO of CSC has to visit the site and approve / reject the site with reasons. The EO of CSC has to give a copy of this format to the contractor after his approval / rejection with remarks. On approval of a site, the Contractor has to prepare the Management and Redevelopment Plan for this site as per the Guidelines given in EMP and submit to CSC for approval.

**ANNEXURE 3.18 REPORTING FORMATS FOR IDENTIFICATION OF
LABOUR CAMP SITE**

A	Project Details		Date of reporting:	
1.	Name of project stretch and link no.			
2.	Name and address of the Contractor			
3.	Contract date and duration			
4.	Status of completion of the project			
B	Site Details			
1.	Place Name		Landmark	
2.	Name of Panchayat / Municipality		Revenue Village	
3.	Taluk		District	
4.	Nearest Chainage (km) of the project road		location w.r.t. project road	LHS/ RHS
5.	Area of site		Current land use	
6.	Ownership of the land	Owned / leased	Survey no.	
7.	If leased, name, address and contact details of owner			
8.	Distance* from any major settlement or village			
9.	Distance from any major surface water course or body			
10.	Distance from ecologically sensitive areas			
11.	Distance from the Project road			
12.	Width and type of access road			
13.	No of trees with girth > 0.3m			
14.	No of trees to be cut			
15.	Is top soil conservation required (Yes/ No)			
List of enclosure:	Location map			
	Layout Plan			
	Photographs of the site			
C. Submission Details	Submitted by (Environment & Safety Engineer of Contractor)		Approved / Rejected by (Environmental Officer of CSC)	

Signature & date		
Name		
Designation		
Remarks by CSC		

* All distances are to be measured from the boundary of the site. Note: Contractor has to fill and submit this format to the CSC upon identification of each Labour camp site. Subsequently, the EO of CSC has to visit the site and approve / reject the site with reasons. The EO of CSC has to give a copy of this format to the contractor after his approval / rejection with remarks. On approval of a site, the Contractor has to prepare the Management and Redevelopment Plan for this site as per the Guidelines given in EMP and submit to CSC for approval.

**ANNEXURE 3.19 REPORTING FORMAT FOR IDENTIFICATION OF QUARRY
AND STONE CRUSHER SITE**

A	Project Details		Date of reporting:	
1.	Name of project stretch and link no.			
2.	Name and address of the Contractor			
3.	Contract date and duration			
4.	Status of completion of the project			
B	Site Details			
1.	Place Name		Landmark	
2.	Name of Panchayat / Municipality		Revenue Village	
3.	Taluk		District	
4.	Nearest Chainage (km) of the project road		location w.r.t. project road	LHS/ RHS
5.	Area of site		Current land use	
6.	Ownership of the land	Owned / leased	Survey no.	
7.	If leased, name, address and contact details of owner			
8.	Type of material available and its quantity			
9.	Distance* of the site from:			
	(i) any major settlement or village			
	(ii) any major surface water course or body			
	(iii) any bridge, water supply system, infiltration well or pumping installation			
	(iv) any public road			
	(v) ecologically sensitive areas			
	(vi) nearest quarry / stone crusher			
10.	Distance from project road			
11.	Width and type of access road			
12.	No of trees with grid >0.3m			
13.	No of trees to be cut			
14.	Is top soil conservation required: Yes/ No			
15.	Place identified for top soil conservation			
List of enclosure:		(a) Location map		
		(b) Layout plan		

	(c) Photographs of the site	
	(d) List of schools and hospitals with in 200 m distance from the boundary of the site	
C. Submission Details	Submitted by (Environment & Safety Engineer of Contractor)	Approved / Rejected by (Environmental Officer of CSC)
Signature & date		
Name		
Designation		
Remarks by CSC		

* All distances are to be measured from the boundary of the site. Note: Contractor has to fill and submit this format to the CSC upon identification of each quarry and stone crusher site. Subsequently, the EO of CSC has to visit the site and approve / reject the site with reasons. The EO of CSC has to give a copy of this format to the contractor after his approval / rejection with remarks. On approval of a site, the Contractor has to prepare the Management and Redevelopment Plan for this site as per the Guidelines given in EMP and submit to CSC for approval.

ANNEXURE 3.20 REPORTING FORMAT FOR IDENTIFICATION OF BORROW AREAS

(To be Submitted by Contractor for taking consent for opening of Borrow area)

Construction Stage Report: Date ____ Month ____ Year ____

Site Layout of Borrow Area and Proposed Borrow Area Redevelopment Plan to be attached with format
Format to be submitted before target date as (decided by PIU) for establishing Borrow Areas

Borrow Area No. BA

Location of Borrow Area (Km ____ Package ____)

Sl. No	Item	Unit	Details	Remarks by SC/EO, if any
1	Details of Borrow Area			
a	Date of Borrow Area becoming operational dd/mm/yy			
b	Current Landuse			
c	Distance from Nearest Settlement	Km		
d	No of settlements within 200m of Haul Road	No.		
e	No of settlements within 500m of Borrow Area	No.		
f	Total Capacity	cum		
g	No of Trees with girth more than 0.3 m	No.		
h	Length of Haul Road	km		
i	Width of Haul road	m		
j	Type of Haul Road	metal/dirt		
k	Size of Borrow Area	sqkm		
l	Area of Borrow Area	km x km		
m	Quantity Available	cum		
n	Distance of Nearest Water Source	Type/Size/Capacity/Present Use/Ownership		
o	Quantity of top soil removed	cum		
p	Detail of storage of topsoil			
q	Daily/occasional use of the Borrow Area by the community, if any	-		
r	Probable reuse of Borrow pit-ask community	-		
s	Drainage channels/slope/characteristics of the area	-		
2	Enhancement Elements			
a	Quantity of top soil removed	sq.m		
b	Detail of storage of topsoil	sq.m		
c	Adjoining land use/Natural elements			
d	Nearby catchment for storing water			
e	Erosion Control Programme			
f	Preventive measures for			
i	Leaching			
ii	Mosquito Breeding			
iii	Water run-off/contamination			
iv	Any other environmental degradation			

Sl. No	Item	Unit	Details	Remarks by SC/EO, if any
3	Details of workforce			
a	Total No of Labourers	No.		
b	Total no of Male Workers	No.		
c	No of Male Workers below 18 years of age	No.		
d	Total No of Female Workers	No.		
e	No of Female workers below 18 years of age	No.		
4	Details of redevelopment, Plan to be enclosed			

Certified that the furnished information is correct the quality of work is as per good practice and all relevant information as required is attached

Project Engineer

(Supervision Consultant)

(Contractor)

Attach Photograph of Proposed Site, Location Map, and Agreement with land owner

REHABILITATION PLAN MEASURES	
LOCATION 1:	4:
LOCATION 2:	5:
LOCATION 3:	6:

REMARKS

SUBMITTED

CHECKED

APPROVED

SIGNATURE

SIGNATURE

SIGNATURE

.....

NAME

NAME

NAME

DESIGNATION

CONTRACTOR

CONSTRUCTION
SUPERVISION CONSULTANT

EXECUTIVE ENGINEER

ANNEXURE 3.21 REPORTING FORMAT FOR IDENTIFICATION OF DEBRIS DISPOSAL SITE

From _____ To _____

(Give chainage and nearest settlements from both ends)

Criteria on which information for each site is to be collected				Site 1	Site 2	Site 3	Site 4
Area covered (m ²)							
Total Material that can be dumped within the site (m ³)							
Depth to which dumping is feasible (m)							
Distance of nearest watercourse (m)							
Nearest Settlement (m)							
Date/s of Community Consultation/s							
Whether the community is agreeable to siting of dumping site (Y/N)							
Date of Permission from Village Council President(VCP)							
Proposed future use of the Site							

Selected Site (tick any one column only)

Certified that the above information is correct to the best of my knowledge and belief.

(Contractor)

Verified:

Date:

Recommendation on the suitability of the site

Signed:

Date:

Name & Designation:

Decision Taken (tick one):

Approved/Not Approved

Signed:

Date:

Name and Designation of Deciding Authority

Enclosure

(Tick as appropriate)

- 1 Maps of each location
- 2 Photographs
 - a Each dumping location
 - b Each community consultation
- 3 Photocopies of permissions from VCPs

Name and Designation of Verifier:

**ANNEXURE 3.22 REPORTING FORMAT FOR IDENTIFICATION OF
SOURCES OF WATER FOR CONSTRUCTION**

A	Project Details	Date of Reporting:	
1.	Name of project stretch and link no.		
2.	Name and address of the Contractor		
3.	Contract date and duration		
4.	Status of completion of the project		
B	Site Details		
1.	Place Name	Landmark	
2.	Name of Panchayat / Municipality	Revenue Village	
3.	Taluk	District	
4.	Nearest Chainage (km) of the project road	location w.r.t. project road	LHS/ RHS
5.	Type of water body (River / Canal / lake)		
6.	Existing users		
7.	Ownership of the water body		
8.	Authority responsible for giving permission		
9.	If private, name, address and contact details of owner		
10.	Distance from project road		
11.	Width and type of access road		
List of enclosure:	Location map		
	Photographs of the site		

C. Submission Details	Submitted by (Environment & Safety Engineer of Contractor)	Approved / Rejected by (Environmental Officer of CSC)
Signature & date		
Name		
Designation		
Remarks by CSC		

* All distances are to be measured from the boundary of the site. Ground water should not be used for construction.

Note: Contractor has to fill and submit this format to the CSC upon identification of each water source for construction. Subsequently, the EO of CSC has to visit the site and approve / reject the site with reasons. The EO of CSC has to give a copy of this format to the contractor after his approval / rejection with remarks.

ANNEXURE 3.23 FORMAT FOR REGISTER OF COMPLAINTS AND its REPORTING

A	Project Details		Information		
1.	Name of project stretch and road no				
2.	Name and address of the Contractor				
3.	Contract date and duration				
B	Details of Complaint Received		Site Name		
Sl. No.	Date of Complaint	Name and address of person with contact details	Complaint	Action taken with date	Signature of ESE of Contractor
1					
2					
3					

A register in this format shall be maintained at each site office of the contractor. This same format shall be used to compile and report the details of complaints received at all sites to the CSC along with the Monthly Report of the Contractor. The EO of CSC has to give instruction to the Contractor, if any further action has to be taken on any complaint.

ANNEXURE 3.24 FORMAT FOR REGISTER OF SITES OPENED AND CLOSED AND IT'S REPORTING

A		Project Details		Information							
1.	Name of project stretch and road no										
2.	Name and address of the Contractor										
3.	Contract date and duration										
B		Site Details									
Sl. No	Site opening Date	Type of Site*	Address of Site (Place name, Landmark, Revenue Village, Survey No., Panchayat, Taluk and District)	Name and Address of the	List of Clearances Required	Issue Date of each Clearance	Expiry Date of each Clearance	Site Closing Date	Redevelopment Status	Remarks	Signature of ESE of Contractor
1											
2											
3											

* Construction Camp / Labour camp / Quarry Area and Stone Crusher Unit / Borrow Area / Debris Disposal Site / Water Source. A site should be opened only after submitting the Management and Redevelopment Plan prepared as per the Guidelines given in EMP and got it approved by the EO of the CSC. A register in this format (preferably in A3 size paper) should be maintained by the contractor for each road. This same format shall be used to report the details of sites opened and closed to the CSC along with the Monthly Report of the Contractor. The EO of CSC has to give instruction to the contractor if any clearance is pending for any site.

ANNEXURE 3.25 CHECKLIST FOR MONITORING OF CONSTRUCTION CAMP MANAGEMENT

A		Project Details		Date of Monitoring:	
1.	Name of project stretch and road no.				
2.	Name and address of the Contractor				
3.	Contract date and duration				
4.	Status of completion of the project				
5.	Name of Construction Camp with sl. no. in Register of Sites				
B.		Monitoring Details			
Sl. No.	Environmental Management Measures	CSC's observation (Yes / No / Not Applicable)	Corrective Actions Proposed	Remarks	
1.	Whether concrete flooring and oil interceptors are provided for hot mix plant area and work shop, vehicle washing and fuel handling area?				
2.	Are all the first aid facilities provided in the camp?				
3.	Whether the plant is located in such a way that there are no residences, public institutions or hospital within a radius of 250 M from the centre of the plant?				

4.	Whether the vehicle movement in and out of the camp is in a controlled manner?			
5.	Does water in cross drainage channels block?			
6.	Whether all the plant and machineries are well maintained and regularly serviced?			
7.	Whether all the drains and channels are covered?			
8.	Whether a green belt is provided along the periphery of camp?			
9.	Whether water is stored for dust suppression in the camp?			
10.	Whether sanitation facilities are provided for male and female?			
11.	Whether separate garbage bins are provided to collect the garbage?			
12.	Whether septic tanks with soak pits are provided?			
13.	Whether the location of soak pit is in such a way that it does not pollute the ground water?			
14.	Whether a qualified safety officer is appointed for ensuring safety?			
15.	Whether noise barriers near sensitive receptors are provided?			

16.	Whether personal protective equipments are provided?			
17.	Whether warning sign boards are set up at the entrance gate for the public?			
18.	Whether all applicable clearances are obtained and valid till date?			
Signature of Environment and Safety Engineer (ESE) of the Contractor with date			Signature of Environmental Officer of the CSC with date	

Note: The Environmental Officer of the CSC has to use this format to monitor the implementation of Environmental Management Measures for each Construction Camp Quarterly. Corrective actions with specific timeframe should be proposed for each Environmental Management Measure, which is not implemented satisfactorily. A copy of the filled up format should be given to the ESE of the Contractor. CSC has to attach this format to the Quarterly Report to be submitted to PMU, with details of corrective action taken by the Contractor.

ANNEXURE 3.26 CHECKLIST FOR MONITORING OF LABOUR CAMP MANAGEMENT

A	Project Details		Date of Monitoring:	
1.	Name of project stretch and link no.			
2.	Name and address of the Contractor			
3.	Contract date and duration			
4.	Status of completion of the project			
5.	Name of Labour Camp with sl. no. in register of sites			
B	Monitoring Details			
Sl. No.	Environmental Management Measures	CSC's observation (Yes / No / Not Applicable)	Corrective Actions Proposed	Remarks
1.	Whether the camps are floored with concrete?			
2.	Are all the first aid facilities provided in the camp?			
3.	Whether the camp is located in such a way that there are no residences, public institutions or bio-sensitive area within a radius of 500 M from the camp?			
4.	Whether the vehicle movement in and out of the camp is in a controlled manner?			

5.	Whether LPG for cooking is provided?			
6.	Whether safe drinking water is provided?			
7.	Whether all the drains and channels are covered?			
8.	Whether a green belt is provided along the periphery of camp?			
9.	Whether day care centers are provided with in the camp?			
10.	Whether sanitation facilities are provided separately for male and female?			
11.	Whether separate garbage bins are provided to collect the garbage?			
12.	Whether septic tanks with soak pits are provided?			
13.	Whether the location of soak pit is in such a way that it does not pollute the ground water?			
14.	Whether a qualified safety officer is appointed for ensuring safety?			
15.	Whether proper fencing of the camp is done?			
16.	Whether the workers are well aware of cleanliness, hygiene, community livings, AIDS etc.?			

17.	Whether all applicable clearances are obtained and valid till date?			
Signature of Environment and Safety Engineer (ESE) of the Contractor with date			Signature of Environmental Officer of the CSC with date	

Note: The Environmental Officer of the CSC has to use this format to monitor the implementation of Environmental Management Measures for each Labour Camp Quarterly. Corrective actions with specific timeframe should be proposed for each Environmental Management Measure, which is not implemented satisfactorily. A copy of the filled up format should be given to the ESE of the Contractor. CSC has to attach this format to the Quarterly Report to be submitted to PMU, with details of corrective action taken by the Contractor.

ANNEXURE 3.27 CHECKLIST FOR MONITORING OF QUARRY AND STONE CRUSHER MANAGEMENT

A	Project Details		Date of Monitoring:	
1.	Name of project stretch and link no.			
2.	Name and address of the Contractor			
3.	Contract date and duration			
4.	Status of completion of the project			
5.	Name of Quarry & Crusher with sl. no. in register of sites			
B	Monitoring Details			
Sl. No.	Environmental Management Measures	CSC's observation (Yes / No / Not Applicable)	Corrective Actions Proposed	Remarks
1.	Whether the crusher units and/or other dust-producing units are housed in a building with a wall of minimum 23 cm thickness and with suitable roofing?			
2.	Whether quarry site is located at a distance of minimum 500 m. from human settlement, railway line, national highway, state highway, eco-sensitive area or district road*?			

3.	Whether stone quarry is located at a minimum distance of 50mts. from a water body?			
4.	Whether the vehicle movement in and out of the camp is in a controlled manner?			
5.	Whether a dust extraction with collection system is provided in the crusher unit and all transfer points?			
6.	Whether safe drinking water is provided for the workers?			
7.	Whether a dust extraction unit with collection system is provided in the crusher unit and all transfer points?			
8.	Whether a green belt is provided along the periphery of quarry?			
9.	Whether adequate systems with water spray and sprinkling is provided for dust suppression?			
10.	Whether the roads inside the crusher premises is tarred or concreted?			
11.	Whether separate garbage bins are provided to collect the garbage?			
12.	Whether the crusher, impactor and other connecting unit working time is restricted to day time (6 am to 6 pm)?			
13.	Whether dust sealing arrangement is provided in the impactor to avoid fugitive emission?			

14.	Whether the ambient sound level (Leq) at a distance of 1 m away from the boundary of the site is within 55 dB (A)?			
15.	Whether the occupier is conducting air monitoring on the suggested frequency?			
16.	Whether contour trenches are made to control soil erosion?			
17.	Whether workers are properly trained?			
18.	Whether sign boards of size 6' x 4' mentioning the project details and Contractor's details are placed for public?			
19.	Whether the stack height of the D.G set is adequate?			
20.	Whether arrangement made for avoiding fugitive emission from plants/ premises are adequate?			
21.	Whether natural drainage patterns are kept clear without not alteration or blockage?			
22.	Whether top soil conservation has been undertaken?			
23.	Whether all applicable clearances are obtained and valid till date?			
Signature of Environment and Safety Engineer (ESE) of the Contractor with date			Signature of Environmental Officer of the CSC with date	
<p>Note: The Environmental Officer of the CSC has to use this format to monitor the implementation of Environmental Management Measures for each Quarry & Crusher Quarterly. Corrective actions with specific timeframe should be proposed for each Environmental Management Measure, which is not implemented satisfactorily. A copy of the filled up format should be given to the ESE of the Contractor. CSC has to attach this format to the Quarterly</p>				

Report to be submitted to PMU, with details of corrective action taken by the Contractor.

⁴ If this is not possible, given the topographical features of the region, specify the reasons clearly.

ANNEXURE 3.28 CHECKLIST FOR MONITORING OF BORROW AREA MANAGEMENT

A	Project Details		Date of Monitoring:	
1.	Name of project stretch and link no.			
2.	Name and address of the Contractor			
3.	Contract date and duration			
4.	Status of completion of the project			
5.	Name of Borrow Area with sl. no. in register of sites			
B	Monitoring Details			
Sl. No.	Environmental Management Measures	CSC's observation (Yes / No / Not Applicable)	Corrective Actions Proposed	Remarks
1.	Whether the work at night is fully avoided?			
2.	Whether the approach road to the borrow area well maintained?			
3.	Whether the necessary traffic sign board is kept to control the traffic flow?			
4.	Whether any record is kept for the number of trees cut?			

5.	Whether a record on total quantity of earth evacuated is maintained?			
6.	Whether all waste materials from the borrow area is properly disposed?			
7.	Whether the relaying of the preserved top soil is carried out?			
8.	Whether required signages for the protection of the works or safety and convenience of public provided?			
9.	Whether effective measures are taken to control nuisance and disturbance arising from the execution work?			
10.	Whether the excavation is carried out in such a manner that the activity will not damage adjacent properties or cause contamination of nearby stream or other water bodies?			
11.	Whether the land is leveled after completion of work?			
12.	Whether the borrow pits are redeveloped?			
13.	Whether water logging is avoided?			
14.	Whether arrangements are made for regular sprinkling of water?			

15.	Whether all applicable clearances are obtained and valid till date?			
Signature of Environment and Safety Engineer (ESE) of the Contractor with date		Signature of Environmental Officer of the CSC with date		

Note: The Environmental Officer of the CSC has to use this format to monitor the implementation of Environmental Management Measures for each Borrow Area Quarterly. Corrective actions with specific timeframe should be proposed for each Environmental Management Measure, which is not implemented satisfactorily. A copy of the filled up format should be given to the ESE of the Contractor. CSC has to attach this format to the Quarterly Report to be submitted to PMU, with details of corrective action taken by the Contractor.

ANNEXURE 3.29 CHECKLIST FOR THE MONITORING OF DEBRIS DISPOSAL SITE MANAGEMENT

A	Project Details		Date of Monitoring:	
1.	Name of project stretch and link no.			
2.	Name and address of the Contractor			
3.	Contract date and duration			
4.	Status of completion of the project			
5.	Name of Debris Disposal Site with sl. no. in register of sites			
B	Monitoring Details			
Sl. No.	Environmental Management Measures	CSC's observation (Yes / No / Not Applicable)	Corrective Actions Proposed	Remarks
1.	Whether the construction operations are carrying out in such a manner that no waste material is dumped or disposed off in an unhealthy manner that causes any environmental hazard?			
2.	Whether the debris forming work close to the streams and water bodies are generally avoided during the monsoon period?			
3.	Whether the debris disposal site is at least 200 meter away from the surface water body?			

4.	Whether the debris disposal site is at least 500 meter away from the ecologically sensitive are, residential area or main road?			
5.	Whether the debris disposals along the water courses and close to the drainage channels are in such a manner that it do not cause any blockage to the flow of water?			
6.	Whether the bituminous waste is used as a surfacing material to the access roads to base camps, quarries, borrow area, temporary diversion, haulage routes etc.?			
7.	Whether the waste disposal details are submitted to the CSC in the prescribed format?			
8.	Whether the spoils from excavation of the river bed are disposing off at specified area suggested by the engineers?			
9.	Whether the debris generated due to dismantling of existing permanent structure is reused in the temporary diversion?			
10.	Whether the preserved topsoil is used for redevelopment of the area?			
11.	Whether green belt is developed?			

12.	Whether all applicable clearances are obtained and valid till date?			
Signature of Environment and Safety Engineer (ESE) of the Contractor with date			Signature of Environmental Officer of the CSC with date	

Note: The Environmental Officer of the CSC has to use this format to monitor the implementation of Environmental Management Measures for each Debris Disposal Site Quarterly. Corrective actions with specific timeframe should be proposed for each Environmental Management Measure, which is not implemented satisfactorily. A copy of the filled up format should be given to the ESE of the Contractor. CSC has to attach this format to the Quarterly Report to be submitted to PMU, with details of corrective action taken by the Contractor.

ANNEXURE 3.30 CHECK LIST FOR MONITORING OF REDEVELOPMENT OF CONSTRUCTION CAMP SITE

A	Project Details		Date of Monitoring:	
1.	Name of project stretch and road no.			
2.	Name and address of the Contractor			
3.	Contract date and duration			
4.	Status of completion of the project			
5.	Name of Construction Camp with sl. no. in register of sites			
B	Monitoring Details			
Sl. No.	Environmental Management Measures	CSC's observation (Yes / No / Not Applicable)	Corrective Actions Proposed	Remarks
1.	Are all the temporary structures cleared as per the list in the redevelopment plan?			
2.	Are all building debris, garbage, night soils and POL waste disposed off safely?			
3.	Are all disposal pits or trenches filled, disinfected and effectively sealed off?			
4.	Are the facilities that could be put to re-use maintained well?			
5.	Are all the spills within the camp site effectively disposed off from the site?			

6.	All the area within the camp site is leveled and spread over with stored top soil.			
7.	Has the residual top soil been utilized effectively?			
8.	Has the entire camp area been made clean and tidy without disturbing the adjacent lands?			
9.	Are the plantations / green belt along the boundary of the camp maintained well?			
10.	Are the 'before' and 'after' scenarios of the site documented through photographs and submitted to CSC?			
11.	Are the conditions mentioned by the owner in the agreement adhered to?			
12.	If not, mention the details of the conditions that are not adhered to and further steps to be taken.			
13.	Can 'works completion' certificate be issued to this site?			
Signature of Environment and Safety Engineer (ESE) of the Contractor with date			Signature of Environmental Officer of the CSC with date	

Note: The Environmental Officer of the CSC has to use this format to monitor the implementation of Environmental Management Measures for the redevelopment of each Construction Camp Site as and when it is closed. Corrective actions with specific timeframe should be proposed for each Environmental Management Measure, which is not implemented satisfactorily. A copy of the filled up format should be given to the ESE of the Contractor. CSC has to attach this format to the Quarterly Report to be submitted to PMU, with details of corrective action taken by the Contractor.

ANNEXURE 3.31 CHECK LIST FOR MONITORING OF REDEVELOPMENT OF LABOUR CAMP SITE

A	Project Details		Date of Monitoring:	
1.	Name of project stretch and link no.			
2.	Name and address of the Contractor			
3.	Contract date and duration			
4.	Status of completion of the project			
5.	Name of Labour Camp with sl. no. in register of sites			
B	Monitoring Details			
Sl. No.	Environmental Management Measures	CSC's observation (Yes / No / Not Applicable)	Corrective Actions Proposed	Remarks
1.	Are all the temporary structures cleared as per the list in the redevelopment plan?			
2.	Are all building debris, garbage, night soils and POL waste disposed off safely?			
3.	Are all disposal pits or trenches filled, disinfected and effectively sealed off?			
4.	Are the facilities that could be put to re-use maintained well?			
5.	Are all the spills within the camp site effectively disposed off from the site?			

6.	All the area within the camp site is leveled and spread over with stored top soil.			
7.	Has the residual top soil been utilized effectively?			
8.	Has the entire camp area been made clean and tidy without disturbing the adjacent lands?			
9.	Are the plantations / green belt along the boundary of the camp maintained well?			
10.	Are the 'before' and 'after' scenarios of the site documented through photographs and submitted to CSC?			
11	Are the conditions mentioned by the owner in the agreement adhered to?			
12.	If not, mention the details of the conditions that are not adhered to and further steps to be taken.			
13.	Can 'works completion' certificate be issued to this site?			
Signature of Environment and Safety Engineer (ESE) of the Contractor with date		Signature of Environmental Officer of the CSC with date		

Note: The Environmental Officer of the CSC has to use this format to monitor the implementation of Environmental Management Measures for the redevelopment of each Labour Camp Site as and when it is closed. Corrective actions with specific timeframe should be proposed for each Environmental Management Measure, which is not implemented satisfactorily. A copy of the filled up format should be given to the ESE of the Contractor. CSC has to attach this format to the Quarterly Report to be submitted to PMU, with details of corrective action taken by the Contractor.

ANNEXURE 3.32 CHECK LIST FOR MONITORING OF REDEVELOPMENT OF QUARRY AND STONE CRUSHER SITE

A	Project Details		Date of Monitoring:	
1.	Name of project stretch and road no.			
2.	Name and address of the Contractor			
3.	Contract date and duration			
4.	Status of completion of the project			
5.	Name of Quarry & Crusher with sl. no. in register of sites			
B	Monitoring Details			
Sl. No.	Environmental Management Measures	CSC's observation (Yes / No / Not Applicable)	Corrective Actions Proposed	Remarks
1.	Are all the temporary structures cleared as per the list in the redevelopment plan?			
2.	Are all debris, garbage, night soils and POL waste disposed off safely?			
3.	Are the facilities that could be put to re-use maintained well?			
4.	Has the conserved top soil been reused?			

5.	Are the improvement measures identified in the redevelopment plan implemented?			
6.	If not, mention the measures yet to be implemented.			
7.	Has the residual top soil been utilized effectively?			
8.	Has the entire area been made clean and tidy without disturbing the adjacent lands?			
9.	Are the plantations / green belt along the boundary of the camp maintained well?			
10.	Has additional tree plantation been undertaken as mentioned in the re-development plan?			
11.	Has erosion control measures and slope stabilization measures been undertaken?			
12.	Whether pits created by blasting are filled with overburden soil.			
13.	Has the local community been involved in the implementation of redevelopment plan?			
14.	Are the required photographs submitted to CSC?			
15.	Are the conditions mentioned by the owner in the agreement adhered to?			

16.	If not, mention the details of the conditions that are not adhered to and further steps to be taken.			
17.	Can 'works completion' certificate be issued to this site?			
Signature of Environment and Safety Engineer (ESE) of the Contractor with date			Signature of Environmental Officer of the CSC with date	

Note: The Environmental Officer of the CSC has to use this format to monitor the implementation of Environmental Management Measures for the redevelopment of each Quarry and Crusher Site as and when it is closed. Corrective actions with specific timeframe should be proposed for each Environmental Management Measure, which is not implemented satisfactorily. A copy of the filled up format should be given to the ESE of the Contractor. CSC has to attach this format to the Quarterly Report to be submitted to PMU, with details of corrective action taken by the Contractor.

ANNEXURE 3.33 CHECK LIST FOR MONITORING OF REDEVELOPMENT OF BORROW AREAS

A	Project Details		Date of Monitoring:	
1.	Name of project stretch and link no.			
2.	Name and address of the Contractor			
3.	Contract date and duration			
4.	Status of completion of the project			
5.	Name of Borrow Area with sl. no. in register of sites			
B	Monitoring Details			
Sl. No.	Environmental Management Measures	CSC's observation (Yes / No / Not Applicable)	Corrective Actions Proposed	Remarks
1.	Has slope stabilization been undertaken along the edges (if there is a level difference)?			
2.	Is all the waste material raised from the borrow area disposed of properly?			
3.	Has the preserved top soil been used in redevelopment of site?			
4.	Has the borrow areas been re-vegetated properly?			

5.	Are the cross drainage system and the flood water drains managed properly to avoid occurrence of flooding?			
6.	Are the borrow area pits re-developed?			
7.	Is the leveling of depression after filling-in of wastes undertaken?			
8.	Selection of Species as per OSRP Project Guidelines for plantation.			
9.	Has bund creation and temporary fencing been undertaken?			
10.	Ponds including creation of new ones and enhancing capacity of existing ones (for irrigation; pisciculture and general uses by people and/or cattle)			
Signature of Environment and Safety Engineer (ESE) of the Contractor with date			Signature of Environmental Officer of the CSC with date	

Note: The Environmental Officer of the CSC has to use this format to monitor the implementation of Environmental Management Measures for the redevelopment of each Borrow Area as and when it is closed. Corrective actions with specific timeframe should be proposed for each Environmental Management Measure, which is not implemented satisfactorily. A copy of the filled up format should be given to the ESE of the Contractor. CSC has to attach this format to the Quarterly Report to be submitted to PMU, with details of corrective action taken by the Contractor.

ANNEXURE 3.34 CHECK LIST FOR MONITORING OF REDEVELOPMENT OF DEBRIS DISPOSAL SITE

A	Project Details		Date of Monitoring:	
1.	Name of project stretch and road no.			
2.	Name and address of the Contractor			
3.	Contract date and duration			
4.	Status of completion of the project			
5.	Name of Borrow Area with sl. no. in register of sites			
B	Monitoring Details			
Sl. No.	Environmental Management Measures	CSC's observation (Yes / No / Not Applicable)	Corrective Actions Proposed	Remarks
1.	Rehabilitation of the dump site by planting local shrubs and other plant species.			
2.	Conversion of debris site into farm land, playground, parking area, block plantation area etc.			
3.	Maintenance of the hydrological flow in the area.			
Signature of Environment and Safety Engineer (ESE) of the Contractor with date			Signature of Environmental Officer of the CSC with date	

Note: The Environmental Officer of the CSC has to use this format to monitor the implementation of Environmental Management Measures for the redevelopment of each Debris Disposal Site as and when it is closed. Corrective actions with specific timeframe should be proposed for each Environmental Management Measure, which is not implemented satisfactorily. A copy of the filled up format should be given to the ESE of the Contractor. CSC has to attach this format to the Quarterly Report to be submitted to PMU, with details of corrective action taken by the Contractor.

ANNEXURE 3.35 REPORTING FORMAT FOR WORK FORCE MANAGEMENT

A	Project Details			Date of Reporting:	
1.	Name of project stretch and link no.				
2.	Name and address of the Contractor				
3.	Contract date and duration				
4.	Status of completion of the project				
5.	Name of Work Site with sl. no. in register of sites				
B.	Status of work force				
SI. No.	Category of work force	Work force in the Previous Month (No.)	Work force added in the reporting month (No.)	Work Force left in the reporting month (No.)	Total work force in the reporting month (No.)
1.	Unskilled Labourers				
2.	Skilled labourers				
3.	Supervisors				
4.	Engineers				

5.	Office Staff										
	Sub Total										
	Grand Total										
C.	Categorization of work force										
SI. No.	Category of work force	Male		Female		Employment Status		Residential Status		Accommodation Status	
		< 18 yrs.	> 18 yrs.	< 18 yrs.	> 18 yrs.	Regular	Temporary	Migrant	Local	Staying in Labour Camp / Quarters	Others
1.	Unskilled Labourers										
2.	Skilled labourers										
3.	Supervisors										
4.	Engineers										
5.	Office Staff										
	Sub Total										
	Grand Total										

D. Details of non-working migrated people, living in the Labour Camps / Staff Quarters as part of work force family									
No. of children (0-6 yrs.)			No. of children (7-18 yrs.)			No. of adults			Grand Total
Male	Female	Total	Male	Female	Total	Male	Female	Total	
E. Submission Details									
		Submitted by (Environmental & Safety Engineer of Contractor)				Approved by (Environmental Officer of CSC)			
Signature & date									
Name									
Designation									
Remarks by CSC									

Note: Contractor has to fill and submit this format to the CSC along with the Monthly Report. In addition to that, the Contractor has to maintain the database of work force in the form of a register. An attendance register for the work force should also be maintained by the Contractor. Contractor has to report the details of migrant work force to the nearest police station. The CSC has to visit the sites and verify the details. The EO of CSC has to give back a copy of this format to the contractor after his approval with remarks.

ANNEXURE 3.36 REPORTING FORMAT FOR OCCUPATIONAL HEALTH AND SAFETY MEASURES

A	Project Details		Date of Reporting:
1.	Name of project stretch and link no.		
2.	Name and address of the Contractor		
3.	Contract date and duration		
4.	Status of completion of the project		
B	Implementation Status of Health and Safety Measures		
Sl. No.	Health and Safety Measures	Implementation Status (Yes / No)	Remarks
1	Appointment of qualified Environment and Safety Engineer		
2	Approval for Construction Safety Management Plan by the Engineer.		
3	Provision for flags and warning lights for potential hazards		
4	Provision of adequate staging, form work and access (ladders with handrail) for works at a height of more than 3.0 m		
5	Provision of adequate shoring / bracing / barricading / lighting for all deep excavations of more than 3.0 m depth.		

6	Provision for sufficient lighting especially for night time work		
7	Construction Workers safety - Provision of personnel protective equipments		
	A. Helmets		
	B. Safety Shoe		
	C. Dust masks		
	D. Hand Gloves		
	E. Safety Belts		
	F. Reflective Jackets		
	G. Earplugs for labour		
8	Workers engaged in welding work shall be provided with welder protective shields		
9	All vehicles are provided with reverse horns.		
10	All scaffolds, ladders and other safety devices shall be maintained in as safe and sound condition		
11	Regular health checkup for labour/ Contractor's personnel		
12	Ensuring the sanitary conditions and all waste disposal procedures & methods in the camps.		

13	Provision for insurance coverage to the workers			
C.	Submission Details			
	Submitted by (Environment & Safety Engineer of Contractor)		Approved by (Environmental Officer of CSC)	
Signature & date				
Name				
Designation				
Remarks by CSC				
<p>Note: Contractor has to fill and submit this format to the CSC along with the Monthly Report. The CSC has to visit the sites and verify the details. Further mitigation measures, if required, can be suggested by the CSC. The EO of CSC has to give back a copy of this format to the contractor after his approval with remarks.</p>				

ANNEXURE 3.37 REPORTING FORMAT FOR TOP SOIL CONSERVATION

A	Project Details		Date of Reporting:
1.	Name of project stretch and road no.		
2.	Name and address of the Contractor		
3.	Contract date and duration		
4.	Status of completion of the project		
5.	Name of Site with sl. no. in register of sites		
B	Top Soil Conservation Details		
Sl. No.	List of Activities	Status (Yes / No)	Remarks
1.	Whether the location was pre-identified?		
2.	Whether the slope is <1:2?		
3.	Whether height is less than 2 m?		
4.	Whether edges of pile are protected by silt fencing?		
5.	Whether multiple handling is kept to a minimum		
6.	Whether measures are taken to prevent the loss during rains.		
7.	Whether any other measure is provided? If yes, What is it?		

C.	Submission Details	
	Submitted by (Environment & Safety Engineer of Contractor)	Approved by (Environmental Officer of CSC)
Signature & date		
Name		
Designation		
Remarks by CSC		

Note: Contractor has to fill and submit this format to the CSC along with the Monthly Report. This format is to be filled for each site, after opening the site. The CSC has to visit the sites and verify the details. Further mitigation measures, if required, can be suggested by the CSC. The EO of CSC has to give back a copy of this format to the contractor after his approval with remarks.

ANNEXURE 3.38 REPORTING FORMAT FOR WATER SPRINKLING FOR DUST SUPPRESSION

A		Project Details		Month and Year of reporting:																														
1.	Name of project stretch and road no.																																	
2.	Name and address of the Contractor																																	
3.	Contract date and duration																																	
4.	Status of completion of the project																																	
5.	Location of water sprinkling																																	
B		Water Sprinkling Details																																
Particulars	Days																																	
	1	2	3	4	5	6	7	8	9	10	11	12	13	14	15	16	17	18	19	20	21	22	23	24	25	26	27	28	29	30	31			
No. of trips per day																																		
Quantity of Water Sprinkled (KLD)																																		
If not sprinkled, reason for the same																																		

C. Submission Details		
	Submitted by (Environment & Safety Engineer of Contractor)	Approved by (Environmental Officer of CSC)
Signature & date		
Name		
Designation		
Remarks by CSC		

Note: Contractor has to fill this format for each construction site (preferably in A3 size paper) and submit to the CSC along with the Monthly Report. The CSC has to visit the sites and verify the details. Additional water sprinkling, if required, can be suggested by the CSC. The EO of CSC has to give back a copy of this format to the contractor after his approval with remarks.

ANNEXURE 3.39 REPORTING FORMAT FOR ROAD SAFETY MEASURES DURING CONSTRUCTION

A	Project Details		Date of Reporting:
1.	Name of project stretch and link no.		
2.	Name and address of the Contractor		
3.	Contract date and duration		
4.	Status of completion of the project		
B	Details of Safety Measures		
S.No	Safety Measures	Compliance Status (Yes / No)	Remarks
a.	General		
1	A qualified Environment and Safety Engineer should be appointed		
2	A Traffic Management Plan should be prepared in accordance with IRC: SP: 55-2001 and got approved by the Engineer		
3	Maintenance of existing road stretches handed over to the Contractor should be carried out		
b.	Details of Construction Zone		
1	Length of transition sub zone should be min 50 m for a speed of 50km/hr		
2	Length of work sub zone in urban stretch should be <2 km		
3	Length of work sub zone in rural stretch should be 5-10 km		

C	Signages in construction zones		
1	Sign saying ‘Men at Work’ should be kept 1 km ahead of Transition sub zone		
2	Supplementary sign saying Diversion 1 km should be provided		
3	Sign saying ‘Road Closed ahead’ should be provided		
4	Compulsory Turn Right/Left sign should be provided		
5	Detour sign should be placed		
6	Sharp Deviation sign should be placed at end of advance warning sub zone		
7	Signage should be provided in Transition Sub Work Zone		
8	Signage saying ‘Keep Right/Left should be provided		
9	Signage should be placed in work sub zone		
10	Hazard Marker should be placed where railing for CD structure on diversion starts		
11	Barricade should be provided on either side of work sub zone		
12	Flag persons should be provided for traffic control		
13	Flags and warning lights should be provided at Construction zones		

14	Metal drum /empty bitumen drum delineator, painted in circumferential strips of alternate black and white 100mm wide 2 coats fitted with reflectors 3 Nos of 7.5cm diameter or Barricades/caution tapes should be provided in construction zones		
15	Plastic crash barriers should be provided		
16	Demarcations (fencing, guarding and watching) should be provided at bridge / culvert construction sites		
17	Arrangements should be made for controlled access and entry to Construction zones		
18	Regular Inspection of Work Zone Traffic Control Devices should be carried out by authorized contractor personnel		
19	All vehicles should be provided with reverse horns		
20	Speed of construction vehicles should be controlled through road safety training of drivers		
d.	Signage in Termination sub zone		
1	Sign for indication of end of work zone should be placed 120m from end of termination sub zone		
e.	Road Delineators		
1	Roadway indicators should be provided		
2	Hazard markers should be provided		

3	Object markers should be provided		
C.	Submission Details		
	Submitted by (Environment & Safety Engineer of Contractor)		Approved by (Environmental Officer of CSC)
Signature & date			
Name			
Designation			
Remarks by CSC			

Note: Contractor has to fill this format and submit to the CSC along with the Monthly Report. The CSC has to visit the sites and verify the details. Additional safety measures, if required, can be suggested by the CSC. The EO of CSC has to give back a copy of this format to the contractor after his approval with remarks.

ANNEXURE 3.40 FORMAT FOR REGISTER OF ACCIDENTS AND IT'S REPORTING

A	Project Details	Date of Reporting:		
1.	Name of project stretch and road no.			
2.	Name and address of the Contractor			
3.	Contract date and duration			
4.	Status of completion of the project			
B	Details of Accident and People Involved in Accident			
	Name of site where accident happened			
	Name and address of people involved in the accident			
	Whether Contractor's personnel or General public			
	Details of Injury			
	Details of treatment given			
	Details of compensation given			
C	Type of Accident (√)			
	Fall of person from a height			Explosion
	Slip, trip or fall on same level			Fire
	Struck against fixed objects			Contact with hot or corrosive substance
	Struck by flying or falling objects			Contact with poisonous gas or toxic substances.
	Struck by moving objects			Contact with poisonous gas or toxic substances
	Struck / caught by cable			Hand tool accident
	Stepping on nail etc.			Vehicle / Mobile plant accident
	Handling without machinery			Machinery operation accident
	Crushing / burying			Other (please specify)
	Drowning or asphyxiation			

D	Agent Involved in Accident (√)			
	Machinery			Stair edge
	Portable power appliance			Excavation / underground working
	Vehicle or associated equipment /machinery			Ladder
	Material being handled, used or stored			Scaffolding /gondola
	Gas, vapor, dust, fume or oxygen			Construction formwork, shuttering and false work.
	Hand tools			Electricity supply cable, wiring switchboard and associated equipment
	Floor edge			Nail, sllnter or chipping
	Floor opening			Other (Please specify)
	Left shaft			
E	Unsafe Action Relevant to the Accident (√)			
	Operating without authority			Failure to use proper footwear
	Failure to secure objects			Failure to use eye protector
	Making safety devices inoperative			Failure to use respirator
	Working on moving or dangerous equipment			Failure to use proper clothing
	Using un-safety equipment			Failure to use warn others or given proper signals
	Adopting unsafe position or posture			Horseplay
	Operating or working at unsafe speed			No unsafe action
	Unsafe loading, Placing, mixing et			Others (please specify)
	Failure to use helmet			
F	Lack of Safety Measures Relevant to the Accident (√)			
	No protective gear			Unsafe layout of job, traffic etc.
	Defective protective gear			Unsafe process of job methods
	Improper dress / footwear			Poor housekeeping
	Improper guarding			Lack of warning system
	Improper ventilation			Defective tool, machinery or materials

	Improper illumination			No unsafe condition
	Improper procedure			Others (please specify)
G	Personal Factor Relevant to the Accident (√)			
	Incorrect attitude /motive			No unsafe personal factor.
	Unsafe act by another person			Other (please specify)
H	Details of Corrective and Preventive action taken			
1				
2				
3				
4				
I	Submission Details			
	Submitted by (Environment & Safety Engineer of Contractor)		Approved by (Environmental Officer of CSC)	
Signature & date				
Name				
Designation				
Remarks by CSC				

Note: Contractor has to fill this format as and when an accident happens and submit to the CSC along with the Monthly Report. The CSC has to visit the sites and verify the details. Additional safety measures, if required, can be suggested by the CSC. The EO of CSC has to give back a copy of this format to the contractor after his approval with remarks.

ANNEXURE 3.41 REPORTING FORMAT FOR ENVIRONMENTAL QUALITY MONITORING

A		Project Details		Date of Reporting:		
1.	Name of project stretch and road no.					
2.	Name and address of the Contractor					
3.	Contract date and duration					
4.	Status of completion of the project					
B						
Environmental Monitoring Details						
Sl. No	Details of Monitoring Location	Period of Monitoring	Details of values exceeding the relevant standards	Reasons for pollution	Details of Corrective actions taken	Remarks
a.	Air Monitoring					
1.						
2.						
3.						

b.	Water Monitoring					
1.						
2.						
3.						
c.	Noise Monitoring*					
1.						
2.						
3.						
C	Submission Details					

	Submitted by (Environment & Safety Engineer of Contractor)	Approved by (Environmental Officer of CSC)
Signature & date		
Name		
Designation		
Remarks by CSC		

** Noise monitoring along the road will be done by the CSC, using the Noise Meter of PMU. The CSC has to give the monitoring results to the Contractor for corrective actions, if any, required and including in this report.*

Note: The Contractor has to conduct Environmental Monitoring through a NABL approved Laboratory as per the Environmental Monitoring Plan given in the EMP, fill this format and submit to the CSC along with the Monthly Report, if monitoring was due in that month. A copy of the monitoring report given by the Laboratory has to be attached to this format. The CSC has to visit the sites and verify the details. Additional mitigation measures, if required, can be suggested by the CSC. The EO of CSC has to give back a copy of this format to the contractor after his approval with remarks.

ANNEXURE 3.42 REPORTING FORMAT FOR ENHANCEMENT AND MITIGATION OF CULTURAL PROPERTIES

A	Project Details		Date of reporting:
1.	Name of project stretch and link no.		
2.	Name and address of the Contractor		
3.	Contract date and duration		
4.	Status of completion of the project		
B	Details of Enhancement and Mitigation of Cultural Properties		
Sl. No.	Location with chainage	% work completed	Remarks and reasons for delay, if any.
C	Submission Details		
	Submitted by (Environment & Safety Engineer of Contractor)	Approved by (Environmental Officer of CSC)	
Signature & date			
Name			
Designation			
Remarks by CSC			

Note: The Contractor has to fill the details of cultural properties for which enhancement and mitigation measures were carried out during the reporting month in this format and submit to the CSC along with the Monthly Report. Overall progress in this activity for the entire project road is to be included in the Monthly Report. The CSC has to visit the sites and verify the details. Additional mitigation measures, if required, can be suggested by the CSC. The EO of CSC has to give back a copy of this format to the contractor after his approval with remarks.

**ANNEXURE 3.43 REPORTING FORMAT FOR NOISE BARRIER
CONSTRUCTION**

A	Project Details		Date of reporting:
1.	Name of project stretch and road no.		
2.	Name and address of the Contractor		
3.	Contract date and duration		
4.	Status of completion of the project		
B	Details of Noise Barriers Constructed		
S. No .	Location with chainage	% work completed	Remarks and reasons for delay, if any.
C	Submission Details		
	Submitted by (Environment & Safety Engineer of Contractor)		Approved by (Environmental Officer of CSC)
Signature & date			
Name			
Designation			
Remarks by CSC			

Note: The Contractor has to fill the details of Noise Barriers constructed during the reporting month in this format and submit to the CSC along with the Monthly Report. Overall progress in this activity for the entire project road is to be included in the Monthly Report. The CSC has to visit the sites and verify the details. The EO of CSC has to give back a copy of this format to the contractor after his approval with remarks.

**ANNEXURE 3.44 REPORTING FORMAT FOR ENHANCEMENT MEASURES
OTHER THAN CULTURAL PROPERTIES**

A	Project Details		Date of reporting:
1.	Name of project stretch and road no.		
2.	Name and address of the Contractor		
3.	Contract date and duration		
4.	Status of completion of the project		
B	Details of Enhancement Measures		
Sl. No.	Location with chainage	% work completed	Remarks and reasons for delay, if any.
a	Raising embankment height		
b	Public water sources		
c	Bus stops and bus bays		
d	Water bodies		

e	Auto / Jeep / Taxi stands		
f	Sign Boards		
g	Oxbow land (Type C) development		
h	Any other measures		
C	Submission Details		
	Submitted by (Environment & Safety Engineer of Contractor)		Approved by (Environmental Officer of CSC)
Signature & date			
Name			
Designation			
Remarks by CSC			

Note: The Contractor has to fill the details of enhancement measures carried out for amenities / facilities other than cultural properties during the reporting month in this format and submit to the CSC along with the Monthly Report. Overall progress in this activity for the entire project road is to be included in the Monthly Report. The CSC has to visit the sites and verify the details. Additional mitigation measures, if required, can be suggested by the CSC. The EO of CSC has to give back a copy of this format to the contractor after his approval with remarks.

ANNEXURE 3.45 REPORTING FORMAT FOR TREE PLANTATION

A		Project Details		Date of reporting:
1.	Name of project stretch and road no.			
2.	Name and address of the Contractor			
3.	Contract date and duration			
4.	Status of completion of the project			
B				
Details of Trees Planted				
Sl. No.	Location with chainage	No. of Trees to be Planted	% work completed	Remarks and reasons for delay, if any
C				
Submission Details				
		Submitted by (Environment & Safety Engineer of Contractor)		Approved by (Environmental Officer of CSC)
Signature & date				
Name				
Designation				
Remarks by CSC				

Note: The Contractor has to fill the details of Trees planted during the reporting month in this format and submit to the CSC along with the Monthly Report. Overall progress in this activity for the entire project road is to be included in the Monthly Report. The CSC has to visit the sites and verify the details. The EO of CSC has to give back a copy of this format to the contractor after his approval with remarks.

ANNEXURE 3.46 REPORTING FORMAT FOR MONTHLY REPORT FROM CONTRACTOR TO CSC

A	Project Details			Period of Reporting:					
1.	Name of project stretch and road no.								
2.	Name and address of the Contractor								
3.	Contract date and duration								
4.	Status of completion of the project								
B	Physical Progress Report								
SI. No	Enhancement Measure	Physical target (Nos.)	Units carried over from previous month	Units started in reporting month	Units completed in reporting month	Units carried over to next month	Cumulative units completed till end of reporting month	% target completed	Remarks / reasons for delay
			(a)	(b)	(c)	(d=a+b-c)			
1.	Noise barrier								
2.	Hand pumps								
3.	Bus Shelter								
4.	Sign Boards								
5.	Preserving and landscaping culture properties like shrines/hundi								
C.	Details of Sites for Project Ancillary facilities								

Sl. No.	Type of camp / site	Cumulative No of sites opened	No of sites operational	Cumulative No of sites redeveloped	Cumulative No of sites closed*	Remarks
1.	Construction camp					
2.	Labour camp					
3.	Quarry & stone crusher unit					
4.	Borrow Area					
5.	Debris disposal site					
6.	Water sources			NA		

* A site will be considered closed after redeveloping and obtaining closure certificate from CSC.

D. Summary of machinery and equipment available						
Sl. No.	Type of equipment / machinery / vehicles	Nos. available	Validity date of PUC certificate (as applicable)	Remarks		
1.						
E. Details of lapses and notices						
Sl. No.	Details of notices issued by CSC	Date of notice	Type of lapse (Major / Minor)	Notice No. *	Corrective actions taken	Remarks

*In case of minor lapse, specify whether original notice, first reminder or second reminder.					
F. REPORTING FORMATS TO BE ANNEXED WITH THIS MONTHLY REPORT BY THE CONTRACTOR					
SL. NO.	REPORTING FORMAT	YES/NO	SL. NO	REPORTING FORMAT	YES/NO
1	Format for Register of sites opened and closed and its reporting		8	Reporting Format for Register of Accidents and it's Reporting	
2	Format for Register of complaints and its reporting		9	Reporting Format for Enhancement and Mitigation of Cultural Properties	
3	Reporting Format for Work Force Management		10	Reporting Format for Noise Barrier Construction	
4	Reporting Format for Occupational Health and Safety Measures		11	Reporting Format for Enhancement Measures Other than Cultural Properties	
5	Reporting Format for Top Soil Conservation		12	Reporting Format for Tree Plantation	
6	Reporting Format for Water Sprinkling for Dust Suppression		13	Reporting Format for Environmental Quality Monitoring	
7	Reporting Format for Road Safety Measures During Construction		-	-	-
G. SUBMISSION DETAILS	SUBMITTED BY (ENVIRONMENT & SAFETY ENGINEER OF CONTRACTOR)		APPROVED BY (ENVIRONMENTAL OFFICER OF CSC)		
Signature & date					
Name					
Designation					
Remarks by CSC					

ANNEXURE 3.47 REPORTING FORMAT FOR MONTHLY REPORT FROM CSC TO PMU

A	Project Details			Period of Reporting:					
1.	Name of project stretch and link no.								
2.	Name and address of the Contractor								
3.	Contract date and duration								
4.	Status of completion of the project								
B.	Physical Progress Report								
Sl. No.	Enhancement Measure	Physical target (Nos.)	Units carried over from previous month	Units started in reporting month	Units completed in reporting month	Units carried over to next month	Cumulative units completed till end of reporting month	% target completed	Remarks / reasons for delay
			(a)	(b)	(c)	(d=a+b-c)			
1.	Noise barrier								
2.	Hand pumps								
3.	Bus Shelter								
4.	Sign Boards								

Sl. No.	Enhancement Measure	Physical target (Nos.)	Units carried over from previous month	Units started in reporting month	Units completed in reporting month	Units carried over to next month	Cumulative units completed till end of reporting month	% target completed	Remarks / reasons for delay
			(a)	(b)	(c)	(d=a+b-c)			
5.	Preserving and landscaping the cultural properties like shrines and hundi								
6.	Constructing new well								
7.	providing new water taps								
8.	Parking space for auto rickshaws, cars and jeep								
9.	Landscaping of type C oxbow lands								
10.	Planting trees along road side								
11.	Planting trees on inner side of sound insulating wall								
12.	Providing 1.2 m. high fencing under via duct								
13.	Concrete flooring with slope drains and oil interceptors								

C. Details of Sites for Project Ancillary facilities						
Sl. No.	Type of camp / site	Cumulative No of sites opened	No of sites operational	Cumulative No of sites redeveloped	Cumulative No of sites closed*	Remarks
1.	Construction camp					
2.	Labour camp					
3.	Quarry & stone crusher unit					
4.	Borrow Area					
5.	Debris disposal site					
6.	Water sources			NA		
* A site will be considered closed after redeveloping and obtaining closure certificate from CSC.						
D. Summary of machinery and equipment available						
Sl. No.	Type of equipment / machinery / vehicles	Nos. available	Validity date of PUC certificate (as applicable)		Remarks	
1.						
E. Details of lapses and notices						
Sl. No.	Details of notices issued by CSC	Date of notice	Type of lapse (Major / Minor)	Notice No. *	Corrective actions taken by Contractor	Remarks

*In case of minor lapse, specify whether original notice, first reminder or second reminder.

F.		Details of major lapses for which notices were issued during the current reporting month			
SI. No.	List of major lapses	Date of issuing notice		Whether invoking penalty clause from next interim payment certificate is recommended?	Remarks
1.					
2.					
3.					
4.					

G.		Details of minor lapses for which notices were issued during the current reporting month				
SI. No.	List of minor lapses	Date of issuing notice			Whether invoking penalty clause from next interim payment certificate is recommended?	Remarks
		Original notice	First Reminder	Second Reminder		
2.						
3.						
4.						
5.						

6					
7					
8					
H	Reporting / Monitoring formats to be annexed with this monthly report by the CSC				
Sl. No.	Reporting / Monitoring format	Yes/No	Sl. No	Reporting / Monitoring format	Yes/No
1	Format for Register of sites opened and closed and its reporting		14	Checklist For Monitoring Of Construction Camp Management	
2	Format for Register of complaints and its reporting		15	Checklist For Monitoring Of Labour Camp Management	
3	Reporting Format for Work Force Management		16	Checklist For Monitoring Of Quarry And Stone Crusher Management	
4	Reporting Format for Occupational Health and Safety Measures		17	Checklist For Monitoring Of Borrow Area Management	
5	Reporting Format for Top Soil Conservation		18	Checklist For The Monitoring Of Debris Disposal Site Management	
6	Reporting Format for Water Sprinkling for Dust Suppression		19	Check List For Monitoring Of Redevelopment Of Construction Camp Site	
7	Reporting Format for Road Safety Measures During Construction		20	Check List For Monitoring Of Redevelopment Of Labour Camp Site	-

8	Reporting Format for Register of Accidents and it's Reporting		21	Check List For Monitoring Of Redevelopment Of Quarry And Stone Crusher Site	
9	Reporting Format for Enhancement and Mitigation of Cultural Properties		22	Check List For Monitoring Of Redevelopment Of Borrow Areas	
10	Reporting Format for Noise Barrier Construction		23	Check List For Monitoring Of Redevelopment Of Debris Disposal Site	
11	Reporting Format for Enhancement Measures Other than Cultural Properties				
12	Reporting Format for Tree Plantation				
13	Reporting Format for Environmental Quality Monitoring				
I. SUBMISSION DETAILS	SUBMITTED BY (Environmental officer of CSC)		APPROVED BY (ENVIRONMENTAL Engineer of PMU)		
Signature & date					
Name					
Designation					
Remarks by PMU					

ANNEXURE 3.48 LIST OF PERMISSIONS TO BE OBTAINED BY THE CONTRACTOR

Sl. No	Type of Clearance	Statutory Authority	Applicability	Project Stage	Responsibility
1	Consent to Establish under the Air (Prevention & Control of Pollution) Act, 1981 and The Water (Prevention & Control of Pollution) Act, 1974.	Tamil Nadu State Pollution Control Board	For operating hot mix plants, crushers and construction camps	Construction (Prior to work initiation)	Contractor
2	Consent to Operate under the Air (Prevention & Control of Pollution) Act, 1981 and The Water (Prevention & Control of Pollution) Act, 1974.	Tamil Nadu State Pollution Control Board	For operating hot mix plants, crushers and construction camps	Construction (Prior to work initiation)	Contractor
3	Permission to store Hazardous Materials under Hazardous Waste (Management and Handling) Act 1989	Tamil Nadu State Pollution Control Board	Storage and Transportation of Hazardous Materials and Explosives	Construction (Prior to work initiation)	Contractor
4	Explosive license under The Explosives Act (& Rules), 1884 (revised in 1983)	Chief Controller of Explosives, petroleum & Explosive Safety Organization	Storage of explosive materials	Construction (Prior to work initiation)	Contractor
5	PUC certificate for vehicles for construction under Central Motor and Vehicle Act 1988	Motor Vehicle Department of Tamil Nadu	For all construction vehicles	Construction (Prior to work initiation)	Contractor
6	Quarry lease deeds and license under The Mines Act, 1958 *	Mining and Geology Department of Tamil Nadu	Quarrying and borrowing operations	Construction (Prior to work initiation)	Contractor
7	Consent for ground water extraction	Tamil Nadu Ground Water Authority	Ground water extraction for construction camps	Construction (Prior to work initiation)	Contractor

8	Consent for establishment of labour camp	Labour department of Tamil Nadu	Labour camps	Construction (Prior to work initiation)	Contractor
9	Consent to establish borrow area*	Local Panchayat / Municipality	Borrow area	Construction (Prior to work initiation)	Contractor

Sl. No	Type of Clearance	Statutory Authority	Applicability	Project Stage	Responsibility
10	Consent to Operate under the Air (Prevention & Control of Pollution) Act, 1981	Tamil Nadu State Pollution Control Board	For establishing Hot mix plants, Crushers, construction camps and batching plants	Operation	Contractor
11	Consent to Operate under the Water (Prevention & Control of Pollution) Act, 1974	Tamil Nadu State Pollution Control Board	For discharging of domestic waste water through soak pit	Operation	Contractor

* In the case of quarry, burrow areas and sand mining sites, if the contractor does not owe the sites, the contractor has to ensure that the material is obtained from approved sites as per MoEF guidelines dated 18th May, 2012.

ANNEXURE 3.49 SCHEMATIC DIAGRAM OF CATCH DRAIN AND OIL INTERCEPTORS

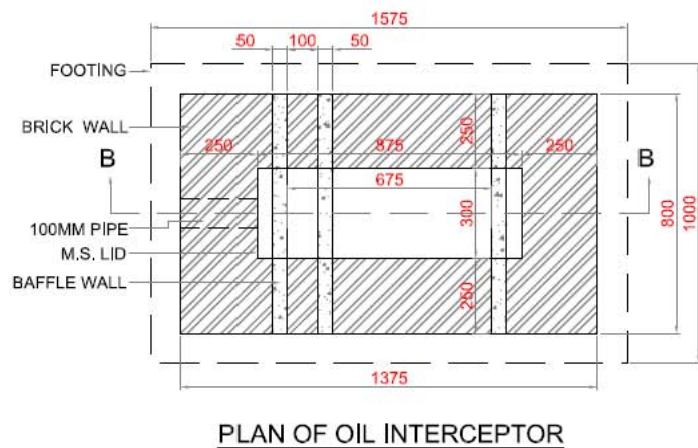
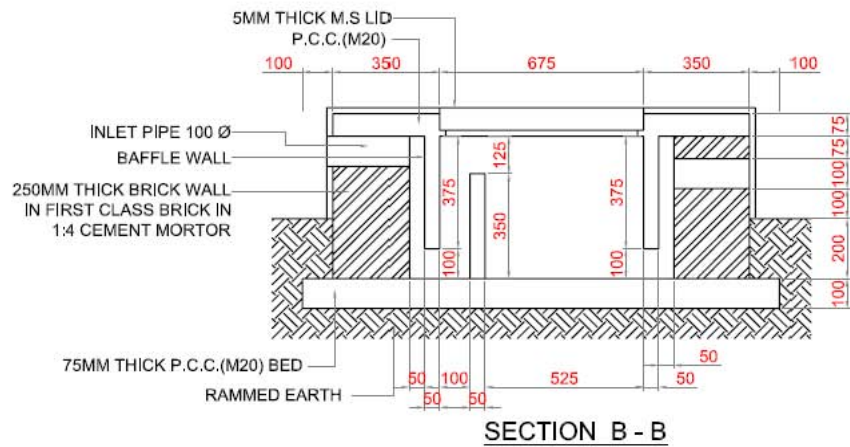
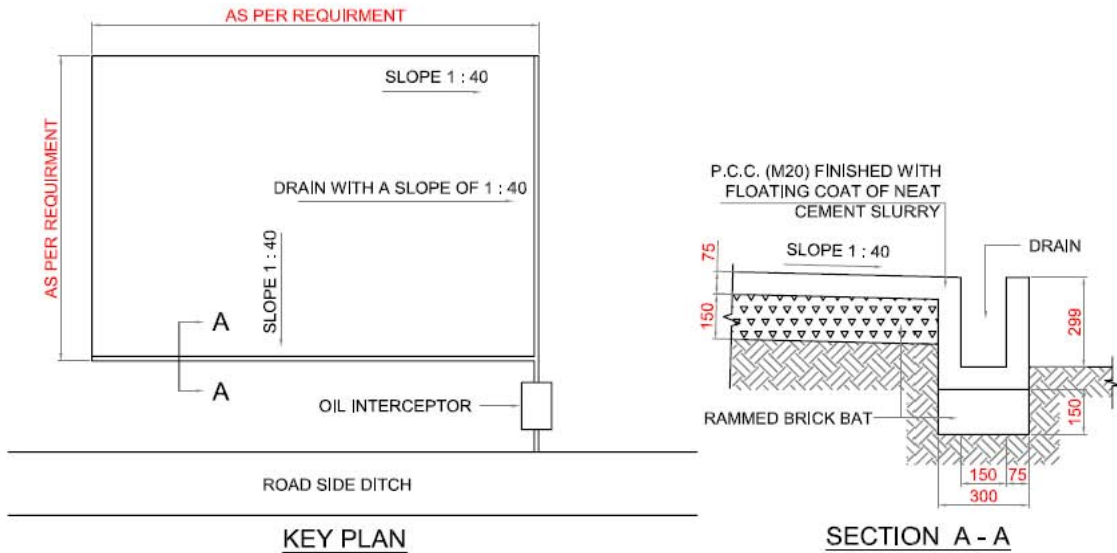

**ANNEXURE 3.50 PROPOSED CHAINAGES OF RETAINING WALL LOCATION
WHERE EMBANKMENT HEIGHT WILL BE RAISED**

S. No.	Chainage		Length of raising section (m)	Reason for raising
	From	To		
1	30/080	30/180	100	Vertical Geometric Improvement due submergence
2	32/980	33/080	100	Vertical Geometric Improvement due submergence
3	35/365	35/465	100	Vertical Geometric Improvement due submergence
4	35/865	35/965	100	Vertical Geometric Improvement due submergence
5	36/800	36/850	50	Vertical Geometric Improvement due submergence
6	37/550	37/675	125	Vertical Geometric Improvement due submergence
7	39/800	39/900	100	Vertical Geometric Improvement due submergence
8	40/000	40/200	200	Vertical Geometric Improvement due submergence
9	43/150	43/250	100	Vertical Geometric Improvement due submergence
10	43/545	43/745	200	Vertical Geometric Improvement due submergence
11	44/240	44/340	100	Vertical Geometric Improvement due submergence
12	51/000	51/200	200	Vertical Geometric Improvement due submergence
13	51/500	51/800	300	Vertical Geometric Improvement due submergence
14	59/450	59/550	100	Vertical Geometric Improvement due submergence
15	60/650	60/750	100	Vertical Geometric Improvement due submergence
16	61/350	61/450	100	Vertical Geometric Improvement due submergence
17	65/550	65/650	100	Vertical Geometric Improvement due submergence
18	67/250	67/350	100	Vertical Geometric Improvement due submergence
19	68/850	68/950	100	Vertical Geometric Improvement due submergence
20	70/250	70/350	100	Vertical Geometric Improvement due submergence

(Height of Raising > 0.5m)

ANNEXURE 3.51 SENSITIVE NOISE RECEPTORS

Sl. No.	Chainage (Km.)	Name of Common Property	Location (Left / Right)	Distance from PCL (m)	Impact	Mitigation/Enhancement
1	24.625	School	Left	30.8	No Direct	Tree Plantation. Horn prohibited sign post will be provided
2	29.500	School	Right	7	Direct	Demolition of structure up to 1m inside
3	29.800	Hospital	Right	5	Direct	Demolition of structure up to 3m inside
4	29.900	School	Left	10.5	No Direct	Horn prohibited sign post will be provided
5	30.600	School	Left	6	Direct	Existing boundary wall shifting. Tree Plantation. Horn prohibited sign post will be provided
6	30.600	School	Left	23.5	No Direct	Tree Plantation. Horn prohibited sign post will be provided
7	31.650	School	Left	27	No Direct	Boundary wall will be developed as noise barrier. Tree Plantation. Horn prohibited sign post will be provided
8	32.550	School	Right	10.5	No Direct	Existing boundary wall will be raised and develop as noise barrier. Tree Plantation. Horn prohibited sign post will be provided
9	34.500	College	Left	16.5	No Direct	Tree Plantation. Horn prohibited sign post will be provided
10	35.400	School	Left	26	No Direct	Tree Plantation. Horn prohibited sign post will be provided
11	37.600	Hospital	Left	10.5	No Direct	Boundary wall will be developed as noise barrier. Tree Plantation. Horn prohibited sign post will be provided
12	37.575	School	Right	7	Direct	Existing boundary wall shifting. Tree Plantation. Horn prohibited sign post will be provided
13	43.400	School	Right	16	No Direct	Boundary wall will be developed as noise barrier. Tree Plantation. Horn prohibited sign post will be provided
14	43.850	School	Right	26.5	No Direct	Boundary wall will be developed as noise barrier. Tree Plantation. Horn prohibited sign post will be provided
15	43.900	School	Left	7	Direct	Shifting of boundary wall will be developed as noise barrier. Tree Plantation. Horn prohibited sign post will be provided
16	86.510	School	Right	13.5	No Direct	Tree Plantation. Horn prohibited sign post will be provided
17	86.834	Training Centre	Left	19	No Direct	Tree Plantation. Horn prohibited sign post will be provided
18	90.750	School	Right	10	Direct	Shifting of boundary wall will be developed as noise barrier. Tree Plantation. Horn prohibited sign post will be provided

Sl. No.	Chainage (Km.)	Name of Common Property	Location (Left / Right)	Distance from PCL (m)	Impact	Mitigation/Enhancement
19	95.800	School	Left	45	No Direct	Tree Plantation. Horn prohibited sign post will be provided
20	95.800	Hostel	Right	45	No Direct	Tree Plantation. Horn prohibited sign post will be provided
21	95.800	Church+ Hospital+ School	Left	15.5	No Direct	Tree Plantation. Horn prohibited sign post will be provided
22	99.850	School	Left	16.5	No Direct	Boundary wall will be developed as noise barrier. Tree Plantation. Horn prohibited sign post will be provided
23	101.075	ITI	Right	15.5	No Direct	Boundary wall will be developed as noise barrier. Tree Plantation. Horn prohibited sign post will be provided
24	101.490	School	Left	15.5	No Direct	Boundary wall will be developed as noise barrier. Tree Plantation. Horn prohibited sign post will be provided
25	102.900	Hospital	Right	13.5	No Direct	Boundary wall will be developed as noise barrier. Tree Plantation. Horn prohibited sign post will be provided
26	106.300	School	Left	36	No Direct	Boundary wall will be developed as noise barrier. Tree Plantation. Horn prohibited sign post will be provided
27	106.350	School	Left	20	No Direct	Boundary wall will be developed as noise barrier. Tree Plantation. Horn prohibited sign post will be provided
28	107.150	School	Left	7	Direct	Shifting of boundary wall will be developed as noise barrier. Tree Plantation. Horn prohibited sign post will be provided
29	107.900	School	Right	36	No Direct	Boundary wall will be developed as noise barrier. Tree Plantation. Horn prohibited sign post will be provided
30	108.600	College	Right	12.5	No Direct	Boundary wall will be developed as noise barrier. Tree Plantation. Horn prohibited sign post will be provided
31	109.200	School	Left	10.5	Direct	Boundary wall will be developed as noise barrier. Tree Plantation. Horn prohibited sign post will be provided
32	109.850	School	Left	12	No Direct	Tree Plantation. Horn prohibited sign post will be provided
33	112.250	School	Right	39.5	No Direct	Boundary wall will be developed as noise barrier. Tree Plantation. Horn prohibited sign post will be provided
34	114.25	School	Left	15.5	No Direct	Tree Plantation. Horn prohibited sign post will be provided
35	80.900	School	Left	9.5	No Direct	Tree Plantation. Horn prohibited sign post will be provided
36	79.700	Hospital	Right	16.5	No Direct	Tree Plantation. Horn prohibited sign post will be provided
37	53.150	School	Right	19.5	No Direct	Tree Plantation. Horn prohibited sign post will be provided

Sl. No.	Chainage (Km.)	Name of Common Property	Location (Left / Right)	Distance from PCL (m)	Impact	Mitigation/Enhancement
38	72.400	School	Right	42	No Direct	Tree Plantation. Horn prohibited sign post will be provided
39	63.950	School	Left	11	Direct	Shifting of boundary wall will be developed as noise barrier. Tree Plantation. Horn prohibited sign post will be provided
40	74.425	School	Right	17.5	No Direct	Tree Plantation. Horn prohibited sign post will be provided
41	64.300	Hospital	Right	12	No Direct	Tree Plantation. Horn prohibited sign post will be provided
42	63.750	Hostel	Right	43.5	No Direct	Tree Plantation. Horn prohibited sign post will be provided
43	56.650	Training Centre	Left	16	No Direct	Raise height of boundary wall. Tree Plantation. Horn prohibited sign post will be provided

**ANNEXURE 3.52 WATER BODIES: IMPACT, MITIGATION
AND ENHANCEMENT**

Sl. No.	Chainage (Km.)	Name of Common Property	Location (Left / Right)	Distance from PCL (m)	Impact	Mitigation/Enhancement
1	38.425	River	Crossing	-	Direct Impact	Tree plantation Retaining wall on road side
2	40.550	Pond	Left	5	Direct Impact	Tree plantation Retaining wall on road side
3	43.400	Pond	Left	10.5	Direct Impact	Tree plantation Retaining wall on road side
4	85.800	Pond	Left	8	Direct Impact	Tree plantation Retaining wall on road side
5	96.300	Pond	Right	8.5	Direct Impact	Tree plantation Retaining wall on road side

ANNEXURE 3.53: SCHEDULE AND SPECIFICATIONS FOR MITIGATION AND ENHANCEMENT MEASURES

S No.	Location (Chainage in km)	Side (LHS/RHS)	Length(m)	Breadth (m)	Height (m)	Materials to be used (Specification)	Typical (refer No.)	Drawing Drawing No.)
Community Properties (Water Bodies)								
1	40.55	Left	875	0.6	3	Reinforced Cement Concrete		
2	43.4	Left	28	0.6	3			
3	85.8	Left	50	0.6	3			
4	96.3	Right	34	0.6	3			
5	45.7	Right	55	0.6	3			
6	57.816	Left	70	0.6	3			
7	59.05	Right	42	0.6	3			
8	64.469	Right	99	0.6	3			
9	65.2	Left	77	0.6	3			
10			Lumpsum			Desilting of pond is proposed to enhance the capacity of the pond as a part of environmental enhancement measures		
11						Plantation of 534 trees is proposed along the peripheri of pond as a environmental mitigation and enhancement measures		
Community Properties (School/hospital etc)								
12	30.6	Left	24	0.23	1.5	Brickworks	Refer Figure 8.4 of Chapter 8 of EA Report	
13	37.575	Right	36.5	0.23	1.5			
14	43.85	Right	19.5	0.23	1.5			
15	43.9	Left	15	0.23	1.5			
16	56.65	Left	19.5	0.23	0.3			

S No.	Location (Chainage in km)	Side (LHS/RHS)	Length(m)	Breadth (m)	Height (m)	Materials to be used (Specification)	Typical (refer No.)	Drawing Drawing No.)
17	63.95	Left	266	0.23	1.5			
18	90.75	Right	13	0.23	1.5			
19	99.85	Left	65	0.23	1.5			
20	101.08	Right	75	0.23	1.5			
21	101.49	Left	56	0.23	1.5			
22	102.9	Right	82	0.23	1.5			
23	106.3	Left	82	0.23	1.5			
24	106.35	Left	13.5	0.23	1.5			
25	107.15	Left	104.2	0.23	1.5			
26	107.9	Right	8.5	0.23	1.5			
27	108.6	Right	72	0.23	1.5			
28	109.2	Left	31.5	0.23	1.5			
29	112.25	Right	16	0.23	1.5			
30						Plantation of 1090 trees is proposed along the boundary wall as noise barrier as a environmental mitigation and enhancement measures	Plantation	
31	30.6	Left	35	rm		Demolition		
32	30.6	Left	1	no.		Provision of Gate		
33	37.575	Right	47	rm		Demolition		
34	37.575	Right	1	no.		Provision of Gate		
35	43.85	Right	1	no.		Provision of Gate		
36	43.9	Left	18	rm		Demolition		
37	43.9	Left	1	no.		Provision of Gate		
38	63.95	Left	267	rm		Demolition		
39	90.75	Right	16	rm		Demolition		

S No.	Location (Chainage in km)	Side (LHS/RHS)	Length(m)	Breadth (m)	Height (m)	Materials to be used (Specification)	Typical (refer No.)	Drawing (Drawing No.)
40	90.75	Right	1	no.		Provision of Gate		
41	99.85	Left	1	no.		Provision of Gate		
42	101.08	Right	1	no.		Provision of Gate		
43	101.49	Left	1	no.		Provision of Gate		
44	102.9	Right	1	no.		Provision of Gate		
45	106.3	Left	1	no.		Provision of Gate		
46	106.35	Left	1	no.		Provision of Gate		
47	107.9	Right	1	no.		Provision of Gate		
48	108.6	Right	1	no.		Provision of Gate		
49	109.2	Left	1	no.		Provision of Gate		
50	112.25	Right	1	no.		Provision of Gate		
Community Structures i.e. Temples etc.								
29	29.7	Right	5	0.2	1.5	Brickworks	Refer Figure 8.4 of Chapter 8 of EA Report	
30	31.5	Right	18	0.2	1.5			
31	32.9	Right	9.8	0.2	1.5			
32	36.75	Right	19	0.2	1.5			
33	52.45	Right	25.5	0.2	1.5			
34	65.88	Right	21	0.2	1.5			
35	67.862	Right	12.5	0.2	1.5			
36	77.725	Left	11.2	0.2	1.5			
37	81.5	Right	29.5	0.2	1.5			
38	85.425	Right	6.5	0.2	1.5			
39	99.225	Left	4.5	0.2	1.5			
40	101.95	Right	13.5	0.2	1.5			
41	113.25	Right	5	0.2	1.5			

S No.	Location (Chainage in km)	Side (LHS/RHS)	Length(m)	Breadth (m)	Height (m)	Materials to be used (Specification)	Typical (refer No.)	Drawing Drawing No.)
42						Plantation of 91 trees is proposed along the boundary wall as noise barrier as a environmental mitigation and enhancement measures		
43	29.3	Left	1.5	rm		Demolition of platform		
44	29.3	Left	1	No.		Seating Bench		
45	29.7	Right	14	rm		Demolition of boundary wall		
46	29.7	Right	1	No.		Gate		
47	29.8	Left	1	No.		Demolition of gate		
48	29.8	Left	1	No.		Gate		
49	29.9	Right	4	rm	sheesh99	Demolition of platform		
50	29.9	Right	4	rm		Demolition of platform		
51	31.5	Right	23	rm		Demolition of boundary wall		
52	31.5	Right	1	No.		Seating Bench		
53	31.5	Right	1	No.		Gate		
54	32.9	Right	12	rm		Demolition of boundary wall		
55	32.9	Right	1	No.		Seating Bench		
56	32.9	Right	1	No.		Gate		
57	36.75	Right	20	rm		Demolition of boundary wall		
58	36.75	Right	1	No.		Seating Bench		
59	36.75	Right	1	No.		Gate		
60	37.65	Right	1	No.		Demolition of Gate		

S No.	Location (Chainage in km)	Side (LHS/RHS)	Length(m)	Breadth (m)	Height (m)	Materials to be used (Specification)	Typical (refer No.)	Drawing Drawing No.)
61	37.65	Right	2	No.		Seating Bench		
62	37.65	Right	1	No.		Gate		
63	41.45	Right	1	No.		Demolition of mandapam		
64	41.45	Right	1	No.		Seating Bench		
65	42.575	Right	13	rm		Demolition of structure		
66	42.575	Right	2	No.		Seating Bench		
67	42.575	Right	1	No.		Gate		
68	52.45	Right	26	rm		Demolition of boundary wall		
69	52.45	Right	2	No.		Seating Bench		
70	52.45	Right	1	No.		Gate		
71	65.88	Right	28	rm		Demolition of boundary wall		
72	65.88	Right	2	No.		Seating Bench		
73	65.88	Right	1	No.		Gate		
74	67.35	Right	11	rm		Demolition		
75	67.862	Right	18.5	rm		Demolition of boundary wall		
76	67.862	Right	1	No.		Seating Bench		
77	67.862	Right	1	No.		Gate		
78	77.725	Left	4	rm		Demolition of boundary wall		
79	77.725	Left	1	No.		Gate		
80	81.5	Right	32.5	rm		Demolition of boundary wall		
81	81.5	Right	1	No.		Gate		
82	85.425	Right	8.5	rm		Demolition of boundary wall		
83	85.425	Right	1	No.		Gate		
84	99.225	Left	1	No.		Gate		

S No.	Location (Chainage in km)	Side (LHS/RHS)	Length(m)	Breadth (m)	Height (m)	Materials to be used (Specification)	Typical (refer No.)	Drawing Drawing No.)
85	101.95	Right	15.5	rm		Demolition of boundary wall		
86	101.95	Right	1	No.		Seating Bench		
87	101.95	Right	1	No.		Gate		
88	113.25	Right	6	rm		Demolition of boundary wall		
89	113.25	Right	1	No.		Gate		
Environmental Monitoring during Construction								
90								
91	Air Quality	Location	10	Nos		24 Hourly monitoring once in season for three seasons		
92	Noise Quality	Location	10	Nos		24 Hourly monitoring once in season for three seasons		
93	Water Quality	Location	5	Nos		Water Quality monitoring once in a season for three seasons		
94	Soil Quality	Location	5	Nos		Water Quality monitoring once in a season for three seasons		
Environmental Monitoring during Operation								
95	Air Quality	Location	9	Nos		24 Hourly monitoring once in season for three seasons for two years		
96	Noise Quality	Location	9	Nos		24 Hourly monitoring once in season for three seasons for two years		
97	Water Quality	Location	5	Nos		Water Quality monitoring once in a season for three seasons for two years		
98	Soil Quality	Location	5	Nos		Water Quality monitoring once in a season for three seasons for two years		
Compensatory Plantation								
99		Avenue Plantation	71870	Nos		Compensatory plantation and maintenance of sampling of 3 years		

S No.	Location (Chainage in km)	Side (LHS/RHS)	Length(m)	Breadth (m)	Height (m)	Materials to be used (Specification)	Typical Drawing (refer Drawing No.)
Other Items							
100		Oil Interceptor	3	Nos		Brickworks	Refer Figure 8.1 of Chapter 8 of EA Report
101		Silt fencing	4230	rm		Brickworks	Refer Figure 8.3 of Chapter 8 of EA Report

ANNEXURE 3.54 TREE PLANTING AND ENVIRONMENTAL ENHANCEMENT PLAN

TREE REMOVAL FROM THE AVAILABLE CORRIDOR OF THE ROAD

The road widening under the Tamil Nadu Road Sector Project (TNRSP) will necessitate removal of large number of trees from the roadsides. The list of tree removal is given in Annexure 4.5 of EA report.

ROAD SIDE AVENUE PLANTATION

In the TNRSP project corridors, there is almost continuous avenue plantation. The trees within the available corridors are surveyed and tabulated in Annexure 4.5 of EA report.. The common tree species found along the road are Banyan trees, Tamarind, Jamun, Gulmohar, Palm, Coconut, Peepal etc.

The total number of trees to be removed from SH 04 are estimated as 7187 numbers for a length of 86.24 km. The tree removal is largely based on the land requirement for widening and strengthening of existing proposed road and for road safety issues.

BENEFITS OF AVENUE PLANTING ALONG ROAD SIDES

- To produce a greener landscape.
- To give shade to travellers.
- To absorb excessive noise.
- To raise social forestry;
- To act as a natural filter to the traffic emissions.
- Tree planting control soil erosion and provide increased slope stability.

COMPENSATORY TREE PLANTING

The compensatory tree planting strategy is based on the survival rate. The survival rate in Tamil Nadu is good due to the favourable climatic conditions.

Public trees: The project will plant at least ten the number of trees that will be removed from the TNRSP-II road corridor. The compensatory planting for Maintenance of project roads will also be considered.

The total numbers of plants that will be necessary to be planted against the expected loss of 7187 trees is about 71870 trees for SH 04.

As an environmental enhancement measures, the project will also aim to plant shrubs in road divider and other places wherever space will be found suitable.

SELECTION OF LOCATIONS FOR AVENUE PLANTATION

Criteria adopted for selection of locations for avenue tree plantation is based on availability of land margin within road boundary. Proposed RoW of SH 04 varies from min. 16m to max. 23m depending on the landuse pattern of the corridor. The proposed right of way (PROW) is indicated in Table 1 below. Avenue plantation is proposed on both sides of the road at 10 m centre to centre (c/c).

TABLE 1.0: Proposed Right of Way

Start (KM)	End (KM)	ROW in m	Section	PRoW in m	Proposed lanes
24600	30475	16	Built up	16	2 lane
30475	31200	23	Rural	23	2 lane
31200	31600	16	Built up	16	2 lane
31600	32300	23	Rural	23	2 lane
32300	33000	16	Built up	16	2 lane
33000	37035	23	Rural	23	2 lane
37035	37640	16	Built up	16	2 lane
37640	39520	23	Rural	23	2 lane
39520	40100	16	Built up	16	2 lane
40100	43600	23	Rural	23	2 lane
43600	44100	16	Built up	16	2 lane
44100	45400	23	Rural	23	2 lane
45400	45700	16	Built up	16	2 lane
45700	48390	23	Rural	23	2 lane
48390	48500	16	Built up	16	2 lane
48490	49300	23	Rural	23	2 lane
49300	49740	16	Built up	16	2 lane
49740	50840	23	Rural	23	2 lane
50840	52930	16	Built up	16	2 lane
52930	64800	23	Rural	23	2 lane
64800	65300	16	Built up	16	2 lane
65300	66700	23	Rural	23	2 lane
66700	67020	16	Built up	16	2 lane
67020	69800	23	Rural	23	2 lane
69800	70325	16	Built up	16	2 lane
70325	77770	23	Rural	23	2 lane
77770	79100	16	Built up	16	2 lane
79100	79430	30	Rural	23	2 lane
79430	81050	16	Built up	16	2 lane
81050	81700	23	Rural	23	2 lane
81700	81900	16	Built up	16	2 lane
81900	82950	23	Rural	23	2 lane
82950	83965	16	Built up	16	2 lane
83965	86950	23	Rural	23	2 lane
86950	87200	16	Built up	16	2 lane
87200	89980	23	Rural	23	2 lane
89980	90600	16	Built up	16	2 lane
90600	94200	23	Rural	23	2 lane
94200	94500	16	Built up	16	2 lane
94500	95000	23	Rural	23	2 lane
95000	95500	16	Built up	16	2 lane
95500	96480	23	Rural	23	2 lane

Start (KM)	End (KM)	ROW in m	Section	PRoW in m	Proposed lanes
96480	96900	16	Built up	16	2 lane
96900	97200	23	Rural	23	2 lane
97200	97800	16	Built up	16	2 lane
97800	98500	23	Rural	23	2 lane
98500	99000	16	Built up	16	2 lane
99000	100900	23	Rural	23	2 lane
100900	101400	16	Built up	16	2 lane
101400	105990	23	Rural	23	2 lane
105990	106700	16	Built up	16	2 lane
106700	110000	23	Rural	23	2 lane
113300	114650	16	Built up	16	2 lane

SELECTION OF TREE SPECIES FOR PLANTING

The selection tree for planting is based on the tree species likely to be removed. The list of tree species to be planted along the phase I roads are given in **Table 4**. The recommended species are the same as that of the occurring species. Peepal and Bargad trees are avoided for avenue plantation while these can be planted at other locations like school, hospital, temple and pond.

Table 4.0: List of Trees for Plantation

Sr no	Botanical name	Common name
1.	<i>Tamarindus indica</i>	Tamrind
2.	<i>Azadirachta indica</i>	Neem
3.	<i>Borassus flaberiformis</i>	Tad palm
4.	<i>Phonix sylvestris</i>	Khajur palm
5.	<i>Ficus bengalensis</i>	Baragad
6.	<i>Ficus religiosa</i>	Papal
7.	<i>Syzygium cumini</i>	Jamun
8.	<i>Bombax ceiba</i>	Kante sawar
9.	<i>Bombax malabarica</i>	Silk cotton tree
10.	<i>Acacia nilotica</i>	Babool
11.	<i>Cassia auriculata</i>	Cassia
12.	<i>Acacia auriculoformis</i>	Australian acacia
13.	<i>Eucalyptus species</i>	Nilgiri
14.	<i>Casuarinas equisetifolia</i>	Suru
15.	<i>Ficus glomerata</i>	Umbar
16.	<i>Dalbergia sisoo</i>	Shisam
17.	<i>Prosopis julifera</i>	Prosopis

PLANTATION SPECIFICATIONS

DETAILS OF NURSERIES

Tamil Nadu Forest Department has facilities for raising nurseries at various places at division and sub-division level within the study area. Depending on necessity, nurseries can be raised in nearby private lands taken on short-term lease by TNFD.

Cost of plantation per tree is estimated as Rs 2200 which includes three years maintenance.

MONITORING FORMATS

Monitoring may be done on a bimonthly basis using the format given in Table 5.0.

TABLE 5.0 MONITORING FORMAT

LOCATION	SPECIES PLANTED	NO. OF PLANTS PLANTED	NO. OF PLANTS SURVIVING AND PERCENTAGE	AVERAGE HEIGHT	REMARK ON GENERAL HEALTH OF PLANTS

BIO MANURE

Bio manures like compost, Neem cake, Azatobactor are recommended instead of chemical fertilizers to make the scheme more eco friendly. About 10 gm Azatobactor together with 250 gram of Neem cake or compost shall be used at the time of planting and as part of 2nd and 3rd year maintenance. Neem cake will also function as bio pesticide. Compost can be made from green leaves, coconut husk or urban waste materials. Normally the tree species suggested do not suffer from attack of pests and application of Neem cake can be very effective prophylactic treatment.

MULCHING AND PRUNING

Mulching at the end of monsoon shall be done with coconut husk, grass or green leaves after under taking a soil working around the plant in order to conserve moisture. Frequent watering of trees shall also be carried out to protect them from severe summer. Pruning of branches during 2nd and 3rd year shall be carried out to ensure proper stem formation and to ensure that the branches will not obstruct the traffic on the road.

PAYMENT SCHEDULE

The major portion of the expenditure is at the pre planting and planting stages. Plantation will be carried out by the project contractor with first year maintenance and cost for the same is considered in BOQ. Second and third year maintenance will be carried out by contractor appointed by TNRSP.

NOISE BARRIER

Although dissipation of complete noise is expensive and difficult to implement, some cost effective methods can be employed to reduce the noise level considerably. In order to create a healthy noise barrier the following considerations would help.

The species selection should be very careful. The selected species should have small but presence of innumerable green leaves each small leaf acting as noise attenuator. The space available between the school or silence zone and the road corridor could be the deciding factor.

The number of rows required creates an effective noise shield for the given circumstances. This actually depend on the space available between the road corridor and the building

The design provided is an ideal situation especially with regard to the location of school gate, assembly area, and tree planting area (three rows of trees completely sealing the entry of direct noise).

The school activity area (ground for daily assembly, prayer meetings etc) should be planned away from the main high traffic road. This is applicable as guideline to new schools.

The School gate should be away from the main traffic road. If the situation does not permit, the gate should be in any corner in such a way that the noise effect from the main road is minimum.

Trees add to effectiveness of Noise barrier manifold. The species recommended for the tree planting is *Polyalthia longifolia* Var *Pendula* (Asoka tree). However depending on the situation any trees with numerous relatively small leaves will be ideal.

LINK SPECIFIC ACTION PLAN FOR TREE PLANTING

TREE PLANTING AWARENESS CAMPAIGN

An Environmental Monitoring Unit (EMU) under the Highway Department (HD) at Chennai will take up this activity coordinating with local Engineers of each affected district for Panchayat level awareness meetings. The Environmental Officer will be solely responsible for the various activities. The EO needs to identify and invite the local people to participate in the programme.

The parties to be invited include

- 1) Representatives of parents, Students and teachers of the Schools and other educational institutions bordering the Project road
- 2) Forest officials - They will supply seedlings of the appropriate varieties to the local people and to the schools for planting.
- 3) Project Management Unit (PMU of PWD) members
- 4) HD local Staff
- 5) NGOs in the region as the EO can select the most appropriate NGOs as the credibility of all NGOs can only be evaluated by their past activities.
- 6) Private Nursery owners
- 7) Panchayat representatives

Nurseries The forest nurseries of the Social forestry wing of the Department of Forests and Wild Life and also Tamilnadu Forest Department will provide the seedlings on a continuous basis.

Frequency of meetings There should be at least four meetings at local Panchayat levels per year to evaluate the programme after planting of the trees. The meeting shall be attended by representative of school children's and teachers at all levels of education in addition to Panchayat Authorities. The HD at State level should organize television and radio programmes in the local language.

Sources of Funding Tree plantation cost is already included in the contractor cost which is part of bid document, which also includes the planting for noise barriers. Contractor will carry out planting trees along the corridor as and when the road construction is complete. This way, survival rate of trees can be ensured. The rest has to be raised locally. In Tamil Nadu, the Panchayat authorities can provide local funding for organizing these meetings and action plans. The project provision for noise barriers also provides funding for schools and hospitals.

CONCLUSION & POLICY RECOMMENDATIONS

CONCLUSIONS

The project is committed to plant a minimum of 71870 trees as against the removal of 7187 trees.

RECOMMENDATIONS

After the construction of the road, there should be a determined effort to persuade the landowners on both sides to plant shade trees along safe sections and to discourage at unsafe sections. This activity shall be at micro level i.e. at the Panchayat or village level with people's involvement. The household should know why these activities are required. There should be a determined effort by local schools, hospitals, Panchayat Municipal and Police authorities towards this. The PMU will take up this activity for further follow up with a definitive action plan.

The strategy discussed is a general approach, depending upon the local situation; there can be variations.

HD will have to develop a monitoring mechanism for tree plantation along the road and other location during operational stage to have an excellent control on the land and resources. HD should consider the employment of local people for planting.

Notes: This recommendation does not affect the existing trees. Wherever possible, the existing trees have been protected by making necessary design changes.

ANNEXURE3.55 ENVIRONMENTAL ENHANCEMENT DRAWINGS, BOQ AND COST

MITIGATION/ENHANCEMENT OF COMMUNITY PROPERTIES

Surface Water Bodies along SH 04

VILLUPURAM

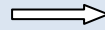

ARNI

Chainage (km)	40+550	
Structure ID No	Pond	
Village Name	Vinnamangal	
Side (Left/Right)	Left	
Distance from PCL (m)	5	
Length x Breadth (m)	875 x 600	
Proposed ROW (Equal on either side of PCL) (m)	11.5	
Impact	direct impact	

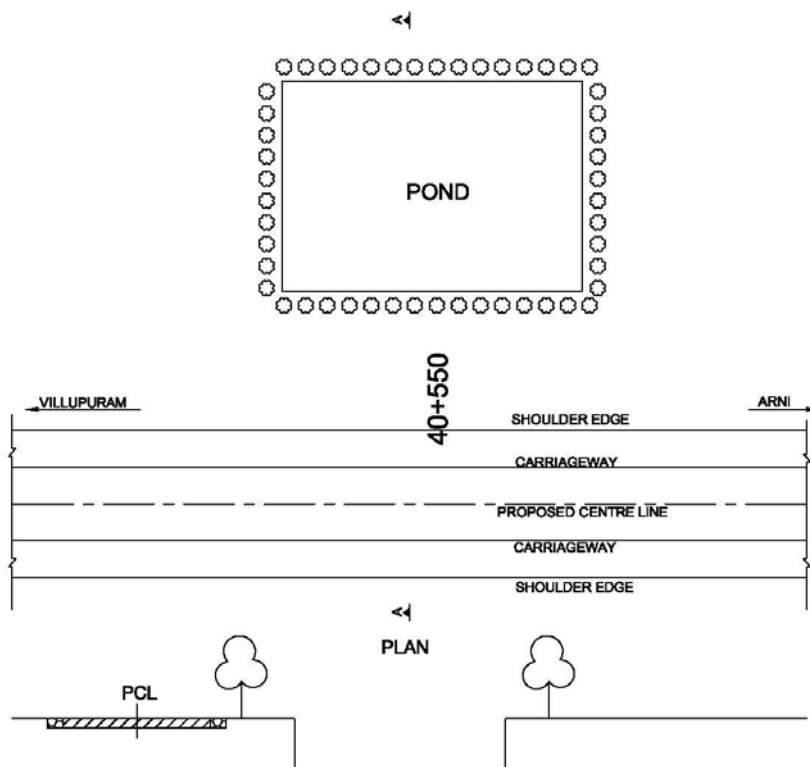

MITIGATION/ENHANCEMENT

S. No.	Description	Unit	Quantity	Rate (Rs.)	Amount (Rs.)	BOQ Item No.
1	Tree plantation	No.	295			2.1
2	Retaining wall on road side	rm	875			6.3
3	Disilting	No	1			
Total						

Chainage (km)	43+400	
Structure ID No	Pond	
Village Name	Kollappalur	
Side (Left/Right)	Left	
Distance from PCL (m)	10.5	
Length x Breadth (m)	28 x 28	
Proposed ROW (Equal on either side of PCL) (m)	11.5	
Impact	direct impact	

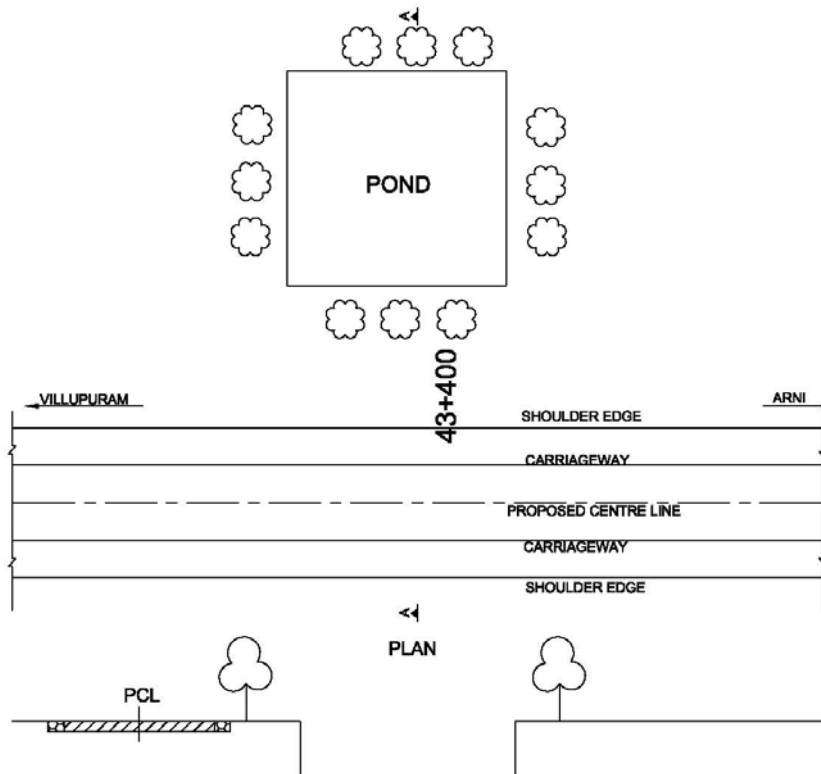

MITIGATION/ENHANCEMENT

S. No.	Description	Unit	Quantity	Rate (Rs.)	Amount (Rs.)	BOQ Item No.
1	Tree plantation	No.	11			2.1
2	Retaining wall on road side	rm	28			6.3
3	Disilting	No	1			
Total						

Chainage (km)	85+800	
Structure ID No	Pond	
Village Name	Sitampondi	
Side (Left/Right)	Left	
Distance from PCL (m)	8	
Length x Breadth (m)	50 x 300	
Proposed ROW (Equal on either side of PCL) (m)	11.5	
Impact	direct impact	

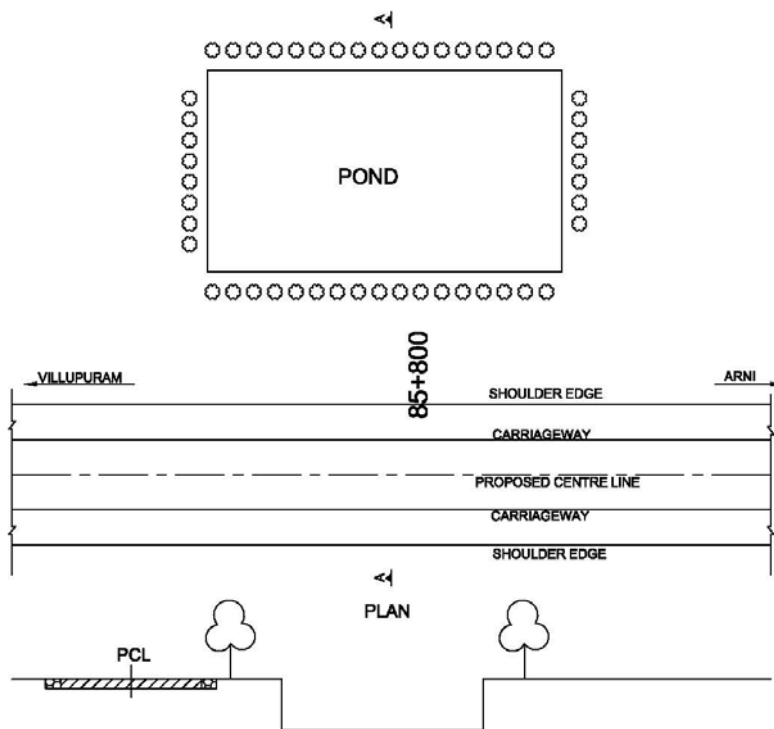

MITIGATION/ENHANCEMENT

S. No.	Description	Unit	Quantity	Rate (Rs.)	Amount (Rs.)	BOQ Item No.
1	Tree plantation	No.	70			2.1
2	Retaining wall on road side	rm	50			6.3
3	Disilting	No	1			
Total						

Chainage (km)	96+300	
Structure ID No	Pond	
Village Name	Muttathur	
Side (Left/Right)	Right	
Distance from PCL (m)	8.5	
Length x Breadth (m)	34 x 25	
Proposed ROW (Equal on either side of PCL) (m)	11.5	
Impact	direct impact	

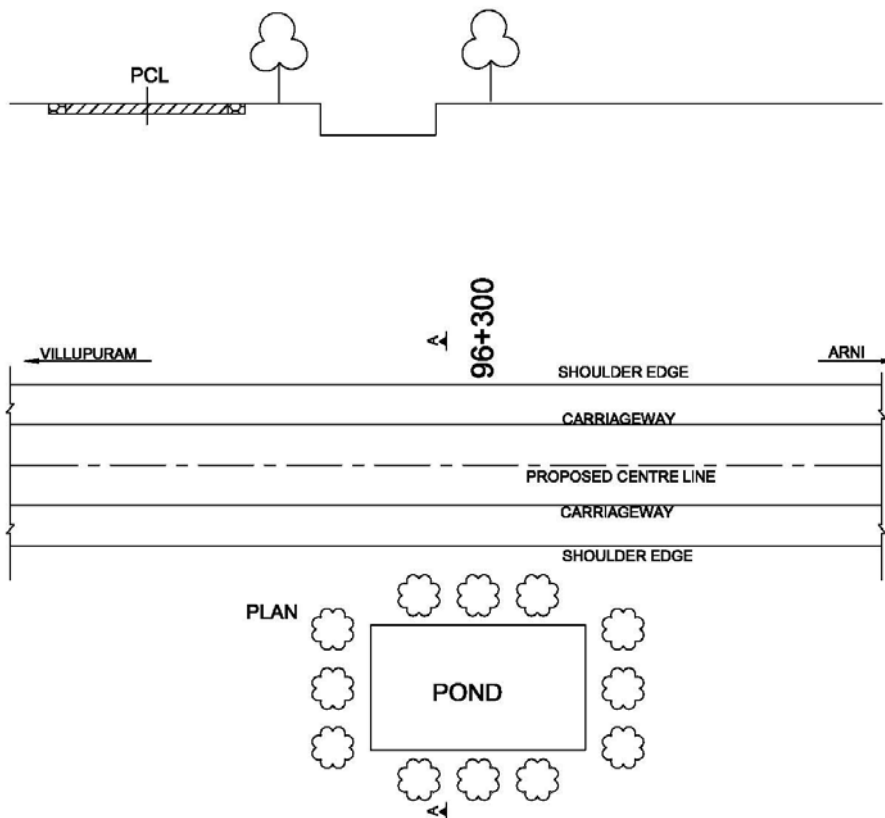

MITIGATION/ENHANCEMENT

S. No.	Description	Unit	Quantity	Rate (Rs.)	Amount (Rs.)	BOQ Item No.
1	Tree plantation	No.	12			2.1
2	Retaining wall on road side	rm	34			6.3
3	Disilting	No	1			
Total						

Chainage (km)	45+700	
Structure ID No	Pond	
Village Name	Chammambadi	
Side (Left/Right)	Right	
Distance from PCL(m)	10	
Length x Breadth(m)	55 x 55	
Proposed ROW (Equal on either side of PCL) (m)	11.5	
Impact	direct impact	

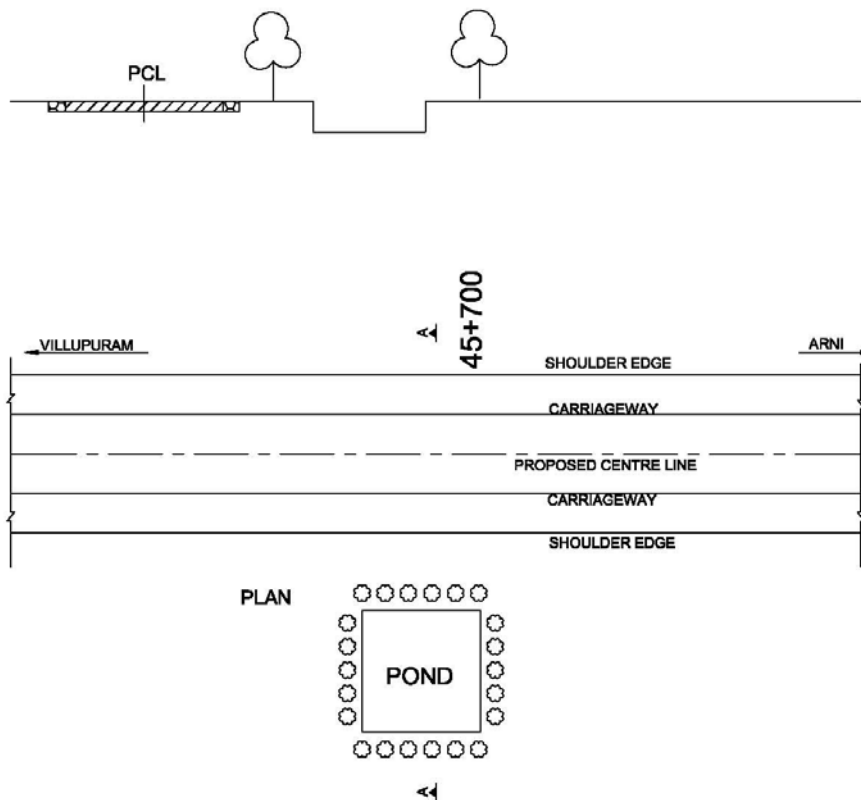

MITIGATION/ENHANCEMENT

S. No.	Description	Unit	Quantity	Rate (Rs.)	Amount (Rs.)	BOQ Item No.
1	Tree plantation	No.	22			2.1
2	Retaining wall on road side	rm	55			6.3
3	Disilting	No	1			
Total						

Chainage (km)	57+816	
Structure ID No	Pond	
Village Name	Arul nadu	
Side (Left/Right)	Left	
Distance from PCL(m)	10	
Length x Breadth(m)	70 x 140	
Proposed ROW (Equal on either side of PCL) (m)	11.5	
Impact	direct impact	

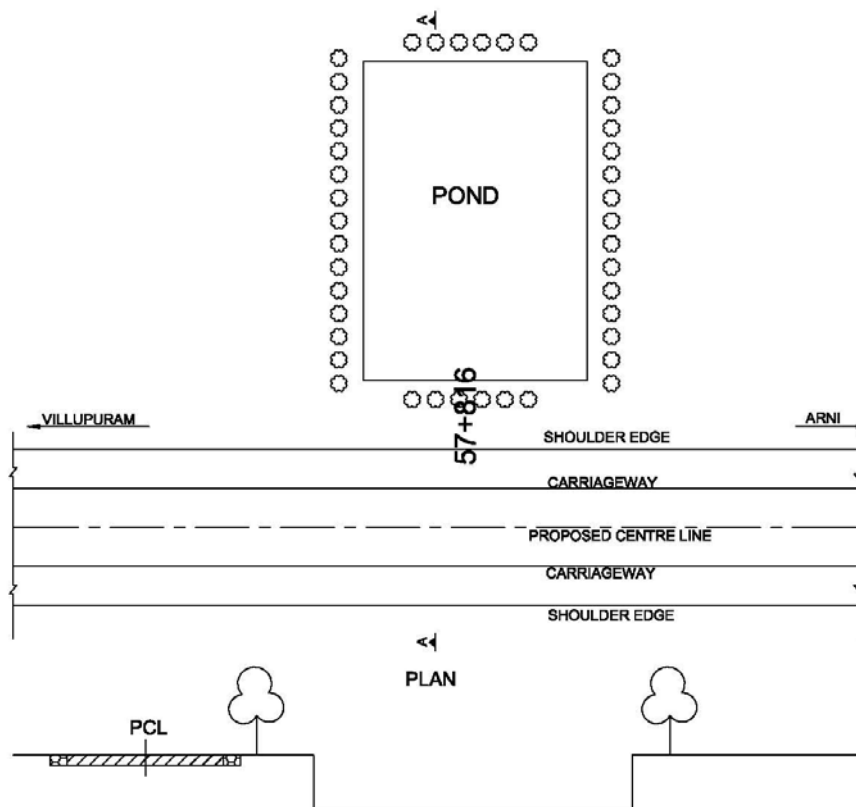

MITIGATION/ENHANCEMENT

S. No.	Description	Unit	Quantity	Rate (Rs.)	Amount (Rs.)	BOQ Item No.
1	Tree plantation	No.	42			2.1
2	Retaining wall on road side	rm	70			6.3
3	Disilting	No	1			
Total						

Chainage (km)	59+050	
Structure ID No	Pond	
Village Name	Kooduvampondi	
Side (Left/Right)	Right	
Distance from PCL(m)	5.5	
Length x Breadth(m)	42. x 42	
Proposed ROW (Equal on either side of PCL) (m)	11.5	
Impact	direct impact	

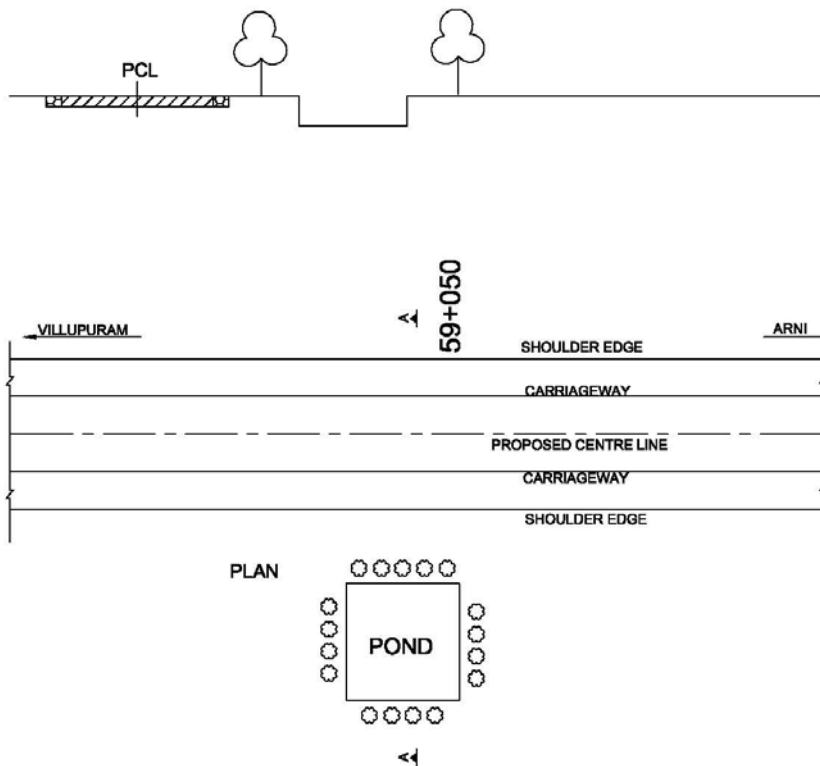

MITIGATION/ENHANCEMENT

S. No.	Description	Unit	Quantity	Rate (Rs.)	Amount (Rs.)	BOQ Item No.
1	Tree plantation	No.	17			2.1
2	Retaining wall on road side	rm	42			6.3
3	Disilting	No	1			
Total						

Chainage (km)	64+469	
Structure ID No	Pond	
Village Name	Valathy	
Side (Left/Right)	Right	
Distance from PCL(m)	9	
Length x Breadth(m)	99 x 70	
Proposed ROW (Equal on either side of PCL) (m)	11.5	
Impact	direct impact	

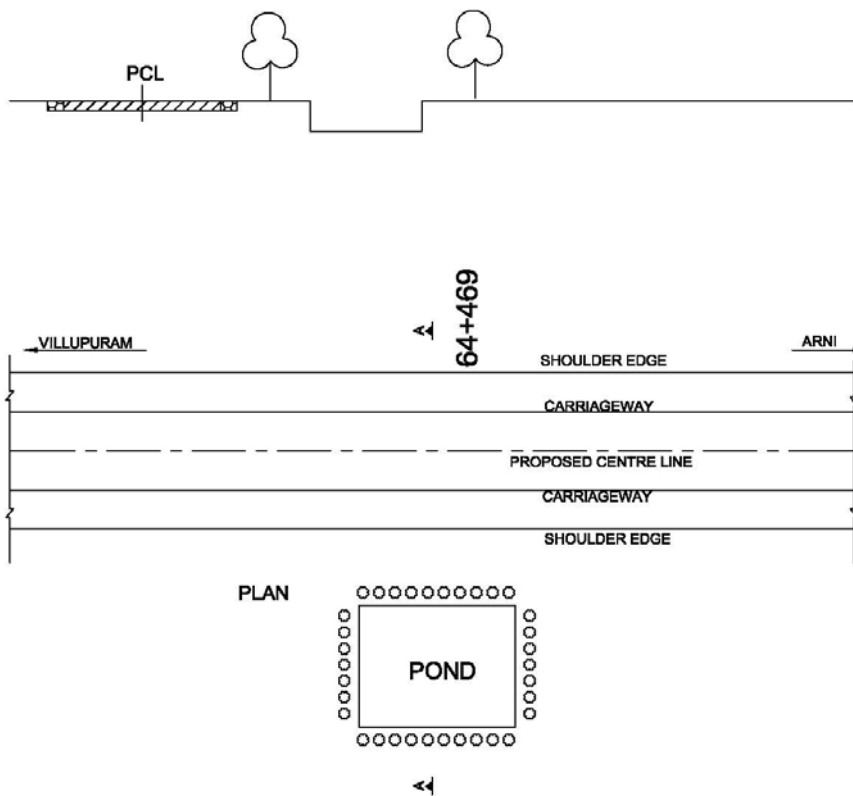

MITIGATION/ENHANCEMENT

S. No.	Description	Unit	Quantity	Rate (Rs.)	Amount (Rs.)	BOQ Item No.
1	Tree plantation	No.	34			2.1
2	Retaining wall on road side	rm	99			6.3
3	Disilting	No	1			
Total						

Chainage (km)	65+200
Structure ID No	Pond
Village Name	Valathy
Side (Left/Right)	Left
Distance from PCL(m)	5.5
Length x Breadth(m)	77 x 77
Proposed ROW (Equal on either side of PCL) (m)	8
Impact	direct impact

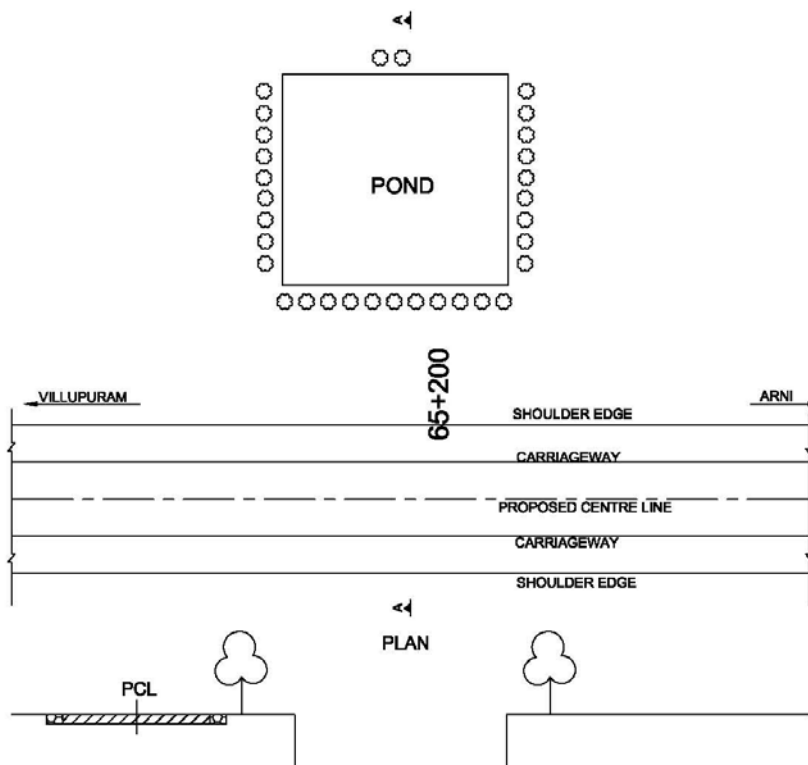

MITIGATION/ENHANCEMENT

S. No.	Description	Unit	Quantity	Rate (Rs.)	Amount (Rs.)	BOQ Item No.
1	Tree plantation	No.	31			2.1
2	Retaining wall on road side	rm	77			6.3
3	Disilting	No	1			
Total						

Sensitive Receptors along SH 04

VILLUPURAM

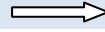

ARNI

Chainage (km)	24+625
Structure ID No	School
Village Name	Irimbedi
Side (Left/Right)	Left
Distance from PCL (m)	30.8
Length x Breadth (m)	70 x 35
Proposed ROW (Equal on either side of PCL) (m)	8
Impact	No direct impact

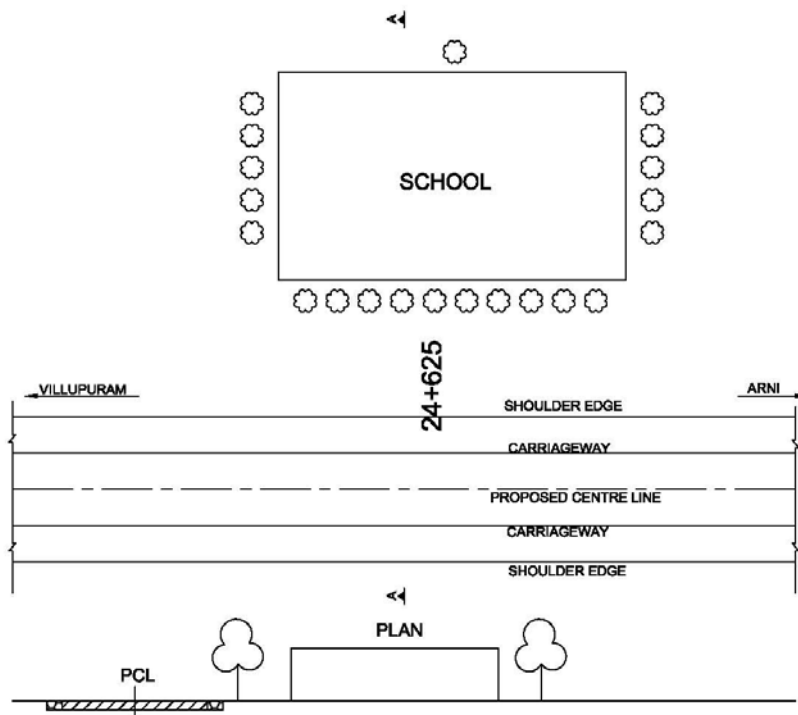

MITIGATION/ENHANCEMENT

S. No.	Description	Unit	Quantity	Rate (Rs.)	Amount (Rs.)	BOQ Item No.	
1	Tree Plantation	rm	21			2.1	
2	Horn prohibited sign post	Considered in engineering works					
Total							

Chainage (km)	29+500	
Structure ID No	School	
Village Name	Arni	
Side (Left/Right)	Right	
Distance from PCL (m)	7	
Length x Breadth (m)	12 x 19	
Proposed ROW (Equal on either side of PCL) (m)	8	
Impact	direct impact	

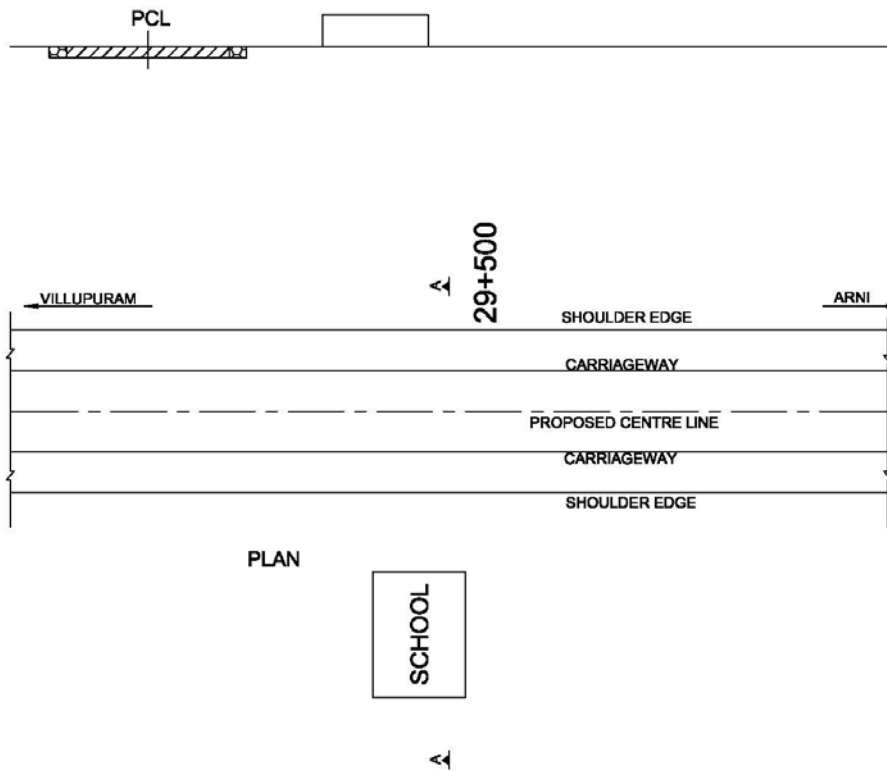

MITIGATION/ENHANCEMENT

S. No.	Description	Unit	Quantity	Rate (Rs.)	Amount (Rs.)	BOQ Item No.
1	Demolition of Structure	nil	nil	nil	nil	nil
Total					nil	

Chainage (km)	29+800	
Structure ID No	Hospital	
Village Name	Arni	
Side (Left/Right)	Right	
Distance from PCL (m)	5	
Length x Breadth (m)	13 x 35	
Proposed ROW (Equal on either side of PCL) (m)	8	
Impact	direct impact	

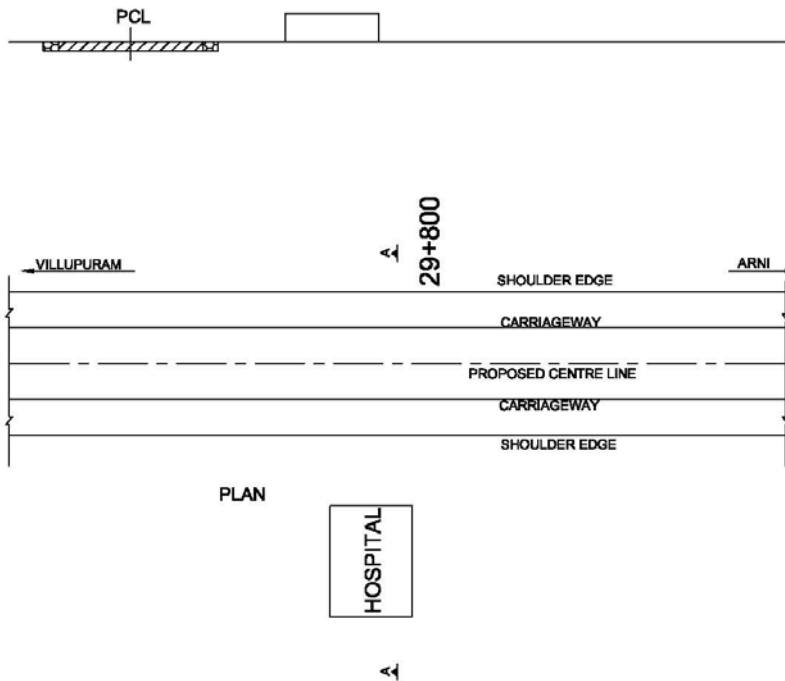

MITIGATION/ENHANCEMENT

S. No.	Description	Unit	Quantity	Rate (Rs.)	Amount (Rs.)	BOQ Item No.
1	Demolition of Structure	nil	nil	nil	nil	nil
Total					nil	

Chainage (km)	29+900	
Structure ID No	School	
Village Name	Arni	
Side (Left/Right)	Left	
Distance from PCL (m)	10.5	
Length x Breadth (m)	9 x 7	
Proposed ROW (Equal on either side of PCL) (m)	8	
Impact	No direct impact	

<4

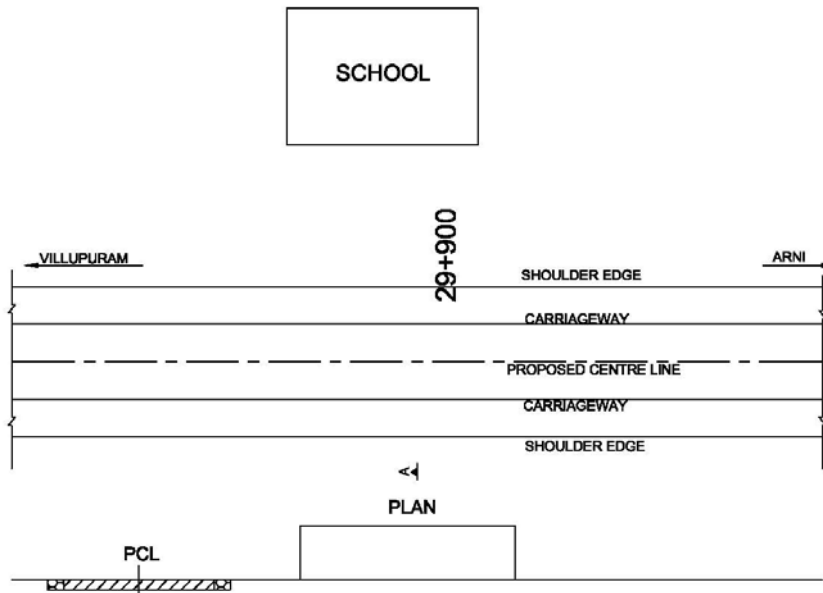

MITIGATION/ENHANCEMENT

S. No.	Description	Unit	Quantity	Rate (Rs.)	Amount (Rs.)	BOQ Item No.
1	Horn prohibited sign post				Considered in engineering works	
Total						

Chainage (km)	30+600	
Structure ID No	School	
Village Name	Arni	
Side (Left/Right)	Left	
Distance from PCL (m)	6	
Length x Breadth (m)	24 x 46	
Proposed ROW (Equal on either side of PCL) (m)	11.5	
Impact	direct impact	

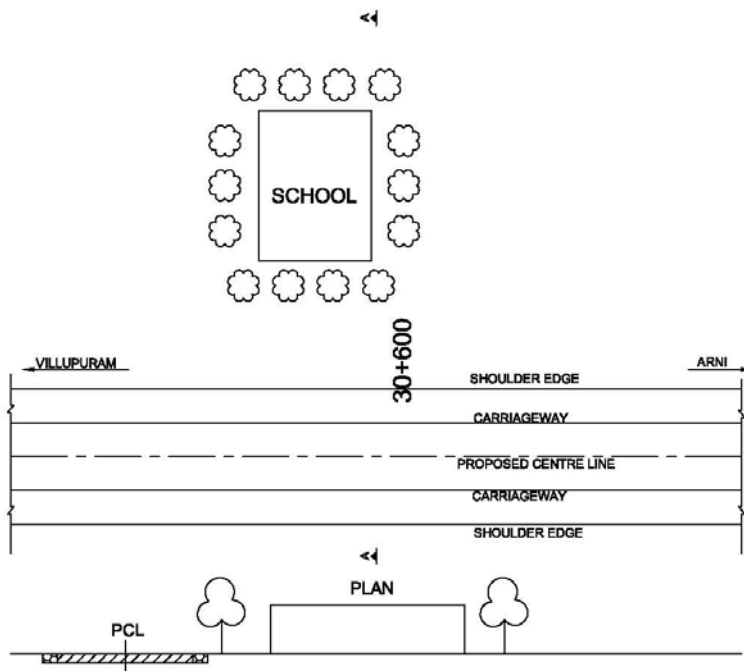

MITIGATION/ENHANCEMENT

S. No.	Description	Unit	Quantity	Rate (Rs.)	Amount (Rs.)	BOQ Item No.	
1	Demolition of Boundary Wall	rm	35			6.0	
2	Construction of Boundary Wall	rm	24			6.0	
3	Gate	no	1				
4	Tree Plantation	no	14			2.1	
5	Horn prohibited sign post	Considered in engineering works					
Total							

Chainage (km)	30+600	
Structure ID No	School	
Village Name	Arni	
Side (Left/Right)	Left	
Distance from PCL (m)	23.5	
Length x Breadth (m)	9.5 x 10	
Proposed ROW (Equal on either side of PCL) (m)	11.5	
Impact	No direct impact	

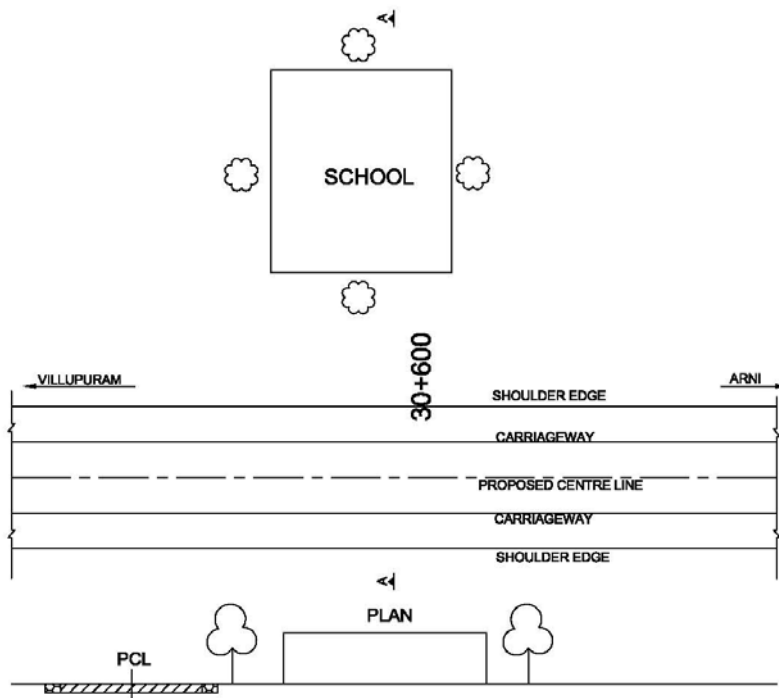

MITIGATION/ENHANCEMENT

S. No.	Description	Unit	Quantity	Rate (Rs.)	Amount (Rs.)	BOQ Item No.	
1	Tree Plantation	rm	4			2.1	
2	Horn prohibited sign post	Considered in engineering works					
Total							

Chainage (km)	31+650	
Structure ID No	School	
Village Name	Sitheri	
Side (Left/Right)	Left	
Distance from PCL (m)	27	
Length x Breadth (m)	10 x 7.5	
Proposed ROW (Equal on either side of PCL) (m)	11.5	
Impact	No direct impact	

←

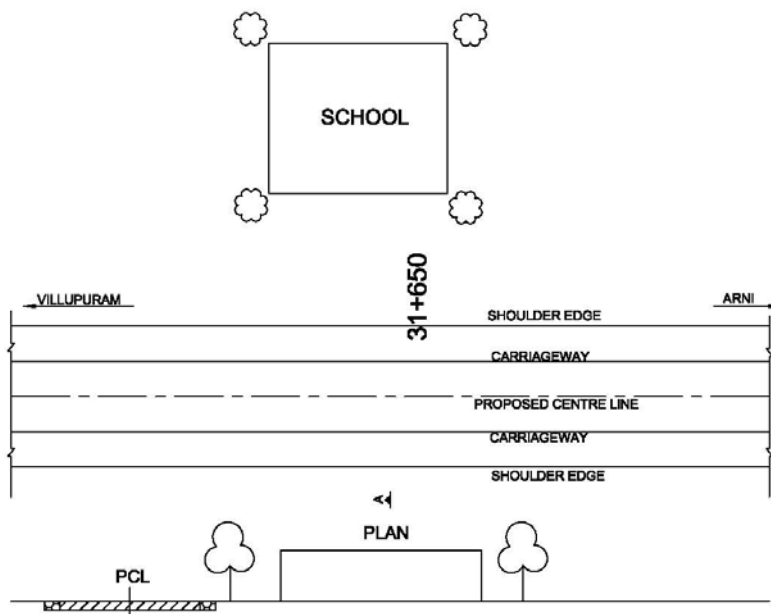

MITIGATION/ENHANCEMENT

S. No.	Description	Unit	Quantity	Rate (Rs.)	Amount (Rs.)	BOQ Item No.	
1	Tree Plantation	no	4			2.1	
2	Horn prohibited sign post	Considered in engineering works					
Total							

Chainage (km)	32+550	
Structure ID No	School	
Village Name	Nesal	
Side (Left/Right)	Right	
Distance from PCL (m)	10.5	
Length x Breadth (m)	84 x 200	
Proposed ROW (Equal on either side of PCL) (m)	8	
Impact	No direct impact	

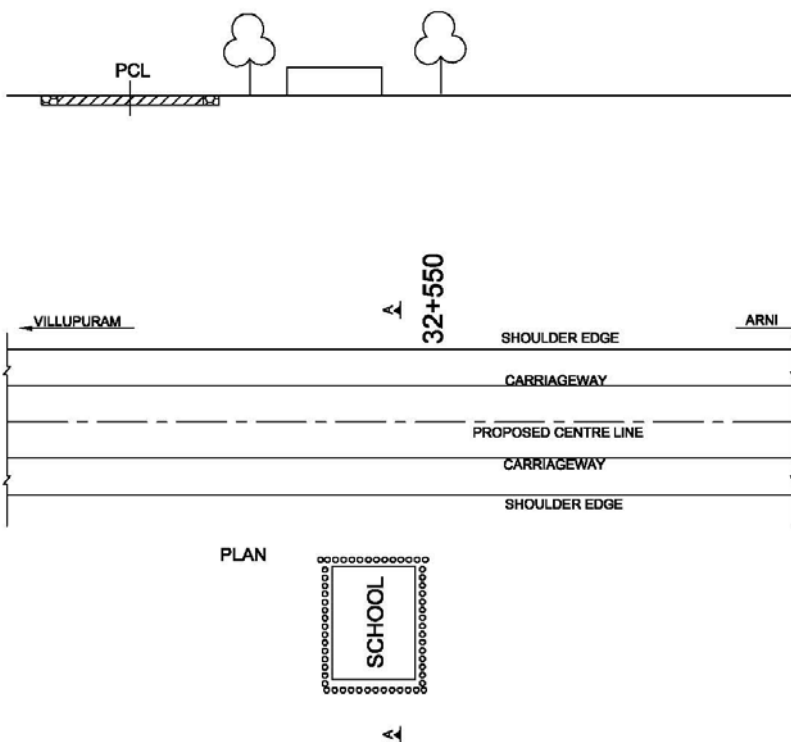

MITIGATION/ENHANCEMENT

S. No.	Description	Unit	Quantity	Rate (Rs.)	Amount (Rs.)	BOQ Item No.
1	Tree Plantation	No	57			2.1
2	Horn prohibited sign post	Considered in engineering works				
Total						

Chainage (km)	34+500	
Structure ID No	College	
Village Name	Nesal	
Side (Left/Right)	Left	
Distance from PCL (m)	16.5	
Length x Breadth (m)	130 x 70	
Proposed ROW (Equal on either side of PCL) (m)	11.5	
Impact	No direct impact	

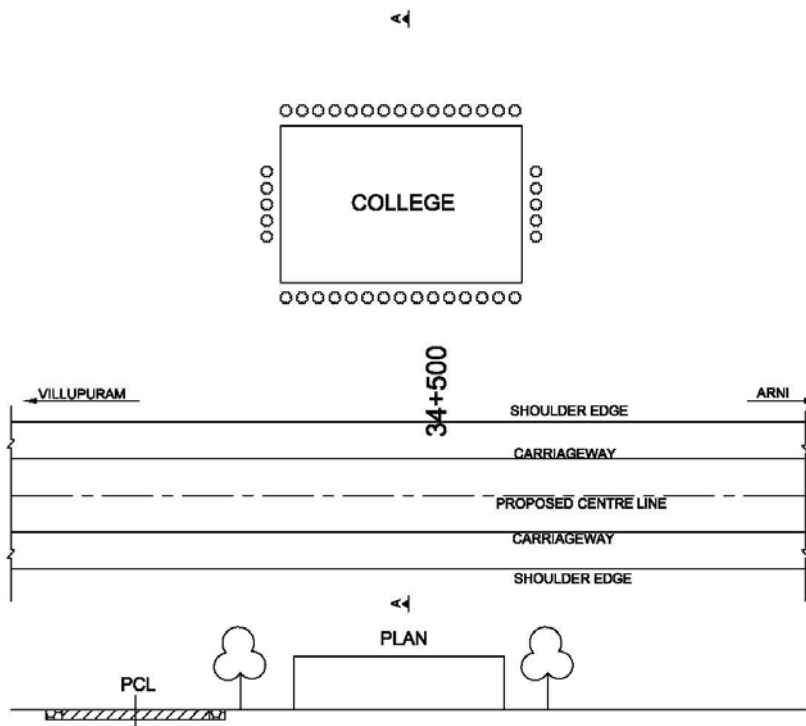

MITIGATION/ENHANCEMENT

S. No.	Description	Unit	Quantity	Rate (Rs.)	Amount (Rs.)	BOQ Item No.	
1	Tree Plantation	No	40			2.1	
2	Horn prohibited sign post	Considered in engineering works					
Total							

Chainage (km)	35+400	
Structure ID No	School	
Village Name	Nesal	
Side (Left/Right)	Left	
Distance from PCL (m)	26	
Length x Breadth (m)	142 x 160	
Proposed ROW (Equal on either side of PCL) (m)	11.5	
Impact	No direct impact	

◀

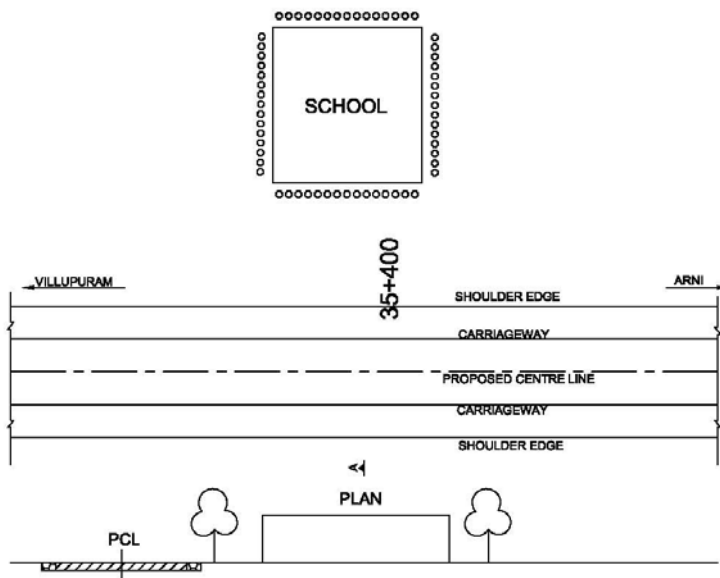

MITIGATION/ENHANCEMENT

S. No.	Description	Unit	Quantity	Rate (Rs.)	Amount (Rs.)	BOQ Item No.	
1	Tree Plantation	No	60			2.1	
2	Horn prohibited sign post	Considered in engineering works					
				Total			

Chainage (km)	37+600
Structure ID No	Hospital
Village Name	Vinnamangal
Side (Left/Right)	Left
Distance from PCL (m)	10.5
Length x Breadth (m)	8.5 x 7.5
Proposed ROW (Equal on either side of PCL) (m)	8
Impact	No direct impact

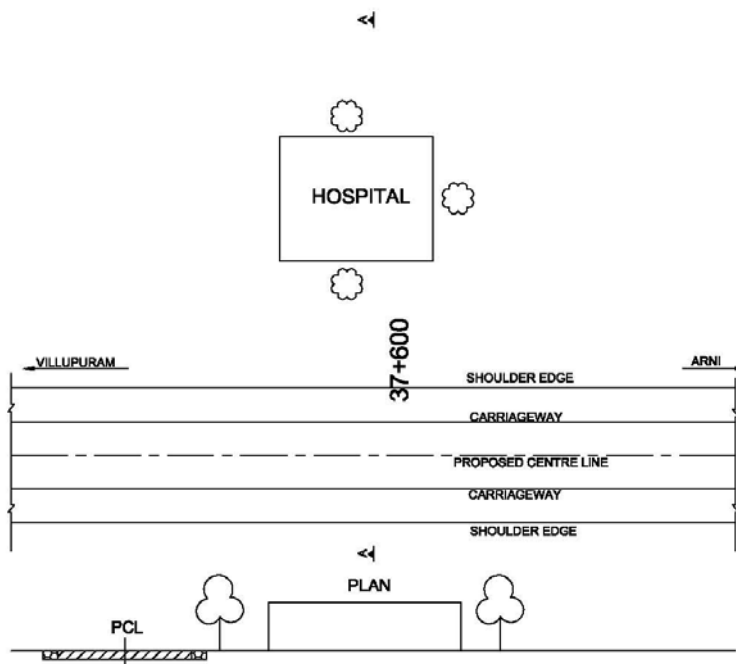

MITIGATION/ENHANCEMENT

S. No.	Description	Unit	Quantity	Rate (Rs.)	Amount (Rs.)	BOQ Item No.	
1	Tree Plantation	No	3			2.1	
2	Horn prohibited sign post	Considered in engineering works					
				Total			

Chainage (km)	37+575	
Structure ID No	School.	
Village Name	Vinnamangal	
Side (Left/Right)	Right	
Distance from PCL (m)	7	
Length x Breadth (m)	36.5 x 32	
Proposed ROW (Equal on either side of PCL) (m)	11.5	
Impact	direct impact	

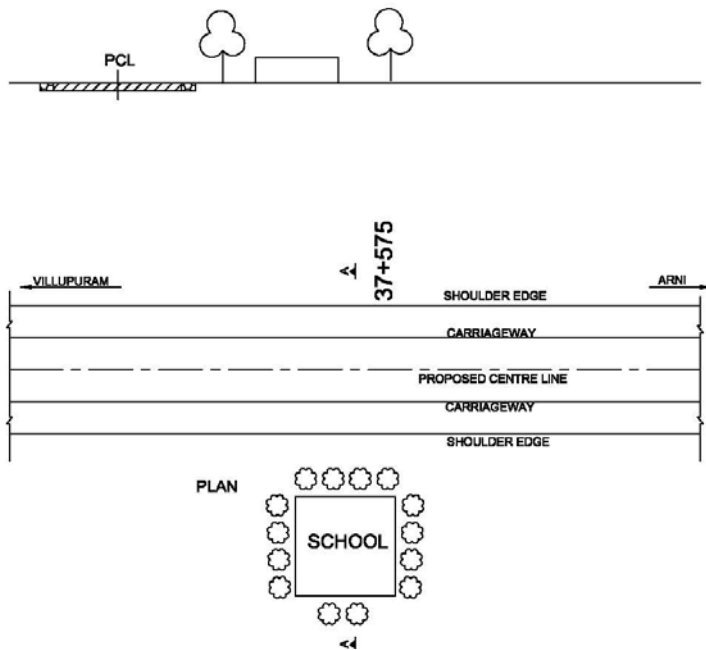

MITIGATION/ENHANCEMENT

S. No.	Description	Unit	Quantity	Rate (Rs.)	Amount (Rs.)	BOQ Item No.	
1	Demolition of Boundary Wall	rm	47			6.0	
2	Construction of Boundary Wall	rm	36.5			6.0	
3	Gate	no	1				
4	Tree Plantation	no	14			2.1	
5	Horn prohibited sign post	Considered in engineering works					
Total							

Chainage (km)	43+400	
Structure ID No	School	
Village Name	Kollappalur	
Side (Left/Right)	Right	
Distance from PCL (m)	16	
Length x Breadth (m)	40 x 45	
Proposed ROW (Equal on either side of PCL) (m)	11.5	
Impact	No direct impact	

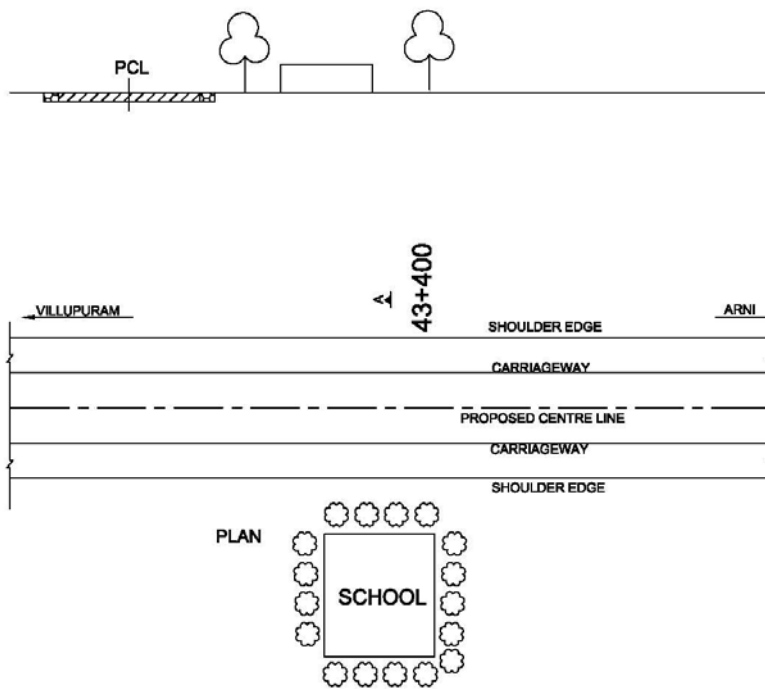

MITIGATION/ENHANCEMENT

S. No.	Description	Unit	Quantity	Rate (Rs.)	Amount (Rs.)	BOQ Item No.	
1	Tree Plantation	No	17			2.1	
2	Horn prohibited sign post	Considered in engineering works					
Total							

Chainage (km)	43+850
Structure ID No	School
Village Name	Indravarnam
Side (Left/Right)	Right
Distance from PCL (m)	26.5
Length x Breadth (m)	19.5 x 6
Proposed ROW (Equal on either side of PCL) (m)	8
Impact	No direct impact

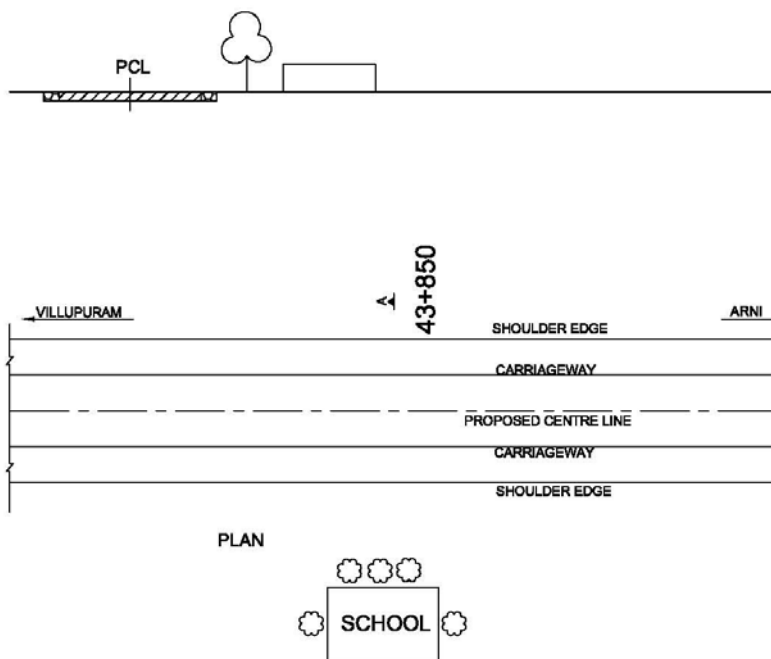

MITIGATION/ENHANCEMENT

S. No.	Description	Unit	Quantity	Rate (Rs.)	Amount (Rs.)	BOQ Item No.	
1	Construction of Boundary Wall	rm	19.5			6.0	
2	Gate	no	1				
3	Tree Plantation	no	5			2.1	
4	Horn prohibited sign post	Considered in engineering works					
Total							

Chainage (km)	43+900
Structure ID No	School
Village Name	Indravarnam
Side (Left/Right)	Left
Distance from PCL (m)	7
Length x Breadth (m)	15 x 11
Proposed ROW (Equal on either side of PCL) (m)	8
Impact	direct impact

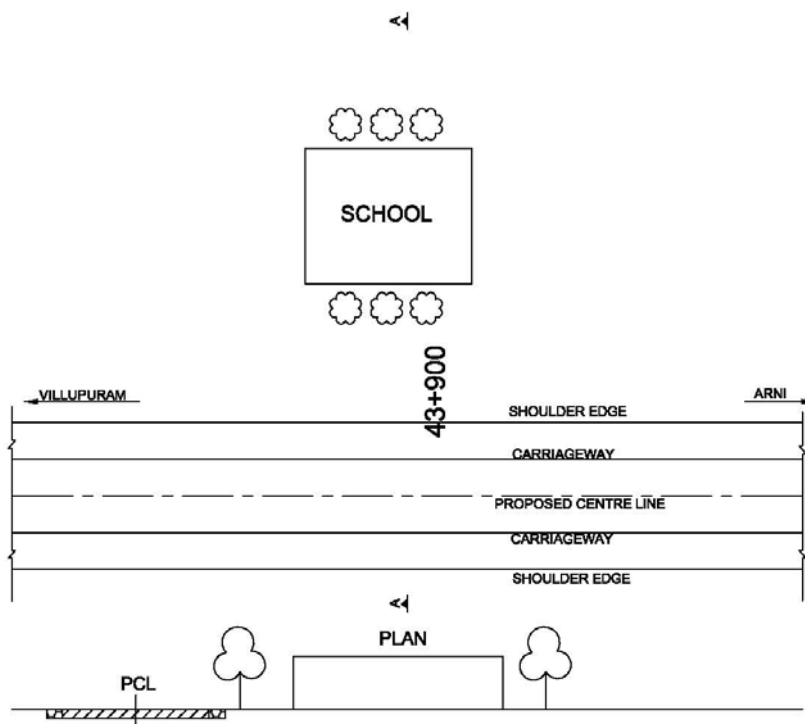

MITIGATION/ENHANCEMENT

S. No.	Description	Unit	Quantity	Rate (Rs.)	Amount (Rs.)	BOQ Item No.	
1	Demolition of Boundary Wall	rm	18			6.0	
2	Construction of Boundary Wall	rm	15			6.0	
3	Gate	no	1				
4	Tree Plantation	no	6			2.1	
5	Horn prohibited sign post	Considered in engineering works					
Total							

Chainage (km)	53+150	
Structure ID No	School	
Village Name	Chetpet	
Side (Left/Right)	Right	
Distance from PCL(m)	19.5	
Length x Breadth(m)	19.5 x 43	
Proposed ROW (Equal on either side of PCL) (m)	11.5	
Impact	No direct impact	

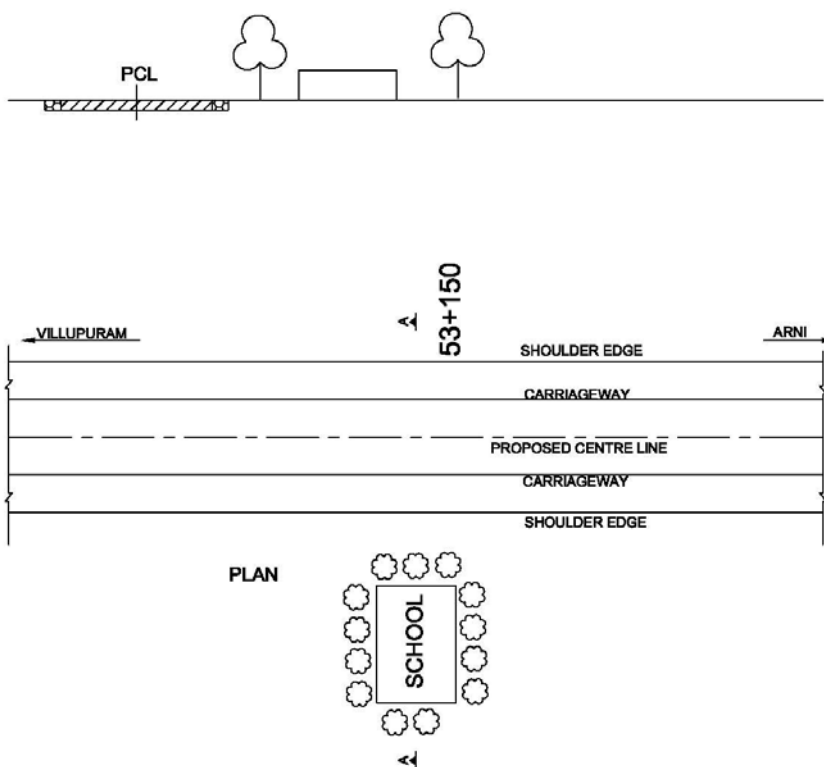

MITIGATION/ENHANCEMENT

S. No.	Description	Unit	Quantity	Rate (Rs.)	Amount (Rs.)	BOQ Item No.	
1	Tree Plantation	rm	13			2.1	
2	Horn prohibited sign post	Considered in engineering works					
Total							

Chainage (km)	53+725
Structure ID No	School
Village Name	Chetpet
Side (Left/Right)	Left
Distance from PCL(m)	17.5
Length x Breadth(m)	103 x 110
Proposed ROW (Equal on either side of PCL) (m)	11.5
Impact	No direct impact



◀

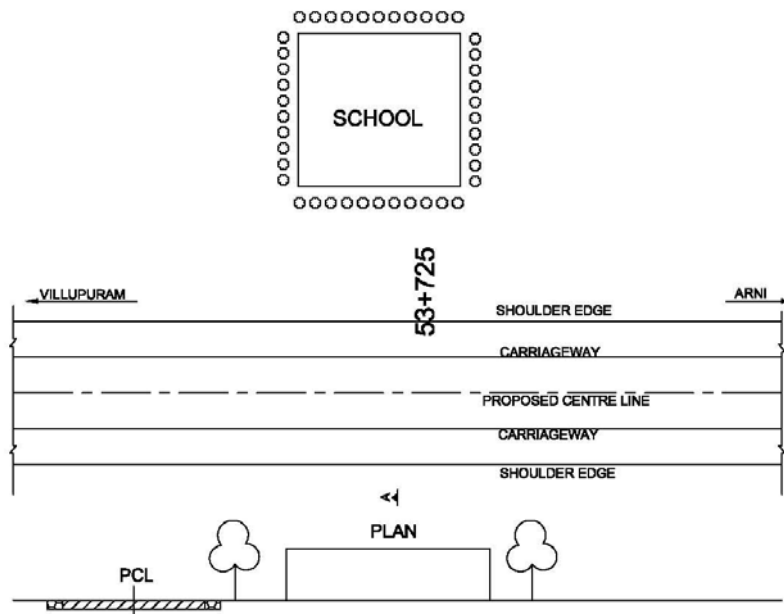

MITIGATION/ENHANCEMENT

S. No.	Description	Unit	Quantity	Rate (Rs.)	Amount (Rs.)	BOQ Item No.	
1	Tree Plantation	rm	42			2.1	
2	Horn prohibited sign post	Considered in engineering works					
				Total			

Chainage (km)	56+650	
Structure ID No	Training centre	
Village Name	Nanodayam	
Side (Left/Right)	Left	
Distance from PCL(m)	16	
Length x Breadth(m)	19.5 x 210	
Proposed ROW (Equal on either side of PCL) (m)	11.5	
Impact	No direct impact	

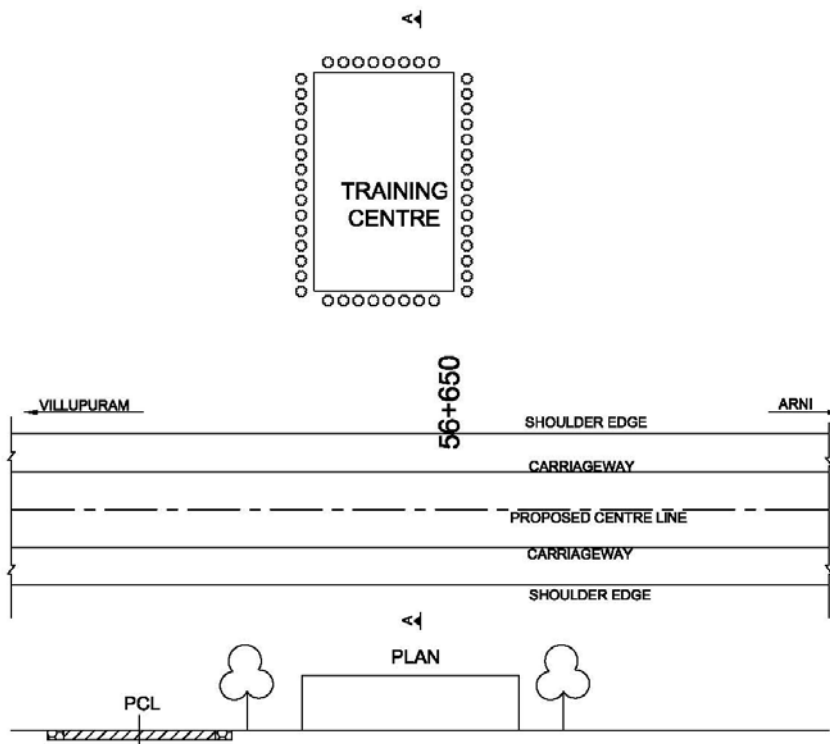

MITIGATION/ENHANCEMENT

S. No.	Description	Unit	Quantity	Rate (Rs.)	Amount (Rs.)	BOQ Item No.
1	Existing boundary wall will be raised and develop as noise barrier	rm	19.5			6.0
2	Tree Plantation	no	46			2.1
3	Horn prohibited sign post	Considered in engineering works				
				Total		

Chainage (km)	63+750	
Structure ID No	Hostel	
Village Name	Valathy	
Side (Left/Right)	Right	
Distance from PCL(m)	45.5	
Length x Breadth(m)	42 x 14	
Proposed ROW (Equal on either side of PCL) (m)	11.5	
Impact	direct impact	

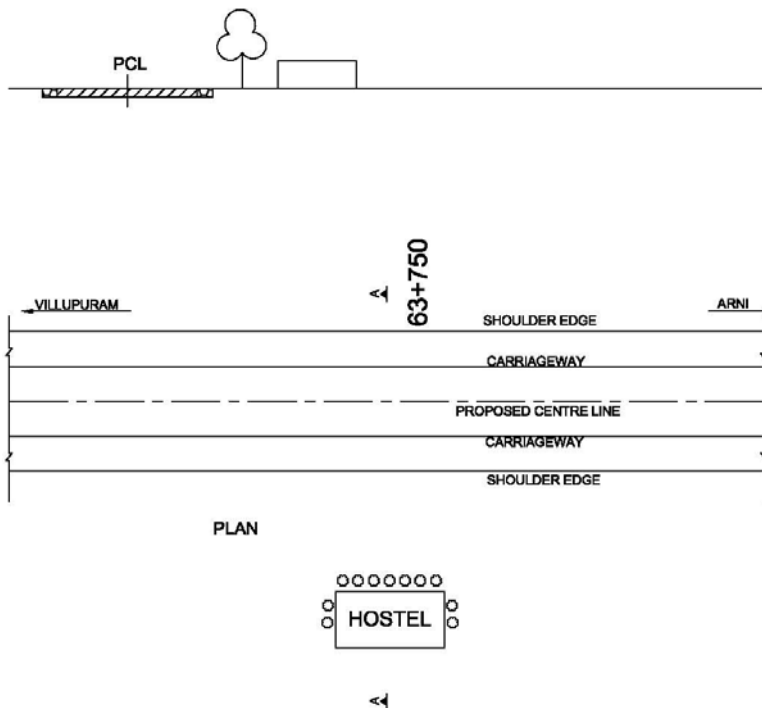

MITIGATION/ENHANCEMENT

S. No.	Description	Unit	Quantity	Rate (Rs.)	Amount (Rs.)	BOQ Item No.	
1	Tree Plantation	No	11			2.1	
2	Horn prohibited sign post	Considered in engineering works					
Total							

Chainage (km)	63+950	
Structure ID No	School	
Village Name	Valathy	
Side (Left/Right)	Left	
Distance from PCL(m)	11	
Length x Breadth(m)	266 x 38	
Proposed ROW (Equal on either side of PCL) (m)	11.5	
Impact	direct impact	

←

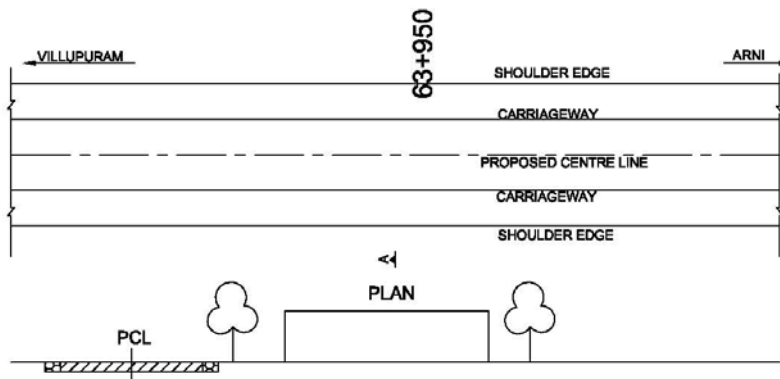

MITIGATION/ENHANCEMENT

S. No.	Description	Unit	Quantity	Rate (Rs.)	Amount (Rs.)	BOQ Item No.	
1	Demolition of Boundary Wall	rm	267			6.0	
2	Construction of Boundary Wall	rm	266			6.0	
3	Gate	no	1				
4	Tree Plantation	no	61			2.1	
5	Horn prohibited sign post	Considered in engineering works					
Total							

Chainage (km)	64+300
Structure ID No	Veterinary hospital
Village Name	Valathy
Side (Left/Right)	Right
Distance from PCL(m)	12
Length x Breadth(m)	85 x 29
Proposed ROW (Equal on either side of PCL) (m)	11.5
Impact	No direct impact

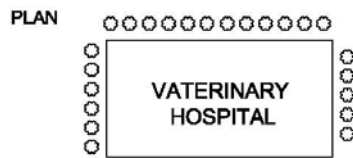
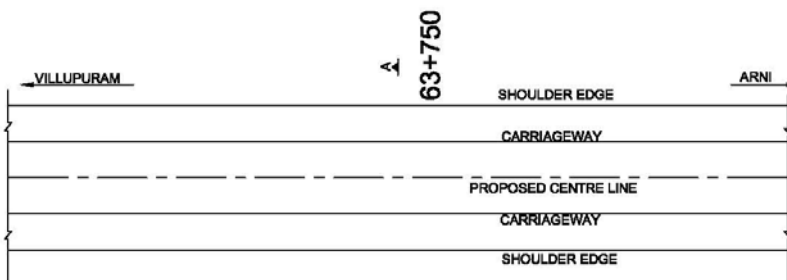

MITIGATION/ENHANCEMENT

S. No.	Description	Unit	Quantity	Rate (Rs.)	Amount (Rs.)	BOQ Item No.
1	Tree Plantation	No	23			2.1
2	Horn prohibited sign post	Considered in engineering works				
Total						

Chainage (km)	72+400	
Structure ID No	School	
Village Name	Neelampoondi	
Side (Left/Right)	Right	
Distance from PCL(m)	42	
Length x Breadth(m)	70 x 18	
Proposed ROW (Equal on either side of PCL) (m)	11.5	
Impact	No direct impact	

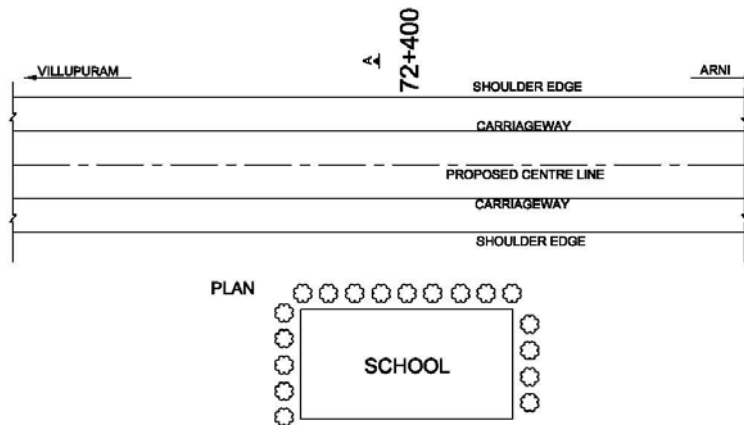

MITIGATION/ENHANCEMENT

S. No.	Description	Unit	Quantity	Rate (Rs.)	Amount (Rs.)	BOQ Item No.
1	Tree Plantation	No	18			2.1
2	Horn prohibited sign post	Considered in engineering works				
Total						

Chainage (km)	74+425	
Structure ID No	School	
Village Name	Chellabadai	
Side (Left/Right)	Right	
Distance from PCL (m)	17.5	
Length x Breadth (m)	100 x 65	
Proposed ROW (Equal on either side of PCL) (m)	11.5	
Impact	No direct impact	

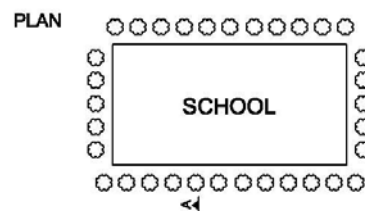
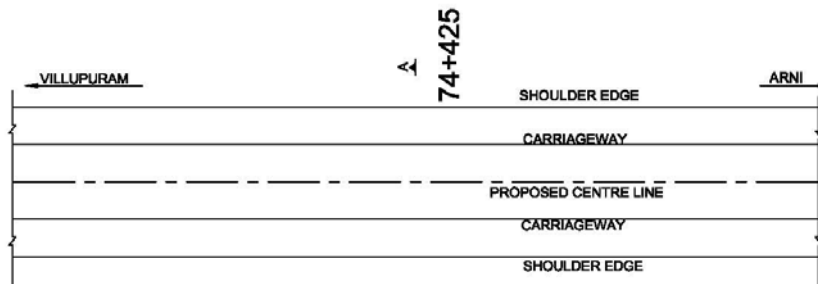
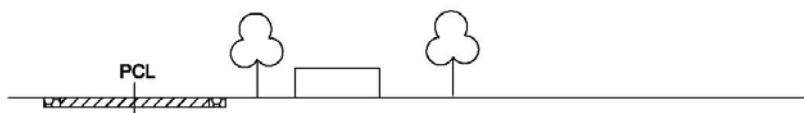

MITIGATION/ENHANCEMENT

S. No.	Description	Unit	Quantity	Rate (Rs.)	Amount (Rs.)	BOQ Item No.	
1	Tree Plantation	No	33			2.1	
2	Horn prohibited sign post	Considered in engineering works					
				Total			

Chainage (km)	80+900
Structure ID No	School
Village Name	Gingee
Side (Left/Right)	Left
Distance from PCL(m)	9.5
Length x Breadth(m)	44.5 x 49
Proposed ROW (Equal on either side of PCL) (m)	8
Impact	No direct impact

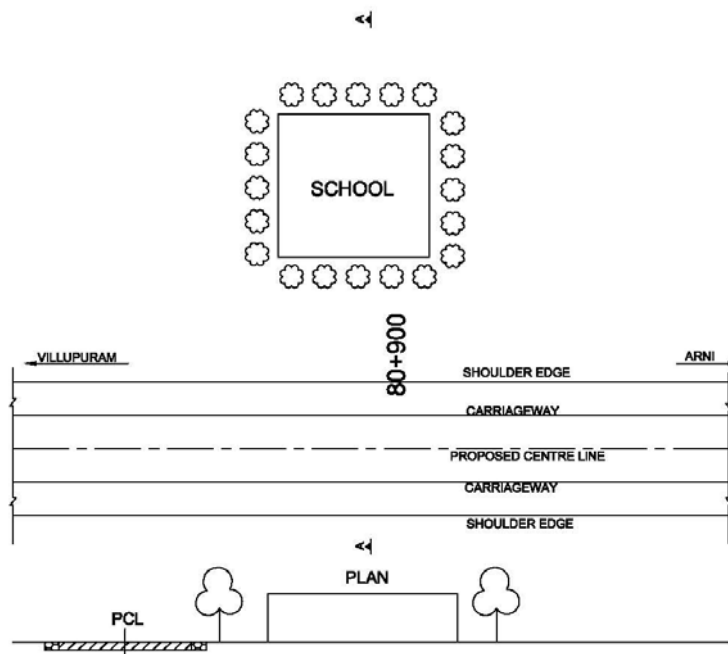

MITIGATION/ENHANCEMENT

S. No.	Description	Unit	Quantity	Rate (Rs.)	Amount (Rs.)	BOQ Item No.
1	Tree Plantation	No	19			2.1
2	Horn prohibited sign post	Considered in engineering works				
				Total		

Chainage (km)	79+700	
Structure ID No	Hospital	
Village Name	Gingee	
Side (Left/Right)	Right	
Distance from PCL(m)	16.5	
Length x Breadth(m)	145 x 50	
Proposed ROW (Equal on either side of PCL) (m)	8	
Impact	No direct impact	

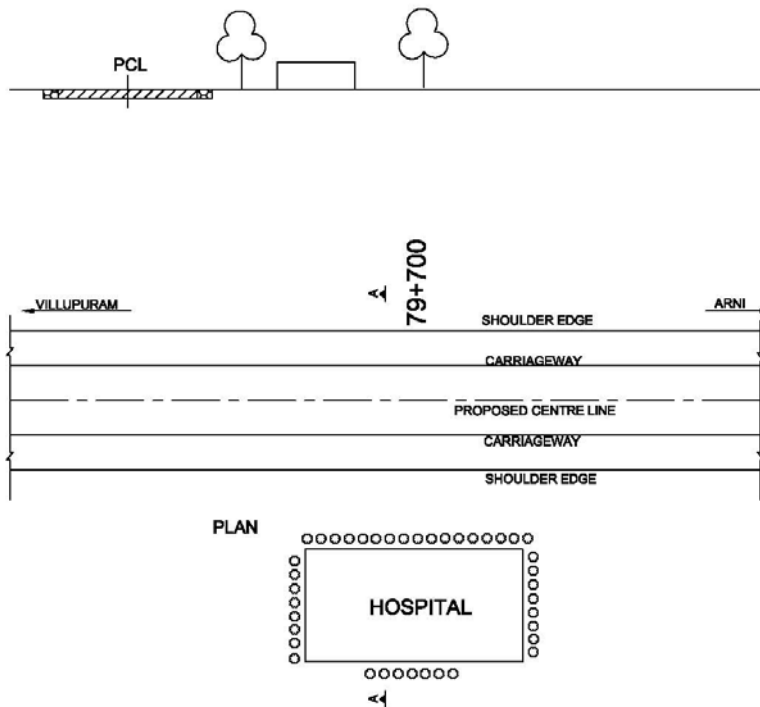

MITIGATION/ENHANCEMENT

S. No.	Description	Unit	Quantity	Rate (Rs.)	Amount (Rs.)	BOQ Item No.
1	Tree Plantation	No	40			2.1
2	Horn prohibited sign post	Considered in engineering works				
Total						

Chainage (km)	86+510	
Structure ID No	School	
Village Name	Sitampoondi	
Side (Left/Right)	Right	
Distance from PCL (m)	13.5	
Leth x Breadth (m)	50 x 35	
Proposed ROW (Equal on either side of PCL) (m)	11.5	
Impact	No direct impact	

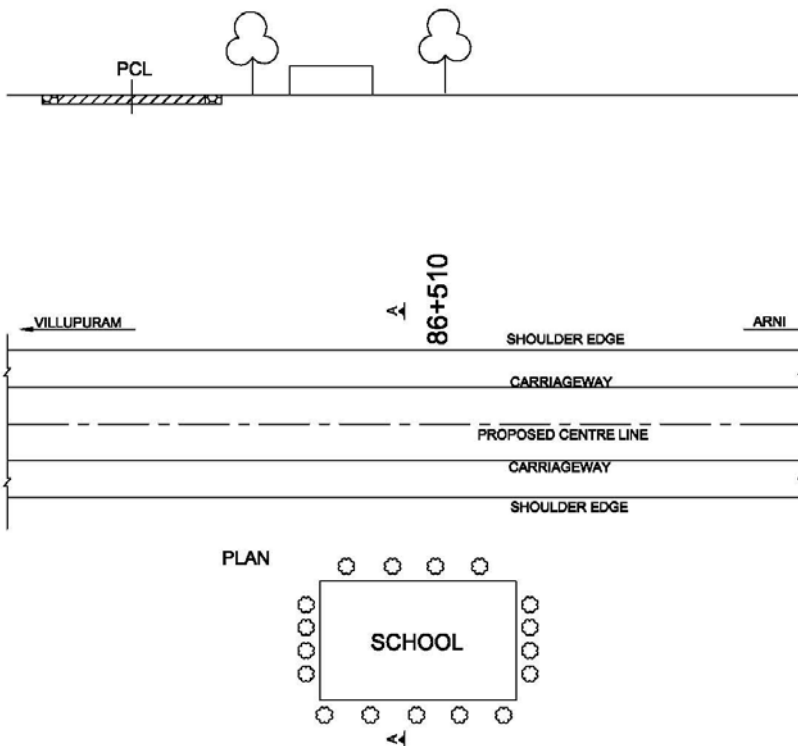

MITIGATION/ENHANCEMENT

S. No.	Description	Unit	Quantity	Rate (Rs.)	Amount (Rs.)	BOQ Item No.
1	Tree Plantation	No	17			2.1
2	Horn prohibited sign post	Considered in engineering works				
Total						

Chainage (km)	86+834	
Structure ID No	Training centre	
Village Name	Sitampondi	
Side (Left/Right)	Left	
Distance from PCL (m)	19	
Length x Breadth (m)	22.5 x 51	
Proposed ROW (Equal on either side of PCL) (m)	11.5	
Impact	No direct impact	

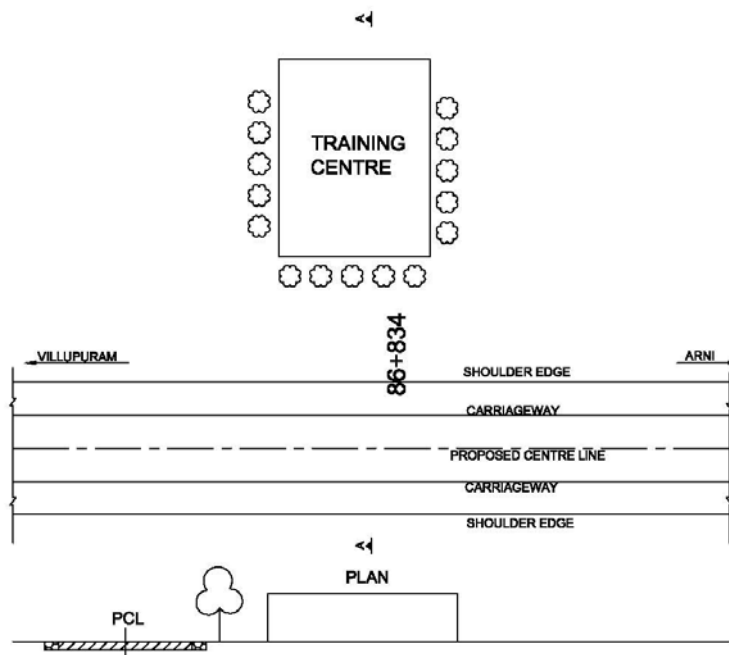

MITIGATION/ENHANCEMENT

S. No.	Description	Unit	Quantity	Rate (Rs.)	Amount (Rs.)	BOQ Item No.	
1	Tree Plantation	No	15			2.1	
2	Horn prohibited sign post	Considered in engineering works					
Total							

Chainage (km)	90+750
Structure ID No	School
Village Name	Ottampattu
Side (Left/Right)	Right
Distance from PCL (m)	10
Length x Breadth (m)	13 x 38
Proposed ROW (Equal on either side of PCL) (m)	11.5
Impact	direct impact

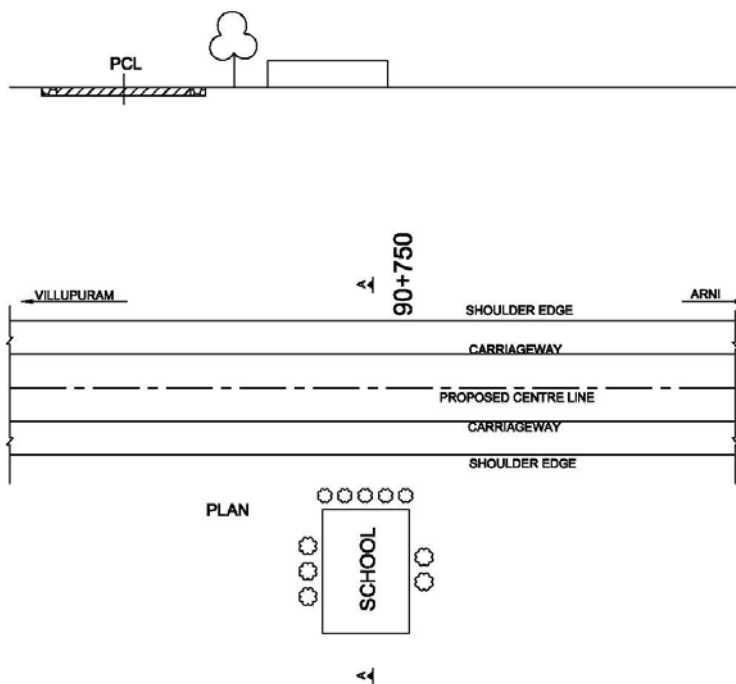

MITIGATION/ENHANCEMENT

S. No.	Description	Unit	Quantity	Rate (Rs.)	Amount (Rs.)	BOQ Item No.	
1	Demolition of Boundary Wall	rm	16			6.0	
2	Construction of Boundary Wall	rm	13			6.0	
3	Gate	no	1				
4	Tree Plantation	no	10			2.1	
5	Horn prohibited sign post	Considered in engineering works					
				Total			

Chainage (km)	95+800	
Structure ID No	School	
Village Name	Muttathur	
Side (Left/Right)	Left	
Distance from PCL (m)	45	
Length x Breadth (m)	42 x 70	
Proposed ROW (Equal on either side of PCL) (m)	11.5	
Impact	No direct impact	

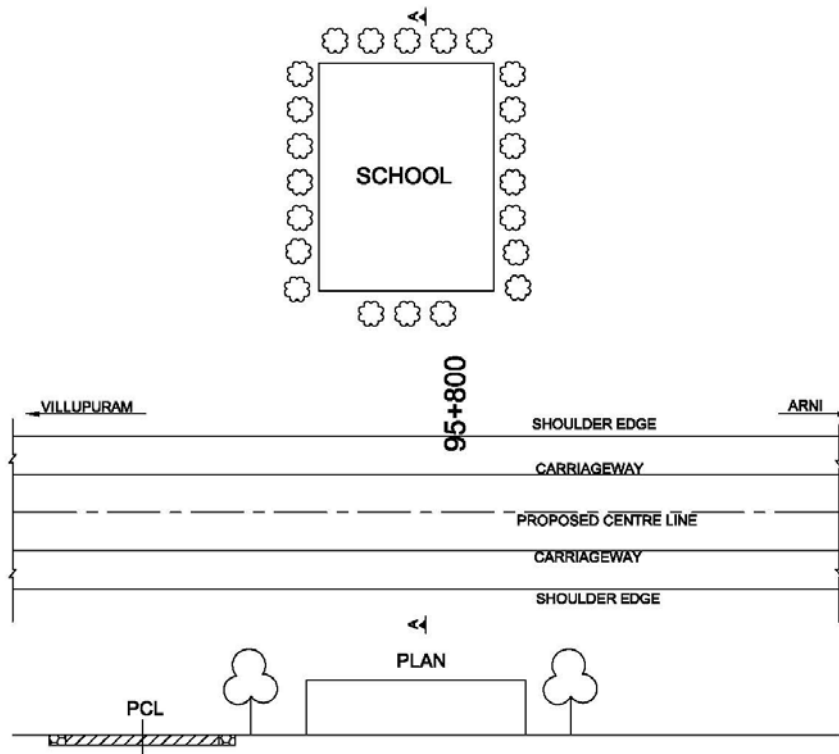

MITIGATION/ENHANCEMENT

S. No.	Description	Unit	Quantity	Rate (Rs.)	Amount (Rs.)	BOQ Item No.	
1	Tree Plantation	No	22			2.1	
2	Horn prohibited sign post	Considered in engineering works					
Total							

Chainage (km)	95+800
Structure ID No	Hostel
Village Name	Muttathur
Side (Left/Right)	Right
Distance from PCL (m)	45
Length x Breadth (m)	30 x 50
Proposed ROW (Equal on either side of PCL) (m)	11.5
Impact	No direct impact

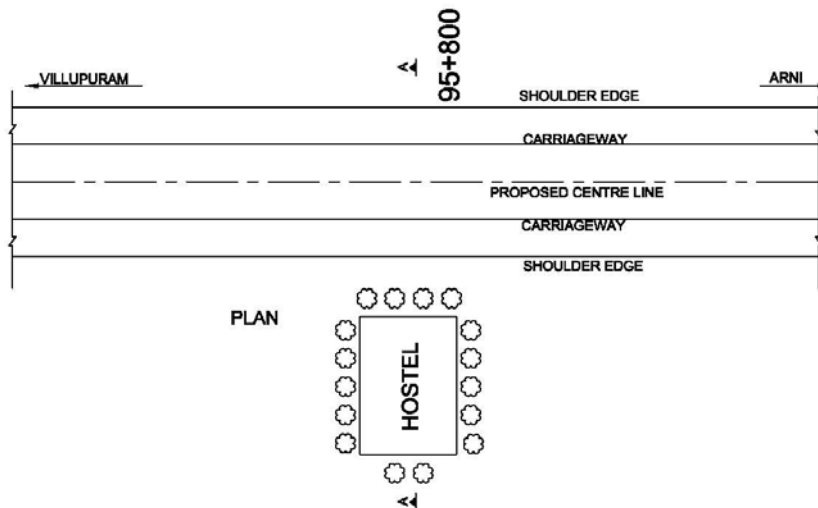
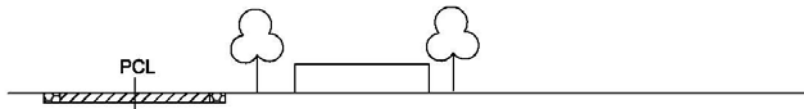

MITIGATION/ENHANCEMENT

S. No.	Description	Unit	Quantity	Rate (Rs.)	Amount (Rs.)	BOQ Item No.
1	Tree Plantation	No	16			2.1
2	Horn prohibited sign post	Considered in engineering works				
				Total		

Chainage (km)	95+800	
Structure ID No	Church +school+hospital	
Village Name	Muttathur	
Side (Left/Right)	Left	
Distance from PCL (m)	15.5	
Length x Breadth (m)	154 x 210	
Proposed ROW (Equal on either side of PCL) (m)	11.5	
Impact	No direct impact	

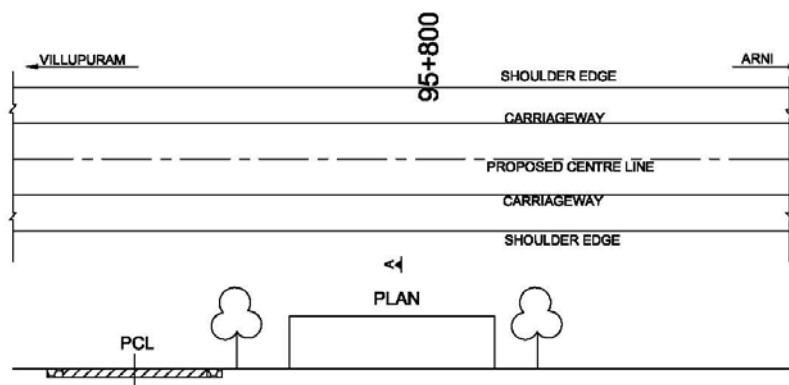
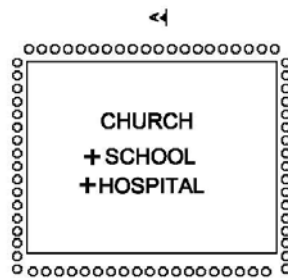

MITIGATION/ENHANCEMENT

S. No.	Description	Unit	Quantity	Rate (Rs.)	Amount (Rs.)	BOQ Item No.	
1	Tree Plantation	No	73			2.1	
2	Horn prohibited sign post	Considered in engineering works					
Total							

Chainage (km)	99+850	
Structure ID No	School	
Village Name	Nandivadi	
Side (Left/Right)	Left	
Distance from PCL (m)	16.5	
Length x Breadth (m)	65 x 52	
Proposed ROW (Equal on either side of PCL) (m)	11.5	
Impact	No direct impact	

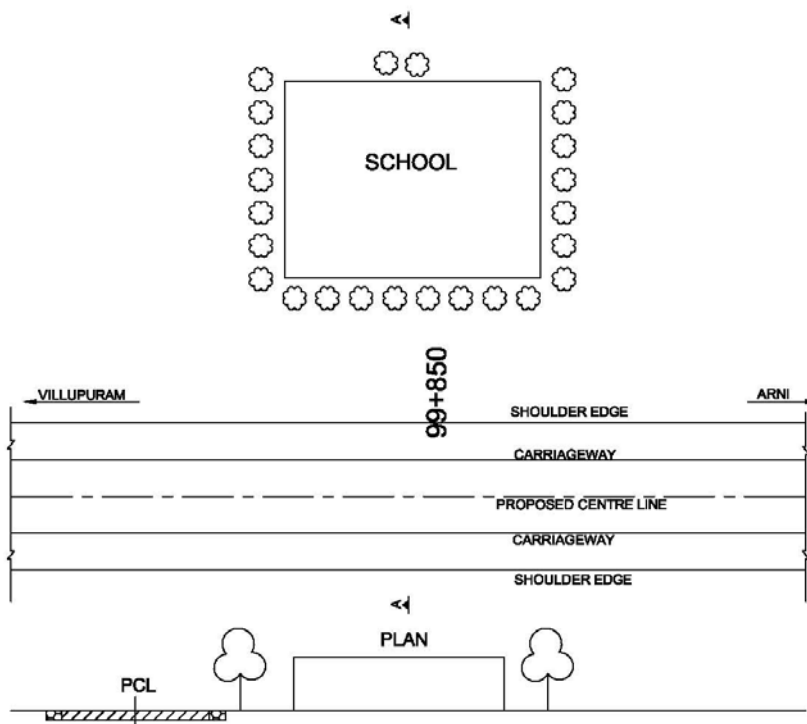

MITIGATION/ENHANCEMENT

S. No.	Description	Unit	Quantity	Rate (Rs.)	Amount (Rs.)	BOQ Item No.	
1	Construction of Boundary Wall	rm	65			6.0	
2	Tree Plantation	no	24			2.1	
3	Gate	no	1				
4	Horn prohibited sign post	Considered in engineering works					
				Total			

Chainage (km)	101+075	
Structure ID No	ITI	
Village Name	Narsinganur	
Side (Left/Right)	Right	
Distance from PCL (m)	15.5	
Length x Breadth (m)	75 x 140	
Proposed ROW (Equal on either side of PCL) (m)	8	
Impact	No direct impact	

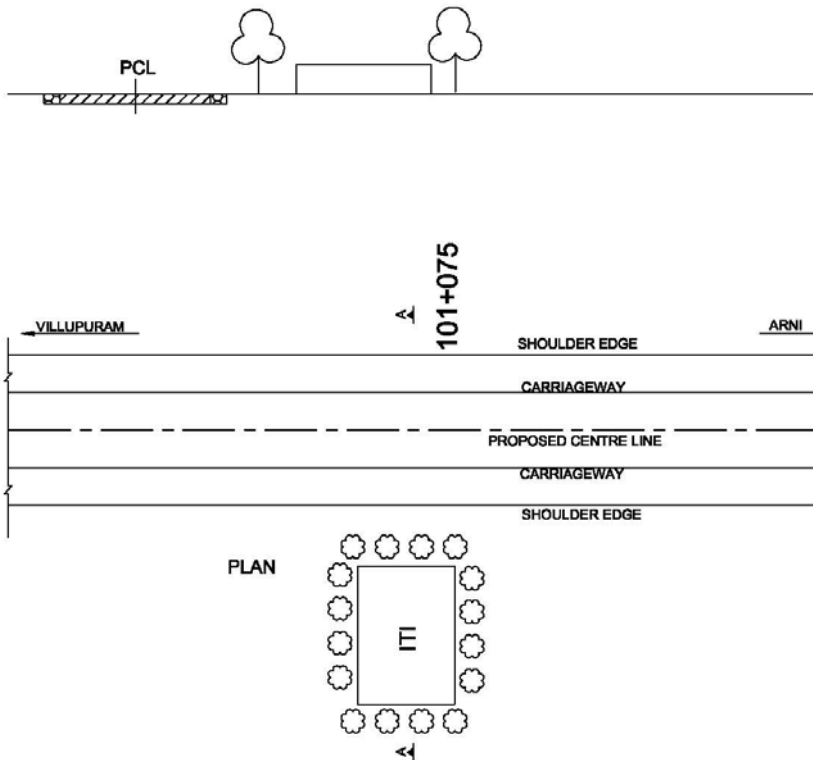

MITIGATION/ENHANCEMENT

S. No.	Description	Unit	Quantity	Rate (Rs.)	Amount (Rs.)	BOQ Item No.	
1	Construction of Boundary Wall	rm	75			6.0	
2	Gate	no	1				
3	Tree Plantation	no	140			2.1	
4	Horn prohibited sign post	Considered in engineering works					
Total							

Chainage (km)	101+490	
Structure ID No	School	
Village Name	Narsinganur	
Side (Left/Right)	Left	
Distance from PCL (m)	15.5	
Length x Breadth (m)	56 x 14	
Proposed ROW (Equal on either side of PCL) (m)	8	
Impact	No direct impact	

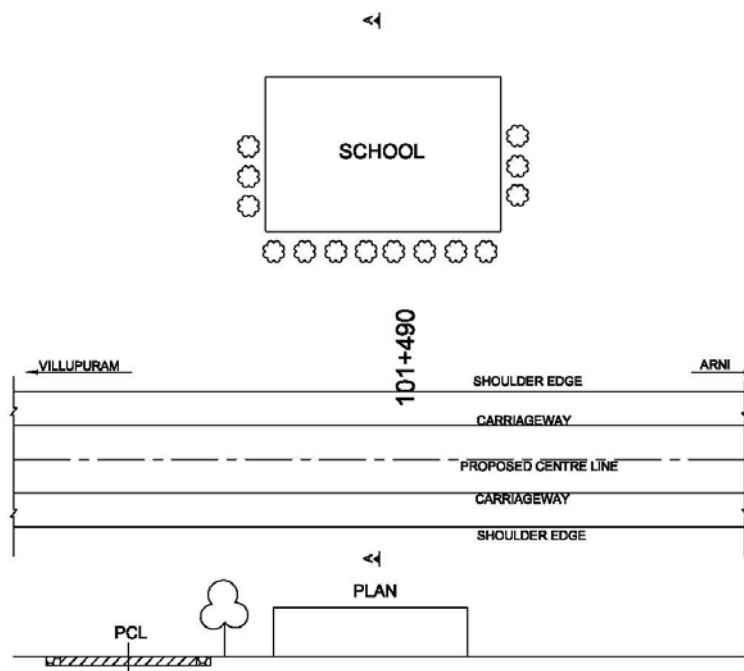

MITIGATION/ENHANCEMENT

S. No.	Description	Unit	Quantity	Rate (Rs.)	Amount (Rs.)	BOQ Item No.	
1	Construction of Boundary Wall	rm	56			6.0	
2	Tree Plantation	no	14			2.1	
3	Gate	no	1			6.0	
4	Horn prohibited sign post	Considered in engineering works					
Total							

Chainage (km)	102+900	
Structure ID No	Hospital	
Village Name	Kanjanur	
Side (Left/Right)	Right	
Distance from PCL (m)	13.5	
Length x Breadth (m)	82 x 35	
Proposed ROW (Equal on either side of PCL) (m)	8	
Impact	No direct impact	

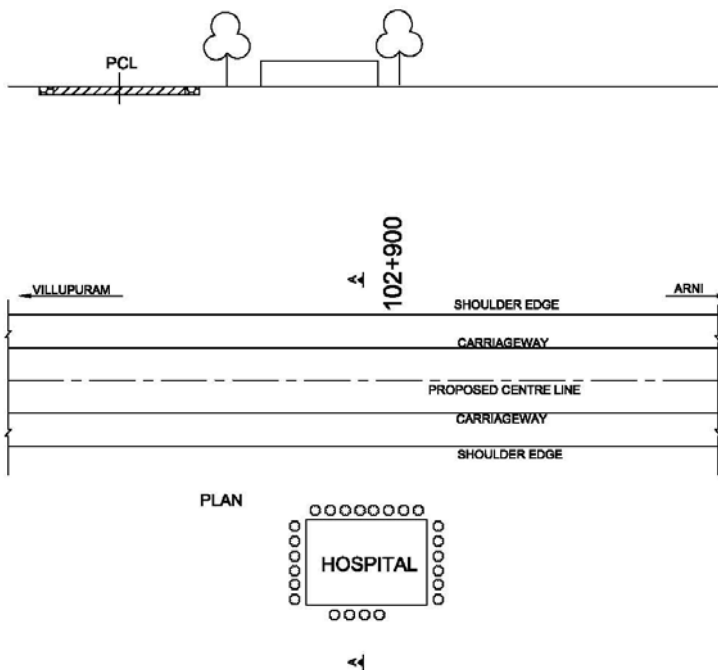

MITIGATION/ENHANCEMENT

S. No.	Description	Unit	Quantity	Rate (Rs.)	Amount (Rs.)	BOQ Item No.	
1	Construction of Boundary Wall	rm	82			6.0	
2	Tree Plantation	no	24			2.1	
3	Gate	no	1			6.0	
4	Horn prohibited sign post	Considered in engineering works					
Total							

Chainage (km)	106+300	
Structure ID No	School	
Village Name	Ashokpuri	
Side (Left/Right)	Left	
Distance from PCL (m)	36	
Length x Breadth (m)	10.5 x 6.5	
Proposed ROW (Equal on either side of PCL) (m)	11.5	
Impact	No direct impact	

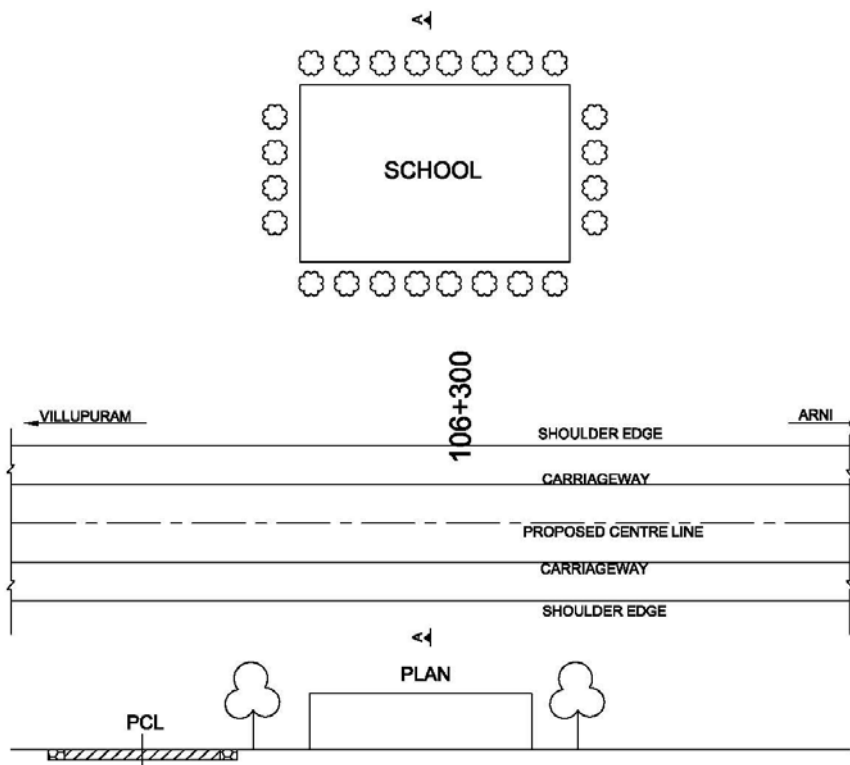

MITIGATION/ENHANCEMENT

S. No.	Description	Unit	Quantity	Rate (Rs.)	Amount (Rs.)	BOQ Item No.	
1	Construction of Boundary Wall	rm	82			6.0	
2	Tree Plantation	no	24			2.1	
3	Gate	no	1			6.0	
4	Horn prohibited sign post	Considered in engineering works					
Total							

Chainage (km)	106+350	
Structure ID No	School	
Village Name	Ashokpuri	
Side (Left/Right)	Left	
Distance from PCL (m)	20	
Length x Breadth (m)	13.5 x 7	
Proposed ROW (Equal on either side of PCL) (m)	11.5	
Impact	No direct impact	

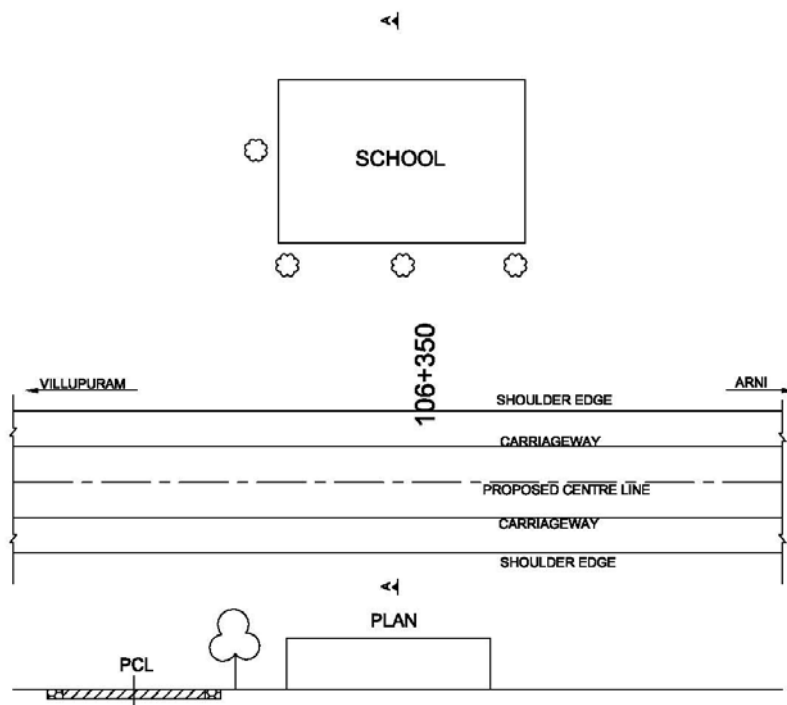

MITIGATION/ENHANCEMENT

S. No.	Description	Unit	Quantity	Rate (Rs.)	Amount (Rs.)	BOQ Item No.	
1	Construction of Boundary Wall	rm	13.5			6.0	
2	Tree Plantation	no	4			2.1	
3	Gate	no	1			6.0	
4	Horn prohibited sign post	Considered in engineering works					
Total							

Chainage (km)	107+150	
Structure ID No	School	
Village Name	Thumbur	
Side (Left/Right)	Left	
Distance from PCL (m)	7	
Length x Breadth (m)	104.2 x 44.8	
Proposed ROW (Equal on either side of PCL) (m)	8	
Impact	direct impact	

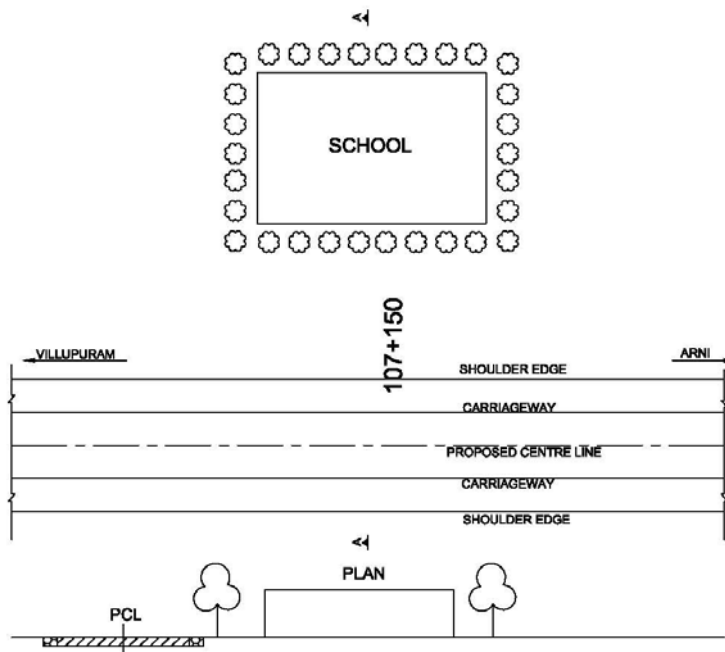

MITIGATION/ENHANCEMENT

S. No.	Description	Unit	Quantity	Rate (Rs.)	Amount (Rs.)	BOQ Item No.	
1	Demolition of Boundary Wall	rm	108			6.0	
2	Construction of Boundary Wall	rm	104.2			6.0	
3	Tree Plantation	no	30			2.1	
4	Gate	no	1			6.0	
5	Horn prohibited sign post	Considered in engineering works					
Total							

Chainage (km)	107+900	
Structure ID No	School	
Village Name	Thumbur	
Side (Left/Right)	Right	
Distance from PCL (m)	36	
Length x Breadth (m)	8.5 x 33.5	
Proposed ROW (Equal on either side of PCL) (m)	11.5	
Impact	No direct impact	

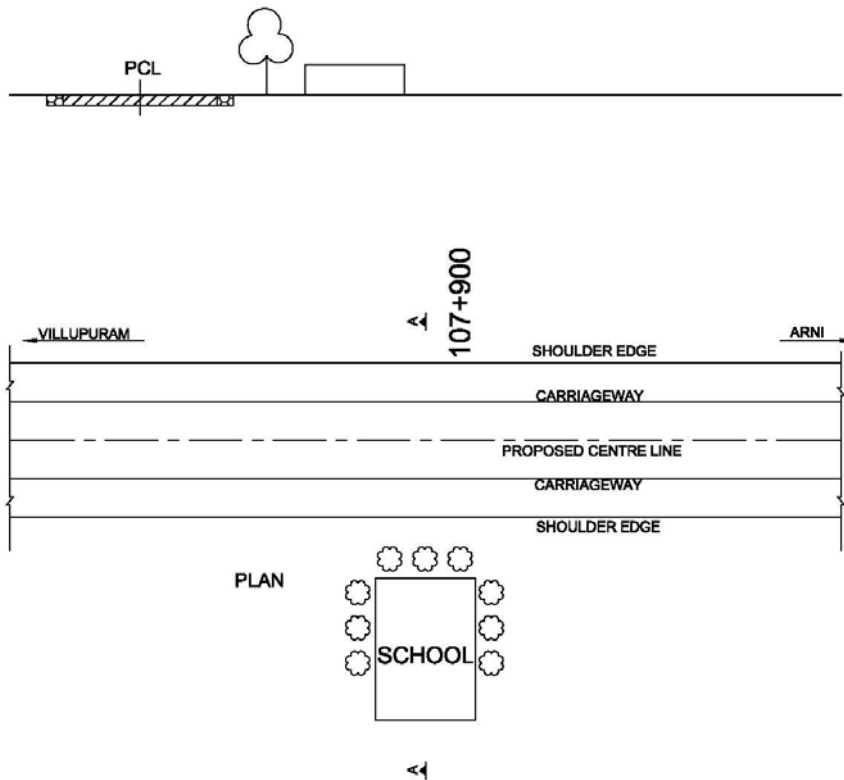

MITIGATION/ENHANCEMENT

S. No.	Description	Unit	Quantity	Rate (Rs.)	Amount (Rs.)	BOQ Item No.	
1	Construction of Boundary Wall	rm	8.5			6.0	
2	Tree Plantation	no	9			2.1	
3	Gate	no	1			6.0	
4	Horn prohibited sign post	Considered in engineering works					
				Total			

Chainage (km)	108+600	
Structure ID No	College	
Village Name	Lakshmipuram	
Side (Left/Right)	Right	
Distance from PCL (m)	12.5	
Length x Breadth (m)	72 x 108.5	
Proposed ROW (Equal on either side of PCL) (m)	11.5	
Impact	No direct impact	

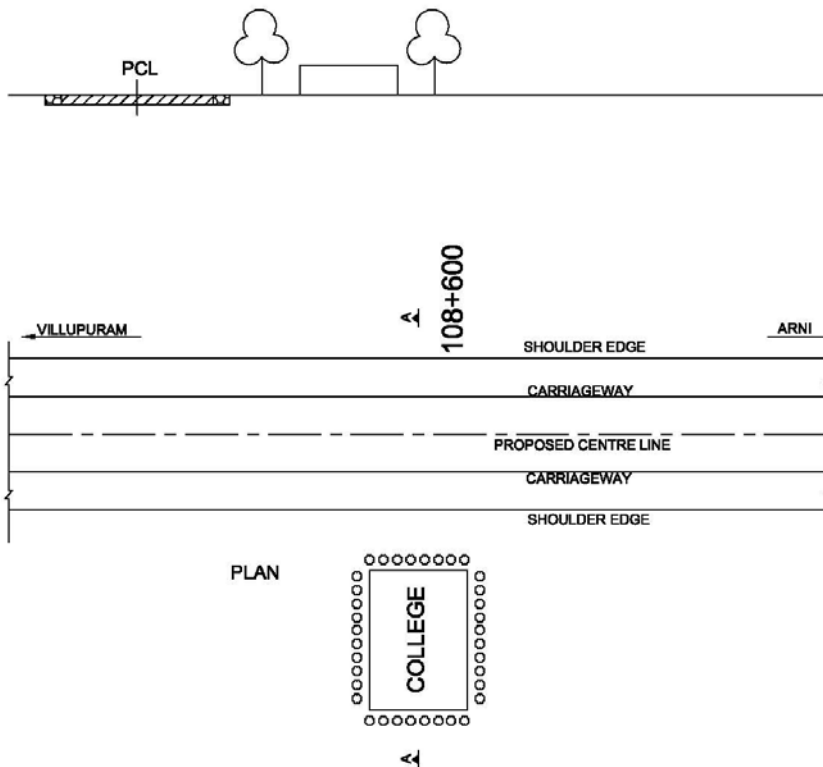

MITIGATION/ENHANCEMENT

S. No.	Description	Unit	Quantity	Rate (Rs.)	Amount (Rs.)	BOQ Item No.	
1	Construction of Boundary Wall	rm	72			6.0	
2	Tree Plantation	no	36			2.1	
3	Gate	no	1			6.0	
4	Horn prohibited sign post	Considered in engineering works					
Total							

Chainage (km)	109+200	
Structure ID No	School	
Village Name	Lakshmpuram	
Side (Left/Right)	Left	
Distance from PCL (m)	10.5	
Length x Breadth (m)	31.5 x 63.7	
Proposed ROW (Equal on either side of PCL) (m)	11.5	
Impact	direct impact	

←

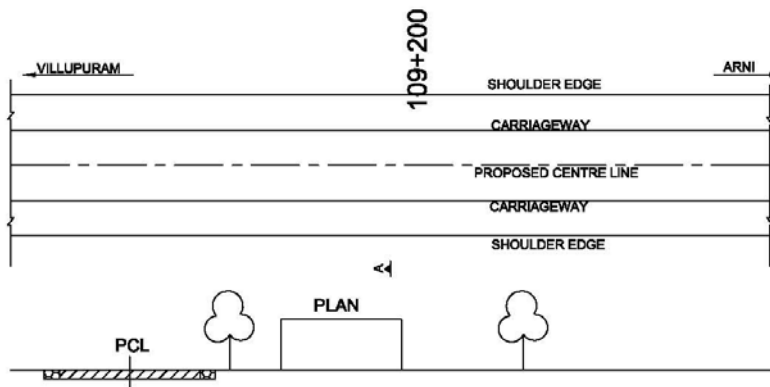
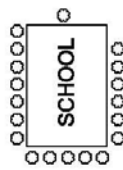

MITIGATION/ENHANCEMENT

S. No.	Description	Unit	Quantity	Rate (Rs.)	Amount (Rs.)	BOQ Item No.	
1	Construction of Boundary Wall	rm	31.5			6.0	
2	Tree Plantation	no	19			2.1	
3	Gate	no	1			6.0	
4	Horn prohibited sign post	Considered in engineering works					
Total							

Chainage (km)	109+850	
Structure ID No	School	
Village Name	Orathur	
Side (Left/Right)	Left	
Distance from PCL (m)	12	
Length x Breadth (m)	84.7 x 58.1	
Proposed ROW (Equal on either side of PCL) (m)	11.5	
Impact	No direct impact	

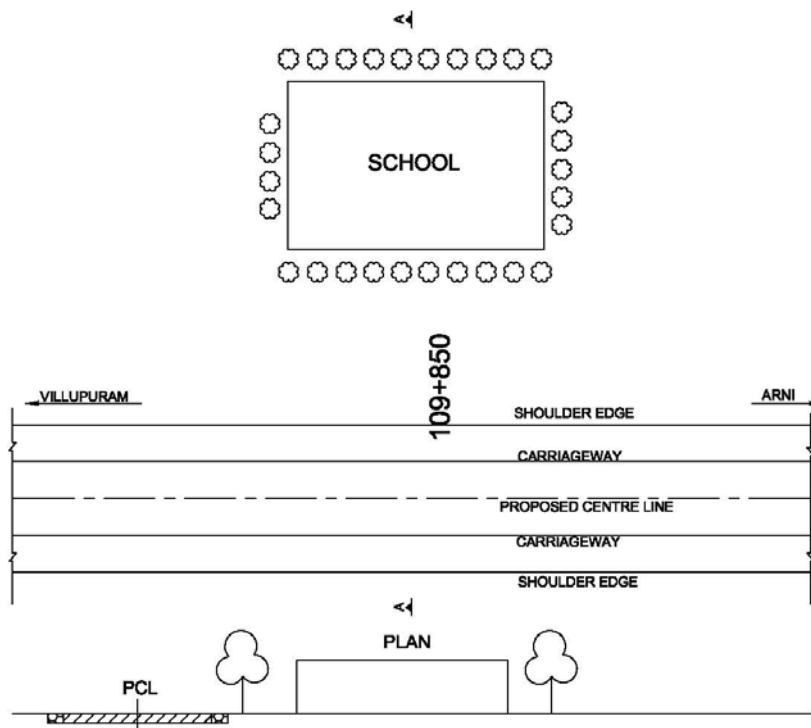

MITIGATION/ENHANCEMENT

S. No.	Description	Unit	Quantity	Rate (Rs.)	Amount (Rs.)	BOQ Item No.
1	Tree Plantation	No	29			2.1
2	Horn prohibited sign post	Considered in engineering works				
Total						

Chainage (km)	112+250	
Structure ID No	School	
Village Name	Puthomedu	
Side (Left/Right)	Right	
Distance from PCL (m)	39.5	
Length x Breadth (m)	16 x 65	
Proposed ROW (Equal on either side of PCL) (m)	8	
Impact	No direct impact	

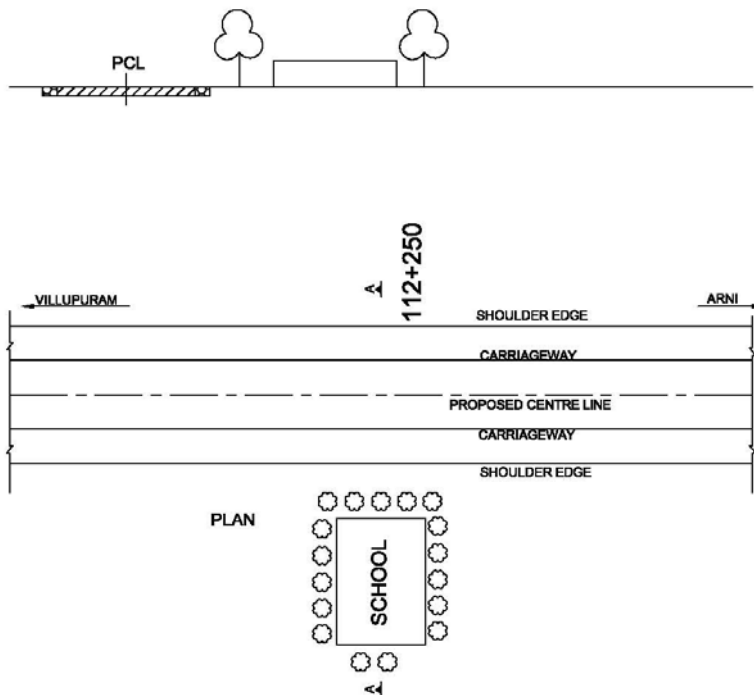

MITIGATION/ENHANCEMENT

S. No.	Description	Unit	Quantity	Rate (Rs.)	Amount (Rs.)	BOQ Item No.	
1	Construction of Boundary Wall	rm	16			6.0	
2	Tree Plantation	no	17			2.1	
3	Gate	no	1			6.0	
4	Horn prohibited sign post	Considered in engineering works					
Total							

Chainage (km)	114+250	
Structure ID No	School	
Village Name	Papankulam	
Side (Left/Right)	Left	
Distance from PCL (m)	15.5	
Length x Breadth (m)	28 x 50	
Proposed ROW (Equal on either side of PCL) (m)	8	
Impact	No direct impact	

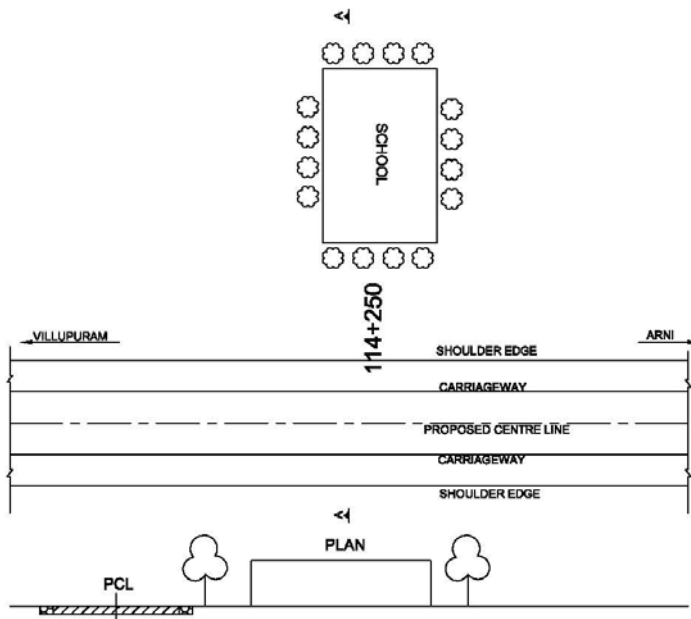

MITIGATION/ENHANCEMENT

S. No.	Description	Unit	Quantity	Rate (Rs.)	Amount (Rs.)	BOQ Item No.
1	Tree Plantation	No	16			2.1
2	Horn prohibited sign post	Considered in engineering works				
Total						

Community Structures along SH 04

ARNI



VILLUPURAM

Chainage (km)	29+300
Structure ID No	Temple
Village Name	Arni
Side (Left/Right)	Left
Distance from PCL (m)	7
Length x Breadth (m)	5.5 x 3
Proposed ROW (Equal on either side of PCL) (m)	8
Impact	direct impact

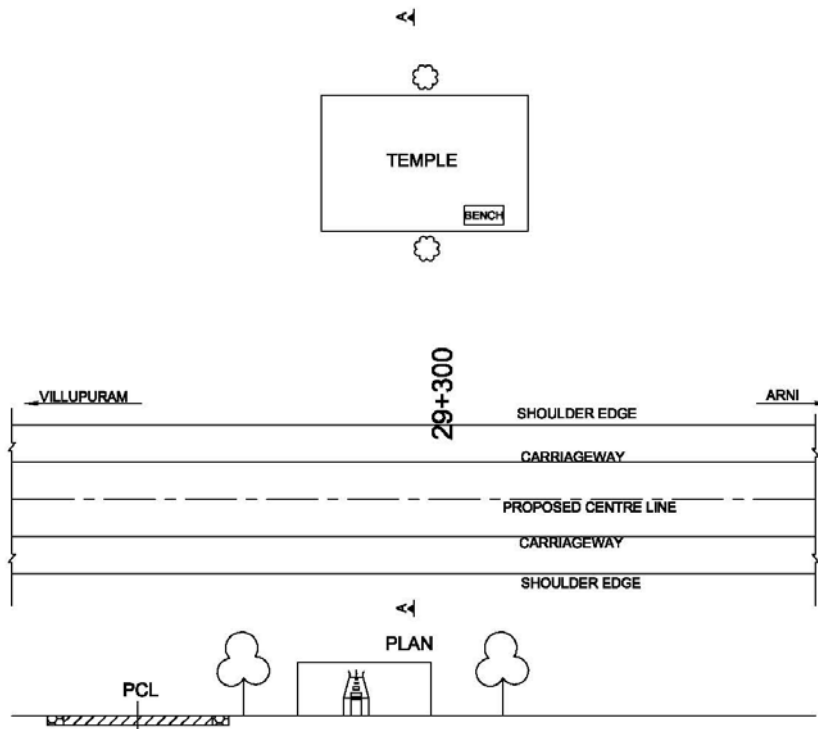

MITIGATION/ENHANCEMENT

S. No.	Description	Unit	Quantity	Rate (Rs.)	Amount (Rs.)	BOQ Item No.
1	Demolition of platform	rm	1.5			6.0
2	Seating bench	No	1			6.0
3	Tree Plantation	No	2			2.1
Total						

Chainage (km)	29+700	
Structure ID No	Mosque	
Village Name	Arni	
Side (Left/Right)	Right	
Distance from PCL (m)	4	
Length x Breadth (m)	5 x 10	
Proposed ROW (Equal on either side of PCL) (m)	8	
Impact	direct impact	

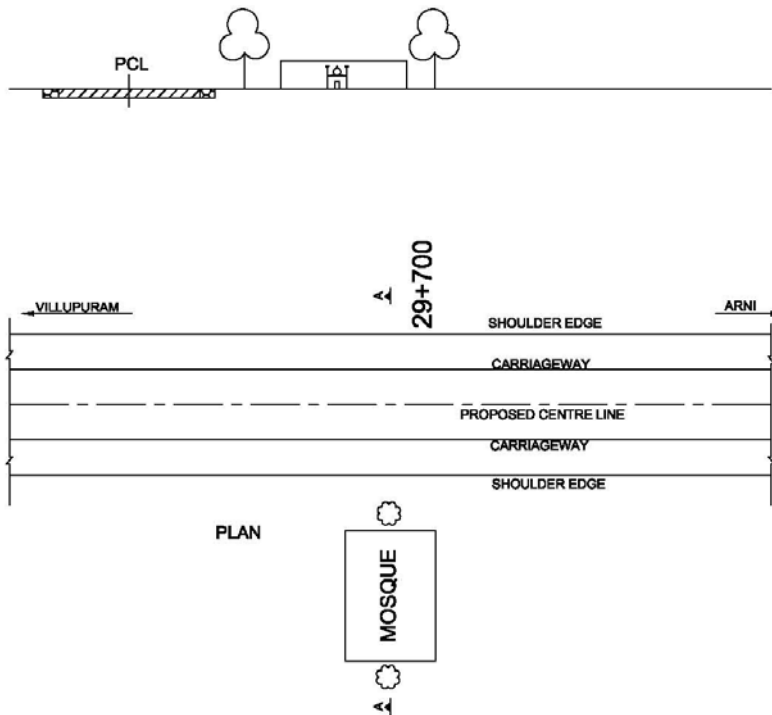

MITIGATION/ENHANCEMENT

S. No.	Description	Unit	Quantity	Rate (Rs.)	Amount (Rs.)	BOQ Item No.
1	Demolition of boundary Wall	rm	14			6.0
2	Construction of boundary Wall	rm	5			6.0
3	Tree Plantation	No	2			2.1
4	Gate	no	1			6.0
Total						

Chainage (km)	29+800	
Structure ID No	Mosque	
Village Name	Arni	
Side (Left/Right)	Left	
Distance from PCL (m)	6	
Length x Breadth (m)	25 x 9	
Proposed ROW (Equal on either side of PCL) (m)	8	
Impact	direct impact	

41

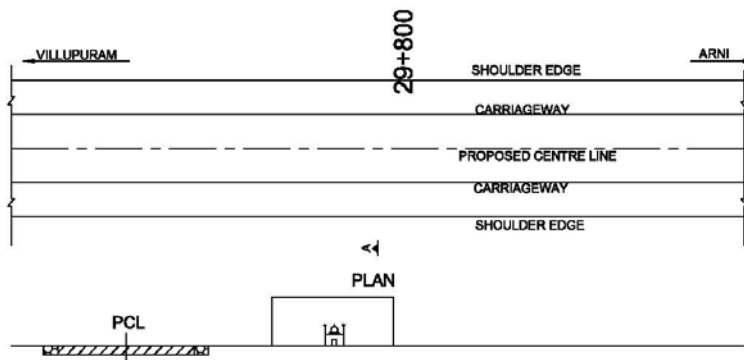
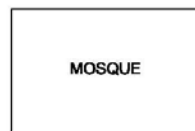

MITIGATION/ENHANCEMENT

S. No.	Description	Unit	Quantity	Rate (Rs.)	Amount (Rs.)	BOQ Item No.
1	Demolition of gate	No	1			6.0
2	Gate	No	1			6.0
Total						

Chainage (km)	29+900
Structure ID No	Temple (2 nos)
Village Name	Arni
Side (Left/Right)	Right
Distance from PCL (m)	6.5
Length x Breadth (m)	4x 3
Proposed ROW (Equal on either side of PCL) (m)	8
Impact	direct impact

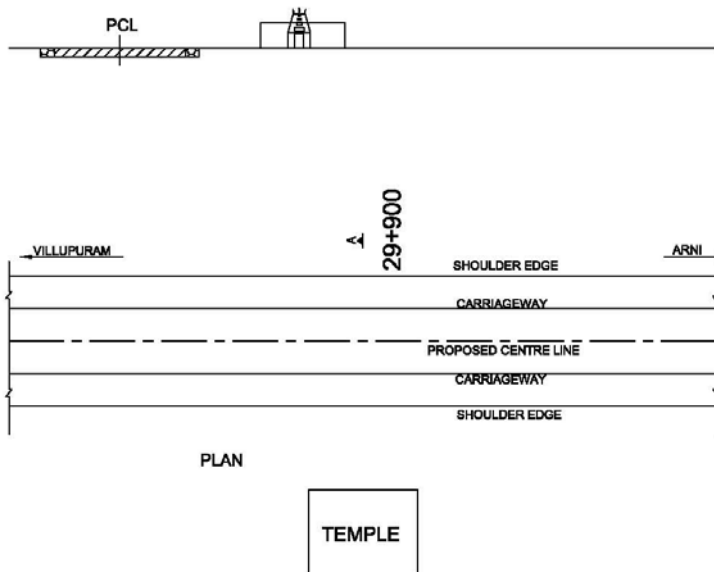

MITIGATION/ENHANCEMENT

S. No.	Description	Unit	Quantity	Rate (Rs.)	Amount (Rs.)	BOQ Item No.
1	Demolition of platform	rm	4			6.0
Total						

Chainage (km)	29+900	
Structure ID No	Temple (2 nos)	
Village Name	Arni	
Side (Left/Right)	Right	
Distance from PCL (m)	6.5	
Length x Breadth (m)	4x 3	
Proposed ROW (Equal on either side of PCL) (m)	8	
Impact	direct impact	

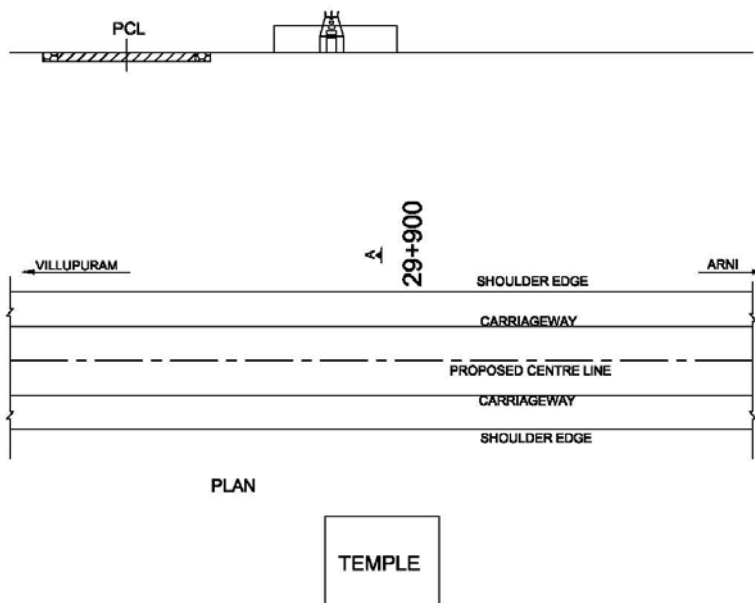

MITIGATION/ENHANCEMENT

S. No.	Description	Unit	Quantity	Rate (Rs.)	Amount (Rs.)	BOQ Item No.
1	Demolition of platform	rm	4			6.0
Total						

Chainage (km)	30+000
Structure ID No	Temple
Village Name	Arni
Side (Left/Right)	Right
Distance from PCL (m)	5
Length x Breadth (m)	2 x 2
Proposed ROW (Equal on either side of PCL) (m)	8
Impact	direct impact

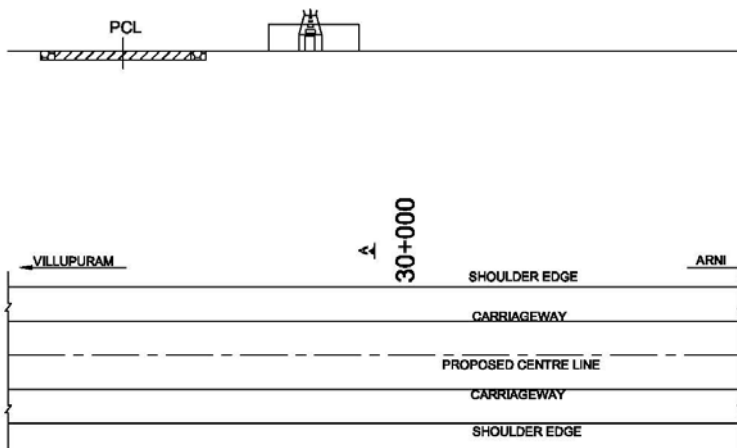

PLAN

TEMPLE

MITIGATION/ENHANCEMENT

S. No.	Description	Unit	Quantity	Rate (Rs.)	Amount (Rs.)	BOQ Item No.
1	demolition	nil	nil	nil	nil	nil
Total						

Chainage (km)	30+100	
Structure ID No	Temple	
Village Name	Arni	
Side (Left/Right)	Right	
Distance from PCL (m)	5	
Length x Breadth (m)	19 x 11	
Proposed ROW (Equal on either side of PCL) (m)	8	
Impact	direct impact	

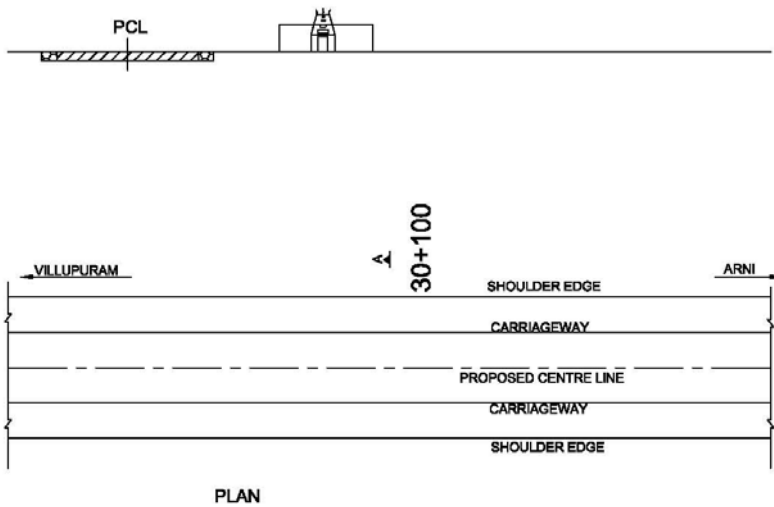

MITIGATION/ENHANCEMENT

S. No.	Description	Unit	Quantity	Rate (Rs.)	Amount (Rs.)	BOQ Item No.
1	Realignment explored	nil	nil	nil	nil	nil
Total						

Chainage (km)	30+100	
Structure ID No	Temple	
Village Name	Arni	
Side (Left/Right)	Right	
Distance from PCL (m)	6	
Length x Breadth (m)	6 x 6	
Proposed ROW (Equal on either side of PCL) (m)	8	
Impact	direct impact	

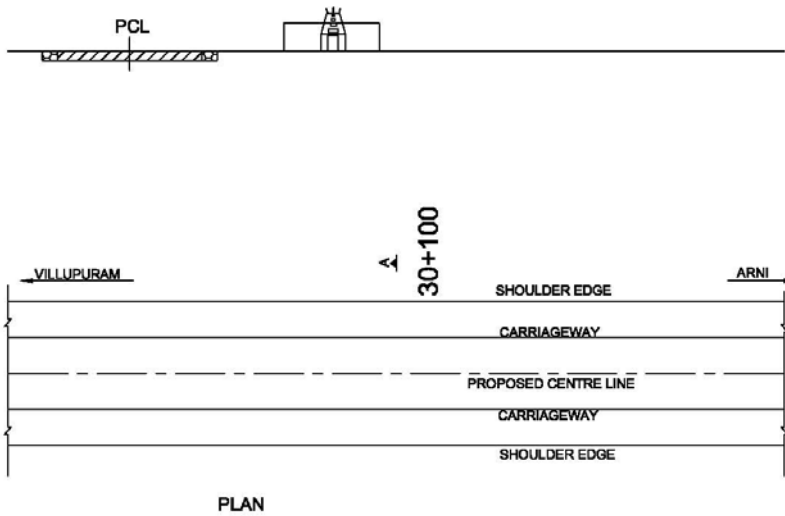

MITIGATION/ENHANCEMENT

S. No.	Description	Unit	Quantity	Rate (Rs.)	Amount (Rs.)	BOQ Item No.
1	Realignment explored	nil	nil	nil	nil	nil
Total						

Chainage (km)	30+600	
Structure ID No	Temple (statue)	
Village Name	Arni	
Side (Left/Right)	Left	
Distance from PCL (m)	10	
Length x Breadth (m)	1.5 x 1.5	
Proposed ROW (Equal on either side of PCL) (m)	11.5	
Impact	direct impact	

<4

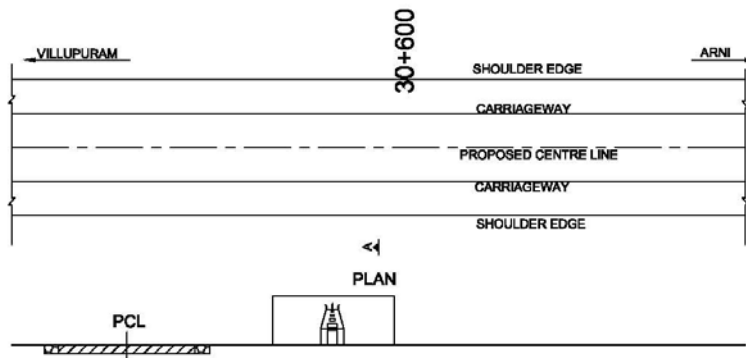
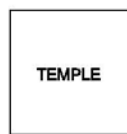

MITIGATION/ENHANCEMENT

S. No.	Description	Unit	Quantity	Rate (Rs.)	Amount (Rs.)	BOQ Item No.
1	demolition	nil	nil	nil	nil	nil
Total						

Chainage (km)	31+500	
Structure ID No	Temple	
Village Name	Sitheri	
Side (Left/Right)	Right	
Distance from PCL (m)	5.5	
Length x Breadth (m)	18 x 15	
Proposed ROW (Equal on either side of PCL) (m)	8	
Impact	direct impact	

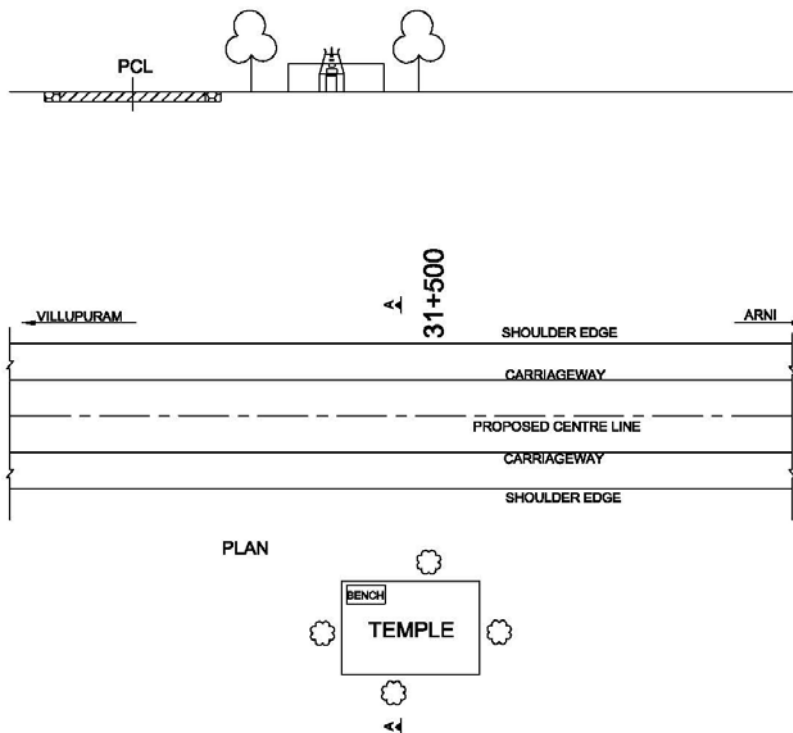

MITIGATION/ENHANCEMENT

S. No.	Description	Unit	Quantity	Rate (Rs.)	Amount (Rs.)	BOQ Item No.
1	Demolition of boundary Wall	rm	23			6.0
2	Construction of boundary Wall	rm	18			6.0
3	Seating bench	No	1			6.0
4	Tree Plantation	No	4			2.1
5	Gate	no	1			6.0
Total						

Chainage (km)	32+900
Structure ID No	Temple
Village Name	Nesal
Side (Left/Right)	Right
Distance from PCL (m)	7
Length x Breadth (m)	9.8 x 9
Proposed ROW (Equal on either side of PCL) (m)	8
Impact	direct impact

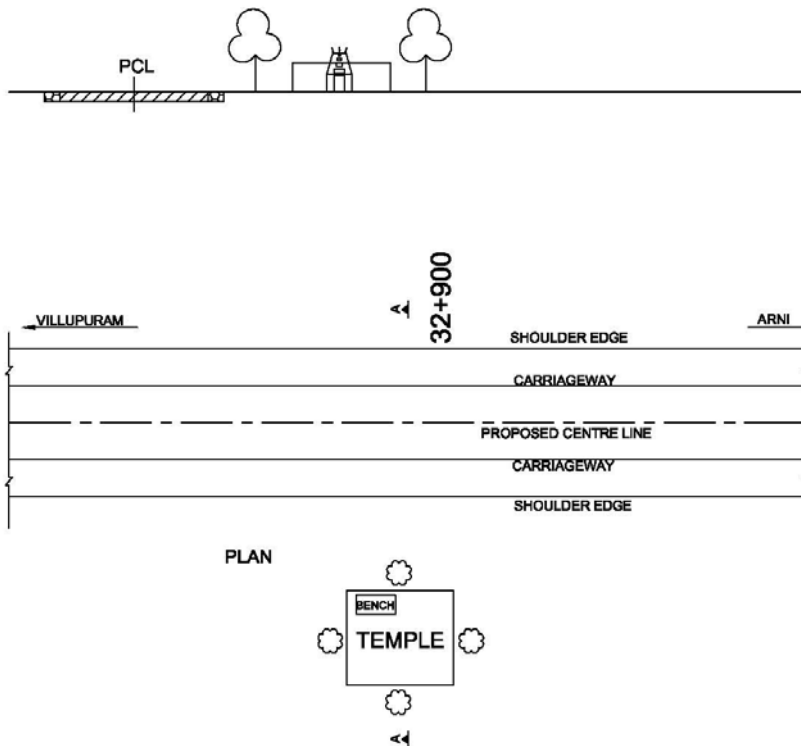

MITIGATION/ENHANCEMENT

S. No.	Description	Unit	Quantity	Rate (Rs.)	Amount (Rs.)	BOQ Item No.
1	Demolition of boundary Wall	rm	12			6.0
2	Construction of boundary Wall	rm	9.8			6.0
3	Seating bench	No	1			6.0
4	Tree Plantation	No	4			2.1
5	Gate	no	1			6.0
Total						

Chainage (km)	36+750	
Structure ID No	Temple	
Village Name	Nesal	
Side (Left/Right)	Right	
Distance from PCL (m)	11	
Length x Breadth (m)	19 x 32	
Proposed ROW (Equal on either side of PCL) (m)	11.5	
Impact	direct impact	

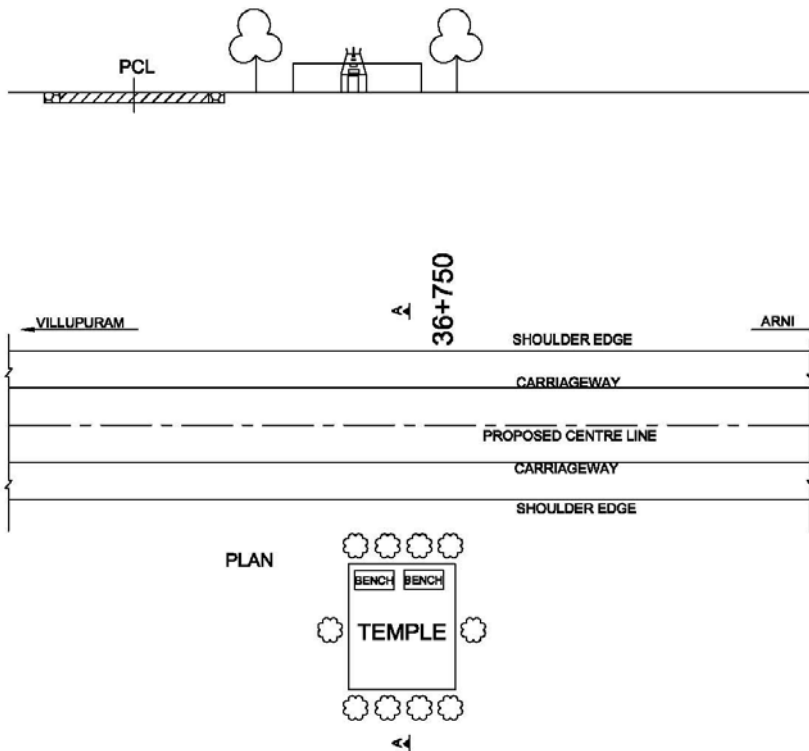

MITIGATION/ENHANCEMENT

S. No.	Description	Unit	Quantity	Rate (Rs.)	Amount (Rs.)	BOQ Item No.
1	Demolition of boundary Wall	rm	20			6.0
2	Construction of boundary Wall	rm	19			6.0
3	Seating bench	No	2			6.0
4	Tree Plantation	No	10			2.1
5	Gate	no	1			6.0
Total						

Chainage (km)	37+650	
Structure ID No	Temple	
Village Name	Vinnamangal	
Side (Left/Right)	Right	
Distance from PCL (m)	9	
Length x Breadth (m)	35.5 x 28.5	
Proposed ROW (Equal on either side of PCL) (m)	11.5	
Impact	direct impact	

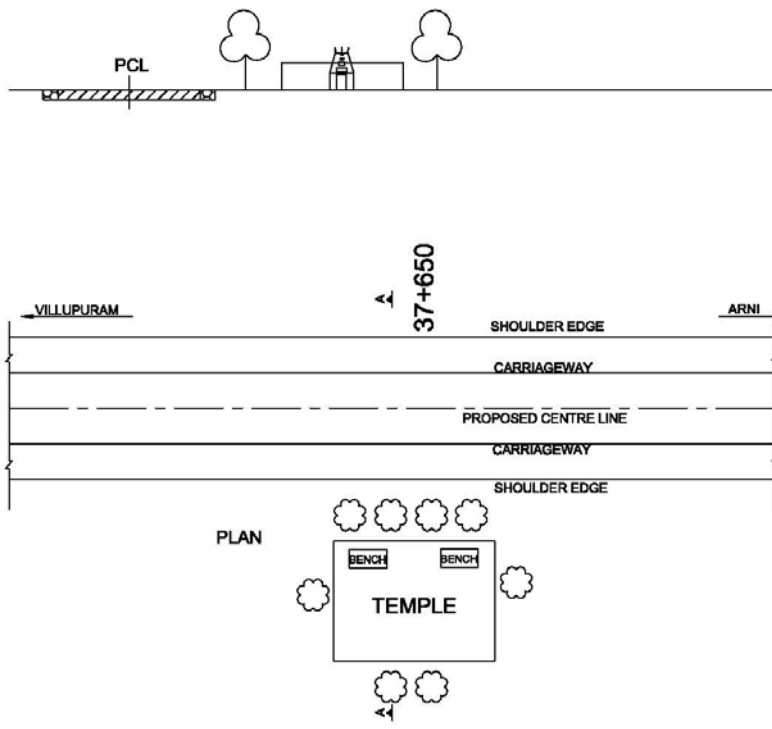

MITIGATION/ENHANCEMENT

S. No.	Description	Unit	Quantity	Rate (Rs.)	Amount (Rs.)	BOQ Item No.
1	Demolition of Gate	rm	1			6.0
2	Seating bench	No	2			6.0
3	Tree Plantation	No	10			2.1
4	Gate	no	1			6.0
Total						

hainage (km)	37+875	
Structure ID No	Temple	
Village Name	Vinnamangal	
Side (Left/Right)	Right	
Distance from PCL (m)	8.5	
Length x Breadth (m)	5 x 7	
Proposed ROW (Equal on either side of PCL) (m)	11.5	
Impact	direct impact	

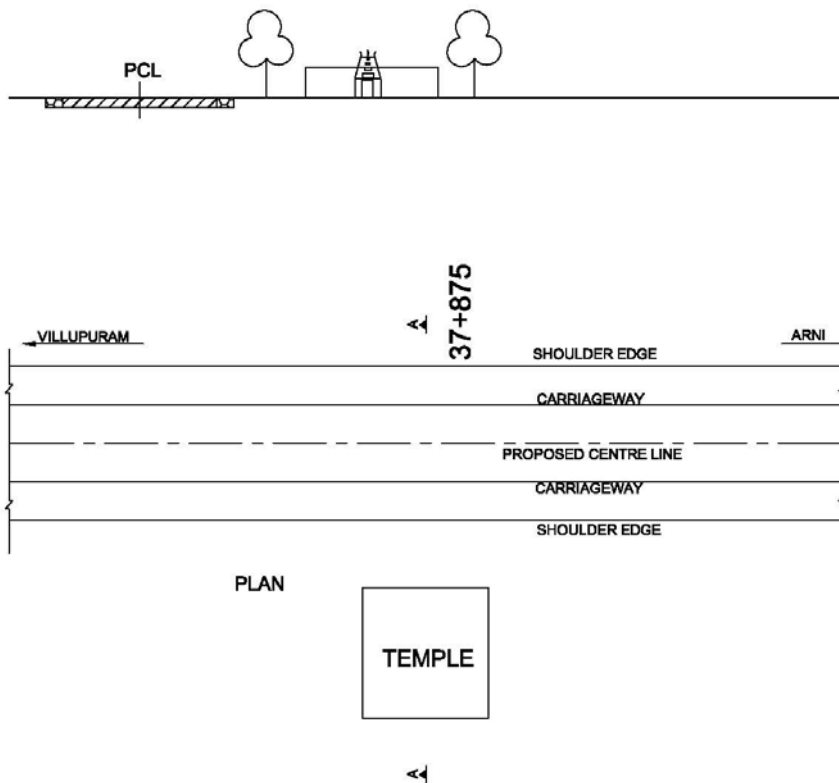

MITIGATION/ENHANCEMENT

S. No.	Description	Unit	Quantity	Rate (Rs.)	Amount (Rs.)	BOQ Item No.
1	Realignment explored	nil	nil	nil	nil	nil
Total						

Chainage (km)	41+450	
Structure ID No	Temple	
Village Name	Kollappalur	
Side (Left/Right)	Right	
Distance from PCL (m)	10.5	
Length x Breadth (m)	5 x 7	
Proposed ROW (Equal on either side of PCL) (m)	11.5	
Impact	direct impact	

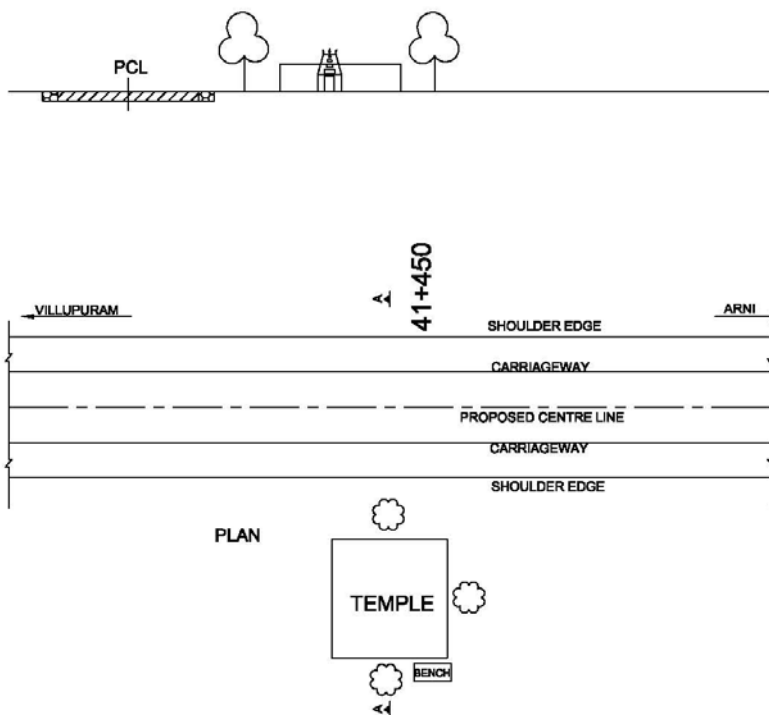

MITIGATION/ENHANCEMENT

S. No.	Description	Unit	Quantity	Rate (Rs.)	Amount (Rs.)	BOQ Item No.
1	Demolition of mandapam	No	1			6.0
2	Seating bench	No	1			6.0
3	Tree Plantation	No	3			2.1
Total						

Chainage (km)	42+575
Structure ID No	Temple
Village Name	Kollappalur
Side (Left/Right)	Right
Distance from PCL (m)	7
Length x Breadth (m)	8 x 11
Proposed ROW (Equal on either side of PCL) (m)	11.5
Impact	direct impact

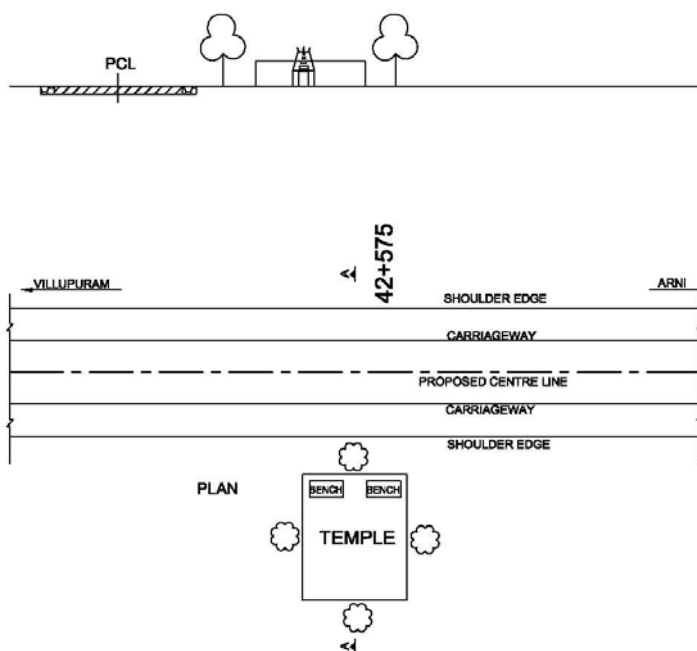

MITIGATION/ENHANCEMENT

S. No.	Description	Unit	Quantity	Rate (Rs.)	Amount (Rs.)	BOQ Item No.
1	Demolition of Structure	rm	13			6.0
2	Seating bench	No	2			6.0
3	Tree Plantation	No	4			2.1
4	Gate	no	1			6.0
Total						

Chainage (km)	43+525
Structure ID No	Temple
Village Name	Indravarnam
Side (Left/Right)	Left
Distance from PCL (m)	6.5
Length x Breadth (m)	3 x 2.5
Proposed ROW (Equal on either side of PCL) (m)	11.5
Impact	direct impact



<4

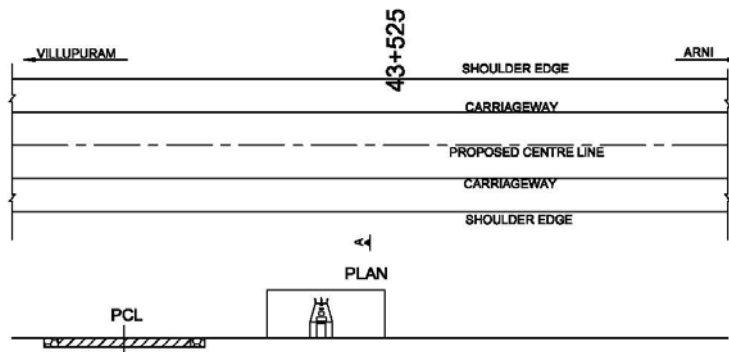

MITIGATION/ENHANCEMENT

S. No.	Description	Unit	Quantity	Rate (Rs.)	Amount (Rs.)	BOQ Item No.
1	Realignment explored	nil	nil	nil	nil	nil
Total						

Chainage (km)	44+100	
Structure ID No	Temple	
Village Name	Indravanam	
Side (Left/Right)	Right	
Distance from PCL(m)	7.7	
Length x Breadth(m)	1 x 1	
Proposed ROW (Equal on either side of PCL) (m)	11.5	
Impact	direct impact	

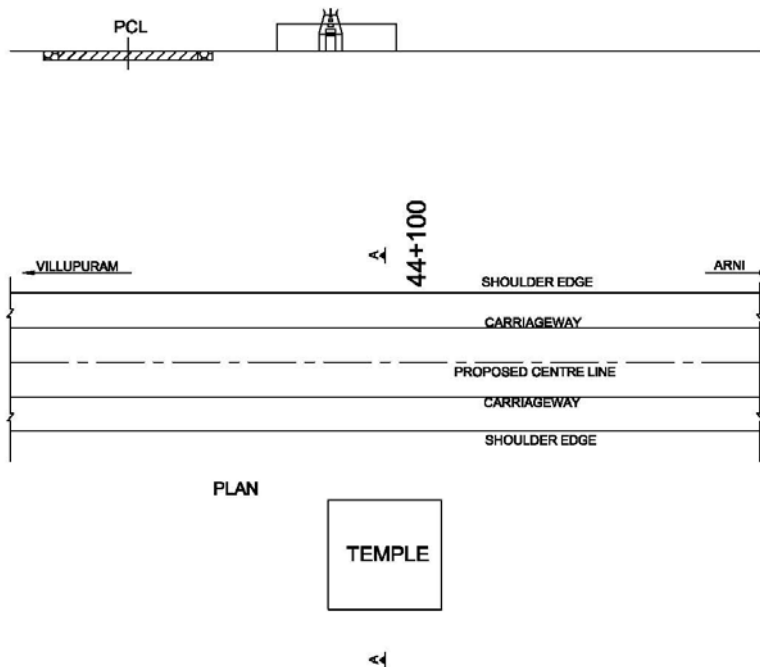

MITIGATION/ENHANCEMENT

S. No.	Description	Unit	Quantity	Rate (Rs.)	Amount (Rs.)	BOQ Item No.
1	Demolition	nil	nil	nil	nil	nil
Total						

Chainage (km)	45+700
Structure ID No	Temple
Village Name	Chammambadi
Side (Left/Right)	Right
Distance from PCL(m)	6.5
Length x Breadth(m)	6.5 x 5.5
Proposed ROW (Equal on either side of PCL) (m)	11.5
Impact	direct impact

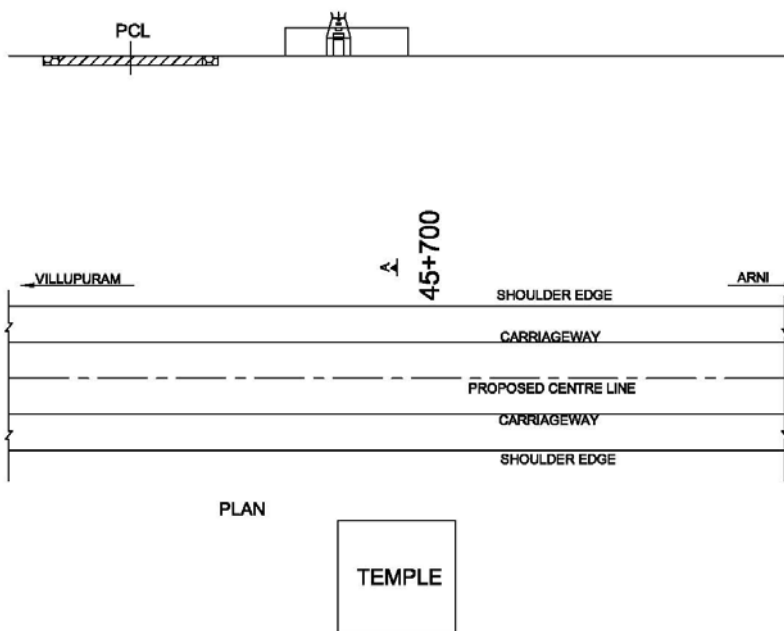

MITIGATION/ENHANCEMENT

S. No.	Description	Unit	Quantity	Rate (Rs.)	Amount (Rs.)	BOQ Item No.
1	Realignment explored	nil	nil	nil	nil	nil
Total						

Chainage (km)	46+375	
Structure ID No	Temple	
Village Name	Chammambadi	
Side (Left/Right)	Left	
Distance from PCL(m)	9.8	
Length x Breadth(m)	1 x 1	
Proposed ROW (Equal on either side of PCL) (m)	11.5	
Impact	direct impact	

◀

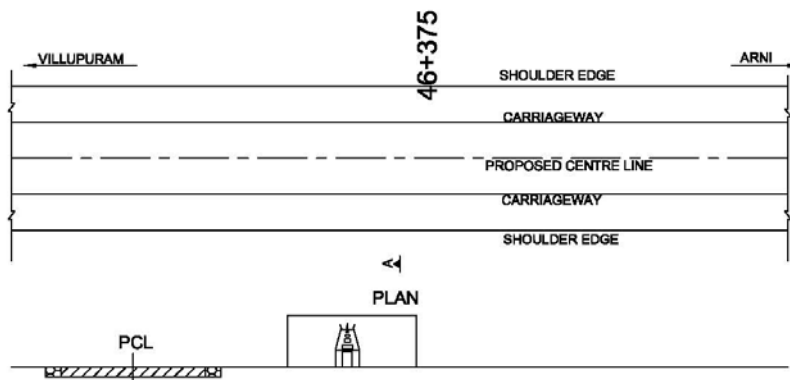
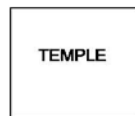

MITIGATION/ENHANCEMENT

S. No.	Description	Unit	Quantity	Rate (Rs.)	Amount (Rs.)	BOQ Item No.
1	Demolition	nil	nil	nil	nil	nil
Total						

Chainage (km)	48+650
Structure ID No	Temple
Village Name	Yangasudamani
Side (Left/Right)	Right
Distance from PCL(m)	7.7
Length x Breadth(m)	1 x 2
Proposed ROW (Equal on either side of PCL) (m)	11.5
Impact	direct impact

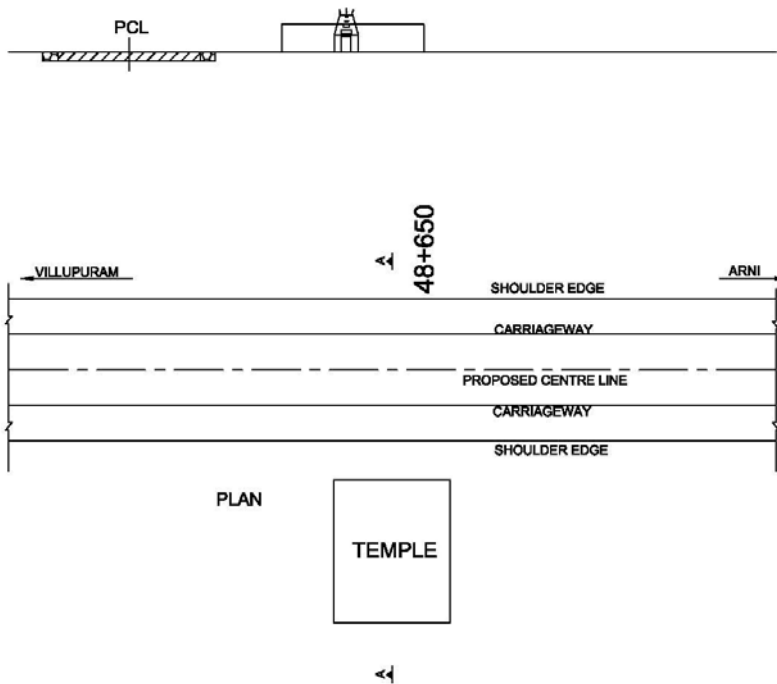

MITIGATION/ENHANCEMENT

S. No.	Description	Unit	Quantity	Rate (Rs.)	Amount (Rs.)	BOQ Item No.
1	Demolition	nil	nil	nil	nil	nil
Total						

Chainage (km)	52+450
Structure ID No	Temple
Village Name	Chetpet
Side (Left/Right)	Right
Distance from PCL(m)	7.7
Length x Breadth(m)	25.5 x 19.5
Proposed ROW (Equal on either side of PCL) (m)	8
Impact	direct impact

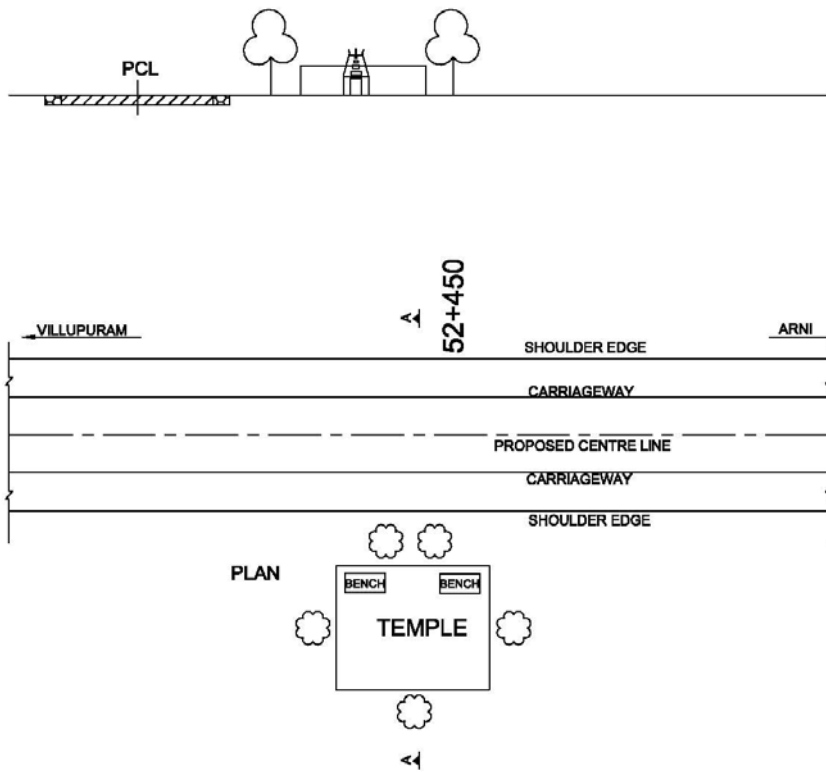

MITIGATION/ENHANCEMENT

S. No.	Description	Unit	Quantity	Rate (Rs.)	Amount (Rs.)	BOQ Item No.
1	Demolition of boundary Wall	rm	26			6.0
2	Construction of boundary Wall	rm	25.5			6.0
3	Seating bench	No	2			6.0
4	Tree Plantation	No	5			2.1
5	Gate	no	1			6.0
Total						

Chainage (km)	62+600
Structure ID No	Temple
Village Name	Devanur
Side (Left/Right)	Right
Distance from PCL(m)	5
Length x Breadth(m)	4 x 2
Proposed ROW (Equal on either side of PCL) (m)	11.5
Impact	direct impact

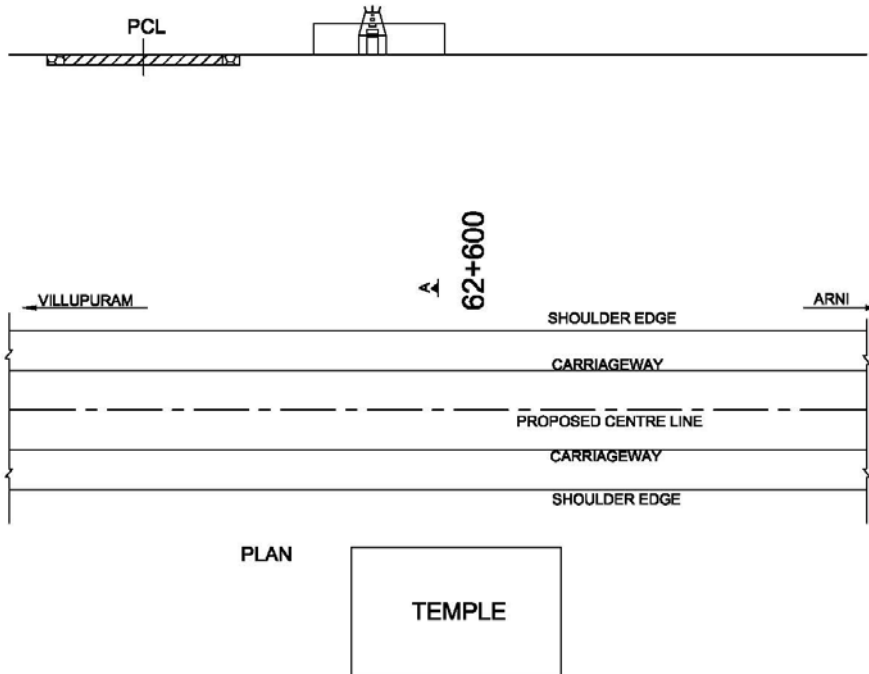

MITIGATION/ENHANCEMENT

S. No.	Description	Unit	Quantity	Rate (Rs.)	Amount (Rs.)	BOQ Item No.
1	Demolition	nil	nil	nil	nil	nil
Total						

Chainage (km)	65+600	
Structure ID No	Temple	
Village Name	Valathy	
Side (Left/Right)	Right	
Distance from PCL(m)	7	
Length x Breadth(m)	5.5 x 5.5	
Proposed ROW (Equal on either side of PCL) (m)	11.5	
Impact	direct impact	

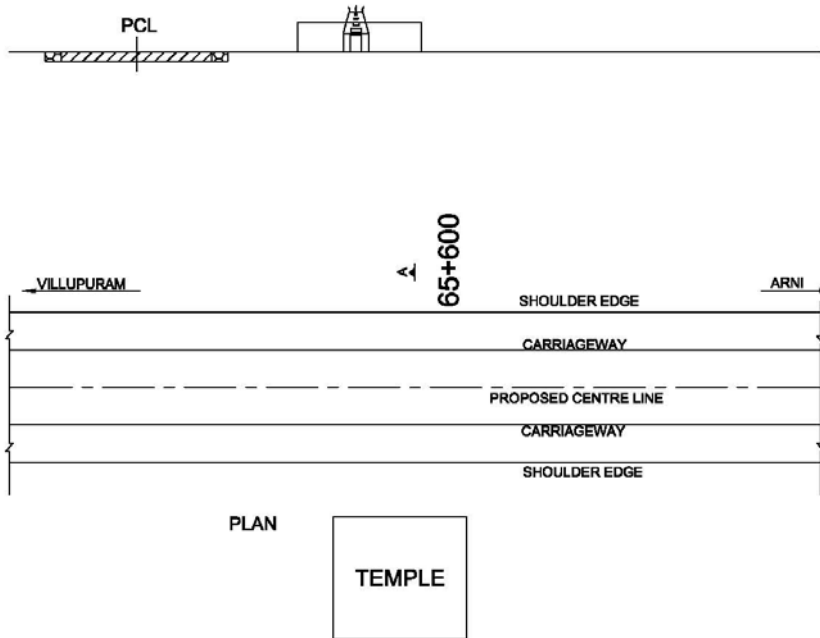

MITIGATION/ENHANCEMENT

S. No.	Description	Unit	Quantity	Rate (Rs.)	Amount (Rs.)	BOQ Item No.
1	Realignment explored	nil	nil	nil	nil	nil
Total						

Chainage (km)	65+880
Structure ID No	Temple
Village Name	Valathy
Side (Left/Right)	Right
Distance from PCL(m)	8
Length x Breadth(m)	21 x 21
Proposed ROW (Equal on either side of PCL) (m)	11.5
Impact	direct impact

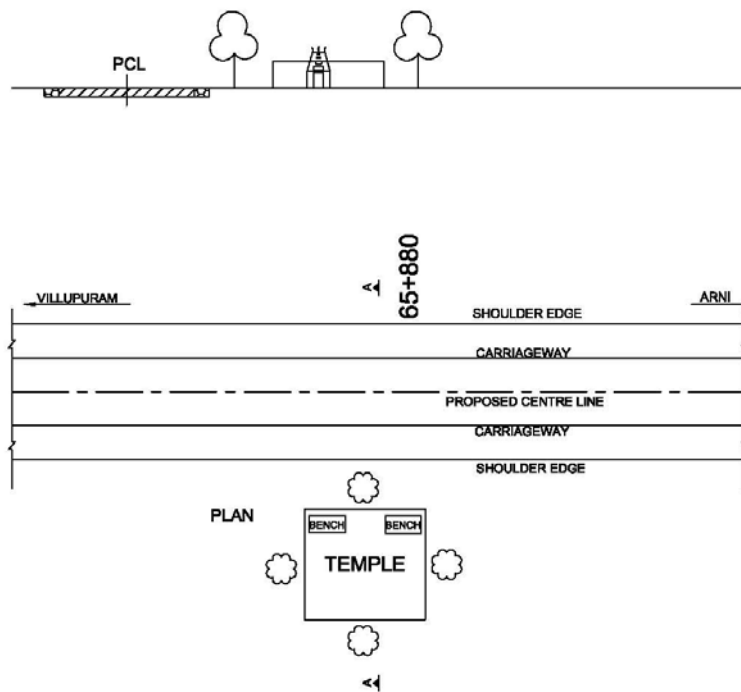

MITIGATION/ENHANCEMENT

S. No.	Description	Unit	Quantity	Rate (Rs.)	Amount (Rs.)	BOQ Item No.
1	Demolition of boundary Wall	rm	28			6.0
2	Construction of boundary Wall	rm	21			6.0
3	Seating bench	No	2			6.0
4	Tree Plantation	No	4			2.1
5	Gate	no	1			6.0
Total						

Chainage (km)	66+200
Structure ID No	Grave yard
Village Name	Valathy
Side (Left/Right)	Left
Distance from PCL(m)	10.5
Length x Breadth(m)	35 x 7
Proposed ROW (Equal on either side of PCL) (m)	11.5
Impact	direct impact



◀

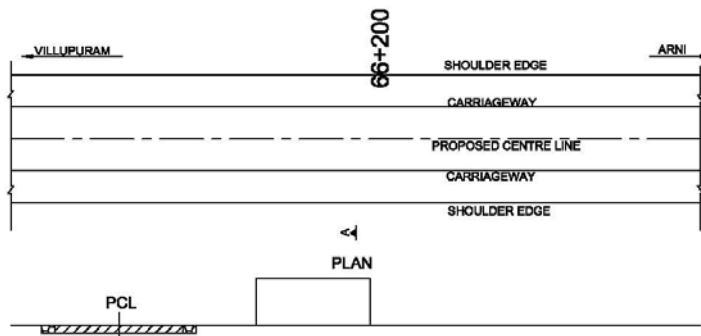
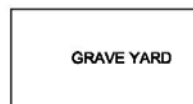

MITIGATION/ENHANCEMENT

S. No.	Description	Unit	Quantity	Rate (Rs.)	Amount (Rs.)	BOQ Item No.
1	Realignment explored	nil	nil	nil	nil	nil
Total						

Chainage (km)	66+300
Structure ID No	Graveyard+crematoria
Village Name	Kannalam
Side (Left/Right)	Left
Distance from PCL(m)	7
Length x Breadth(m)	35 x 32
Proposed ROW (Equal on either side of PCL) (m)	11.5
Impact	direct impact



◀

GRAVE YARD
+CREMATORIA

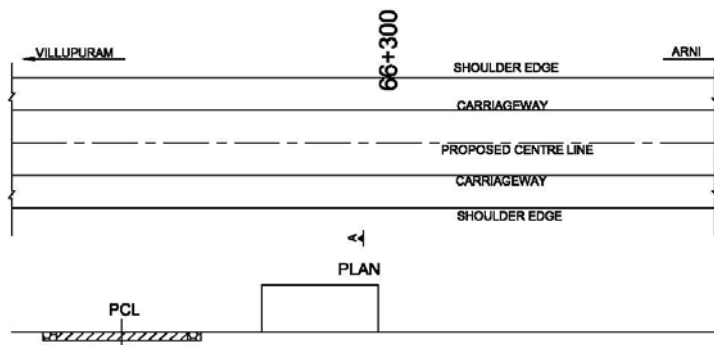

MITIGATION/ENHANCEMENT

S. No.	Description	Unit	Quantity	Rate (Rs.)	Amount (Rs.)	BOQ Item No.
1	Realignment explored	nil	nil	nil	nil	nil
Total						

Chainage (km)	66+970
Structure ID No	Statue
Village Name	Kannalam
Side (Left/Right)	Right
Distance from PCL(m)	7.5
Length x Breadth(m)	1 x 2
Proposed ROW (Equal on either side of PCL) (m)	8
Impact	direct impact

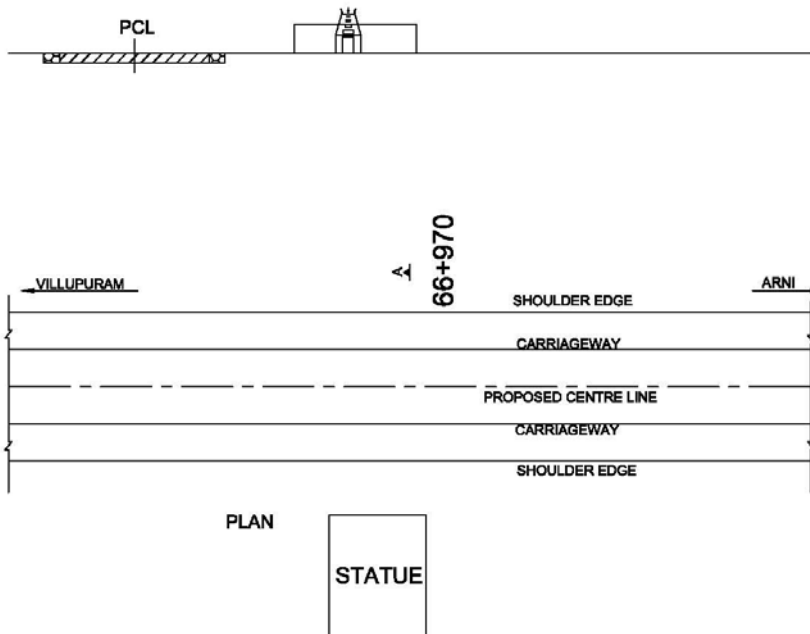

MITIGATION/ENHANCEMENT

S. No.	Description	Unit	Quantity	Rate (Rs.)	Amount (Rs.)	BOQ Item No.
1	Demolition	nil	nil	nil	nil	nil
Total						

Chainage (km)	67+350
Structure ID No	Temple
Village Name	Kannalam
Side (Left/Right)	Right
Distance from PCL(m)	6.3
Length x Breadth(m)	11 x 15
Proposed ROW (Equal on either side of PCL) (m)	11.5
Impact	direct impact

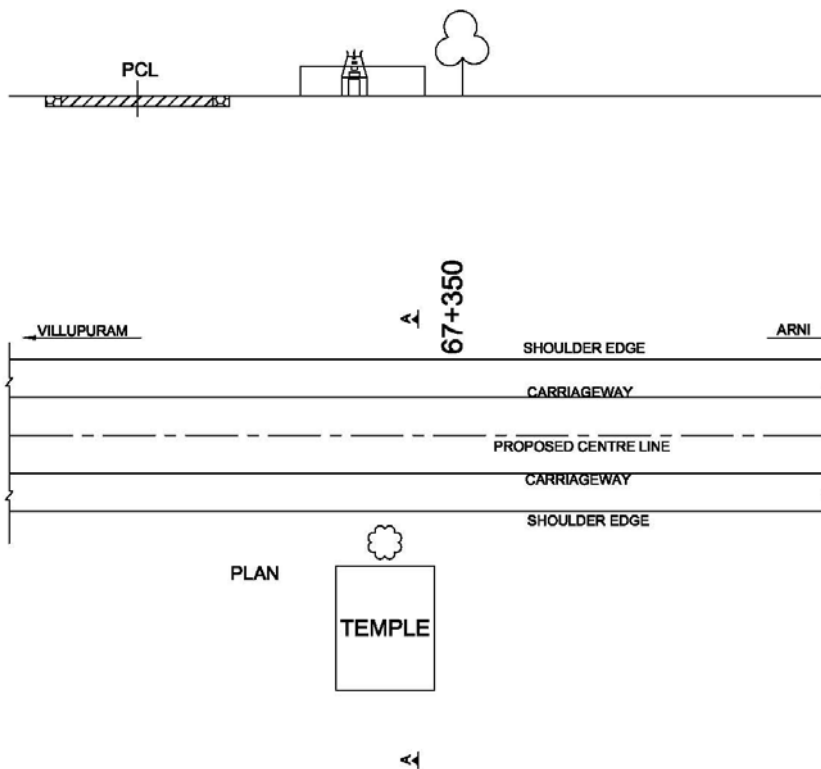

MITIGATION/ENHANCEMENT

S. No.	Description	Unit	Quantity	Rate (Rs.)	Amount (Rs.)	BOQ Item No.
1	Demolition	rm	11			6.0
2	Tree plantation	No	1			2.1
Total						

Chainage (km)	67+862	
Structure ID No	Temple	
Village Name	Kannalam	
Side (Left/Right)	Right	
Distance from PCL(m)	8.5	
Length x Breadth(m)	12.5 x 13	
Proposed ROW (Equal on either side of PCL) (m)	11.5	
Impact	direct impact	

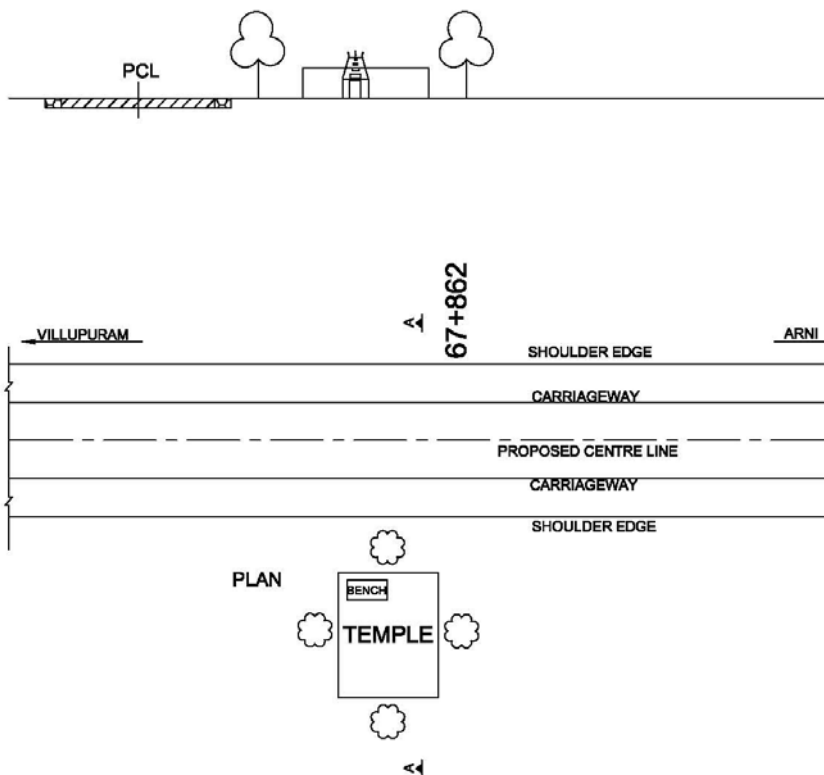

MITIGATION/ENHANCEMENT

S. No.	Description	Unit	Quantity	Rate (Rs.)	Amount (Rs.)	BOQ Item No.
1	Demolition of boundary Wall	rm	18.5			6.0
2	Construction of boundary Wall	rm	12.5			6.0
3	Seating bench	No	1			6.0
4	Tree Plantation	No	4			2.1
5	Gate	no	1			6.0
Total						

Chainage (km)	68+350
Structure ID No	Grave yard
Village Name	Kannalam
Side (Left/Right)	Left
Distance from PCL(m)	7
Length x Breadth(m)	14 x 7
Proposed ROW (Equal on either side of PCL) (m)	11.5
Impact	direct impact



41

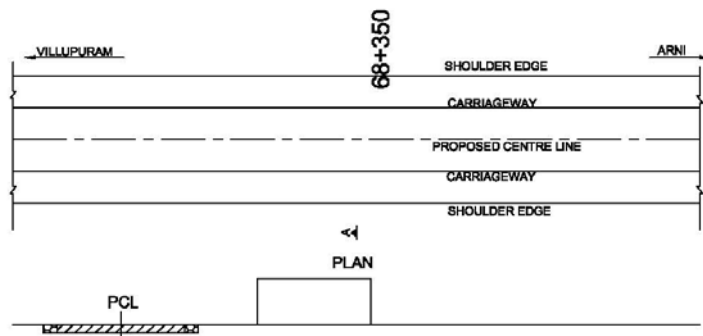

MITIGATION/ENHANCEMENT

S. No.	Description	Unit	Quantity	Rate (Rs.)	Amount (Rs.)	BOQ Item No.
1	Realignment explored	nil	nil	nil	nil	nil
Total						

Chainage (km)	71+050
Structure ID No	Temple
Village Name	Neelampoondi
Side (Left/Right)	Right
Distance from PCL(m)	4
Length x Breadth(m)	17.5 x 3
Proposed ROW (Equal on either side of PCL) (m)	11.5
Impact	direct impact

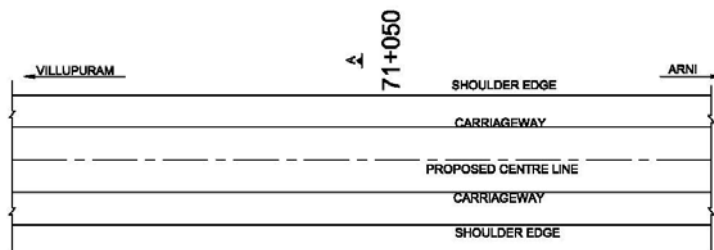
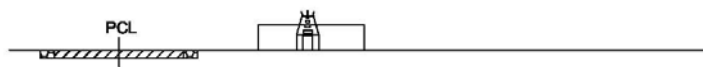

PLAN



←

MITIGATION/ENHANCEMENT

S. No.	Description	Unit	Quantity	Rate (Rs.)	Amount (Rs.)	BOQ Item No.
1	Realignment explored	nil	nil	nil	nil	nil
Total						

Chainage (km)	71+700
Structure ID No	Temple
Village Name	Neelampoondi
Side (Left/Right)	Left
Distance from PCL(m)	7
Length x Breadth(m)	1 x 2
Proposed ROW (Equal on either side of PCL) (m)	11.5
Impact	direct impact

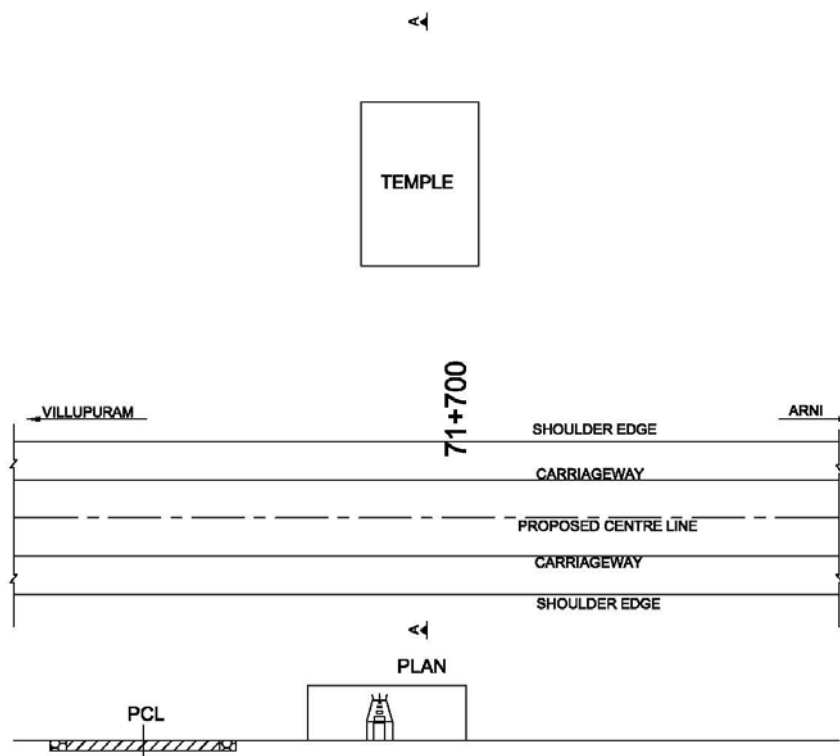

MITIGATION/ENHANCEMENT

S. No.	Description	Unit	Quantity	Rate (Rs.)	Amount (Rs.)	BOQ Item No.
1	demolition	nil	nil	nil	nil	nil
Total						

Chainage (km)	77+725	
Structure ID No	Temple	
Village Name	Kariyamangalam kut road	
Side (Right/Left)	Left	
Distance from PCL(m)	9.8	
Length x Breadth(m)	11.2 x 11	
Proposed ROW (Equal on either side of PCL) (m)	11.5	
Impact	direct impact	

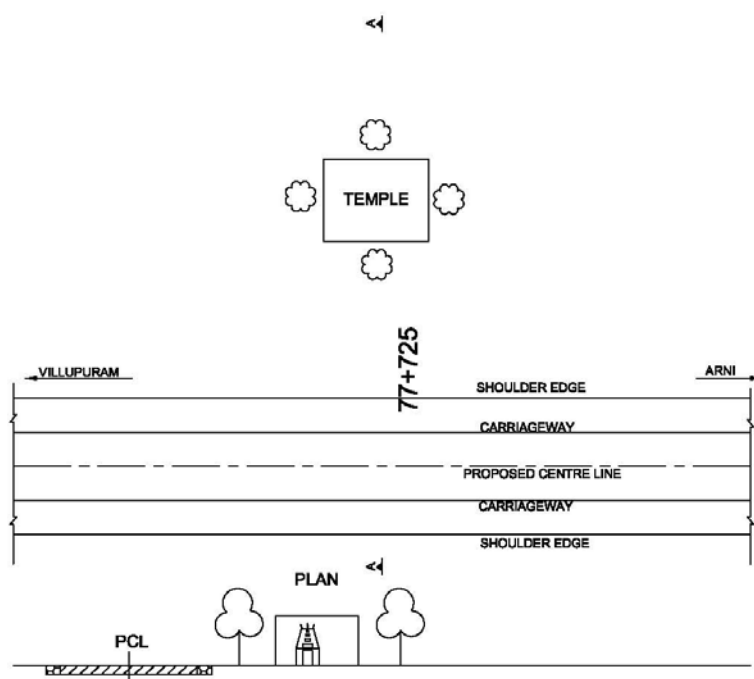

MITIGATION/ENHANCEMENT

S. No.	Description	Unit	Quantity	Rate (Rs.)	Amount (Rs.)	BOQ Item No.
1	Demolition of boundary Wall	rm	4			6.0
2	Construction of boundary Wall	rm	11.2			6.0
3	Tree Plantation	No	4			2.1
4	Gate	no	1			6.0
Total						

Chainage (km)	78+050	
Structure ID No	Temple	
Village Name	Gingee	
Side (Right/Left)	Right	
Distance from PCL(m)	2	
Length x Breadth(m)	10.5 x 21	
Proposed ROW (Equal on either side of PCL) (m)	8	
Impact	direct impact	

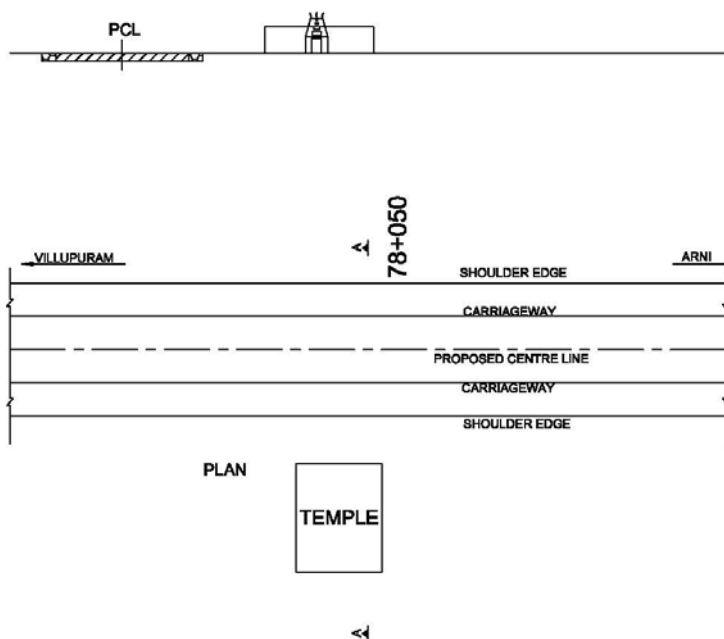

MITIGATION/ENHANCEMENT

S. No.	Description	Unit	Quantity	Rate (Rs.)	Amount (Rs.)	BOQ Item No.
1	Realignment explored	nil	nil	nil	nil	nil
Total						

Chainage (km)	81+500	
Structure ID No	Church	
Village Name	Gumiyanguttai	
Side (Right/Left)	Right	
Distance from PCL(m)	10	
Length x Breadth(m)	29.5 x 72.5	
Proposed ROW (Equal on either side of PCL) (m)	11.5	
Impact	direct impact	

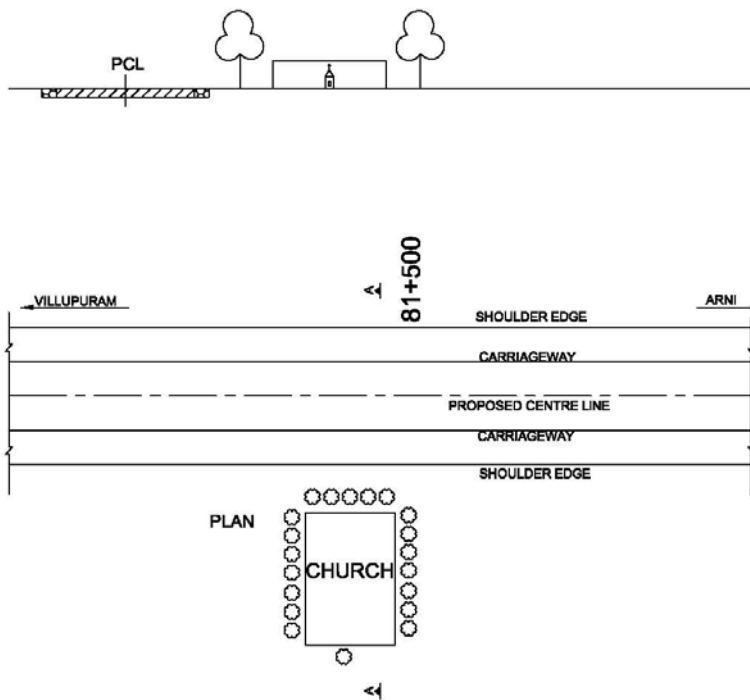

MITIGATION/ENHANCEMENT

S. No.	Description	Unit	Quantity	Rate (Rs.)	Amount (Rs.)	BOQ Item No.
1	Demolition of boundary Wall	rm	32.5			6.0
2	Construction of boundary Wall	rm	29.5			6.0
3	Tree Plantation	No	20			2.1
4	Gate	no	1			6.0
Total						

Chainage (km)	82+600
Structure ID No	Temple
Village Name	Appampattu
Side (Right/Left)	Right
Distance from PCL(m)	6.5
Length x Breadth(m)	5 x 8
Proposed ROW (Equal on either side of PCL) (m)	11.5
Impact	direct impact

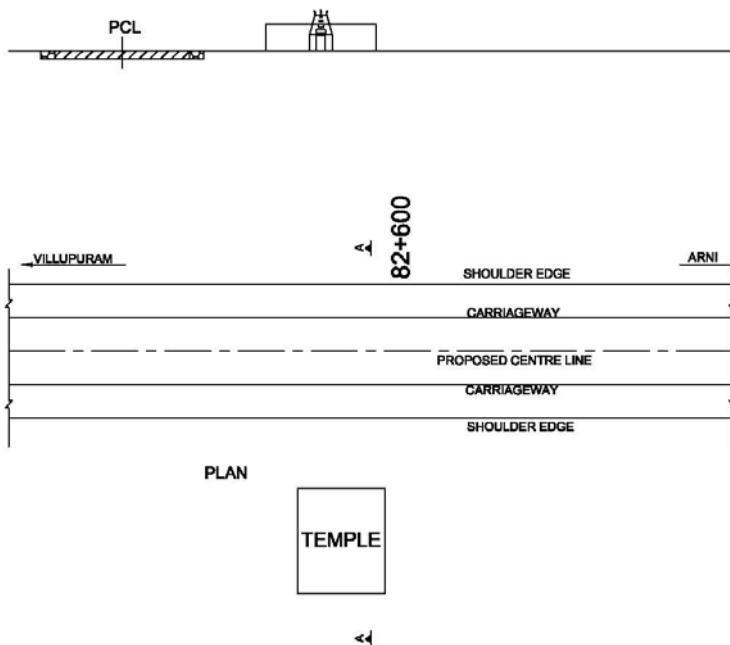

MITIGATION/ENHANCEMENT

S. No.	Description	Unit	Quantity	Rate (Rs.)	Amount (Rs.)	BOQ Item No.
1	Realignment explored	nil	nil	nil	nil	nil
Total						

Chainage (km)	84+675
Structure ID No	Temple
Village Name	Appampattu
Side (Right/Left)	Right
Distance from PCL(m)	9
Length x Breadth(m)	3 x 4.5
Proposed ROW (Equal on either side of PCL) (m)	11.5
Impact	direct impact

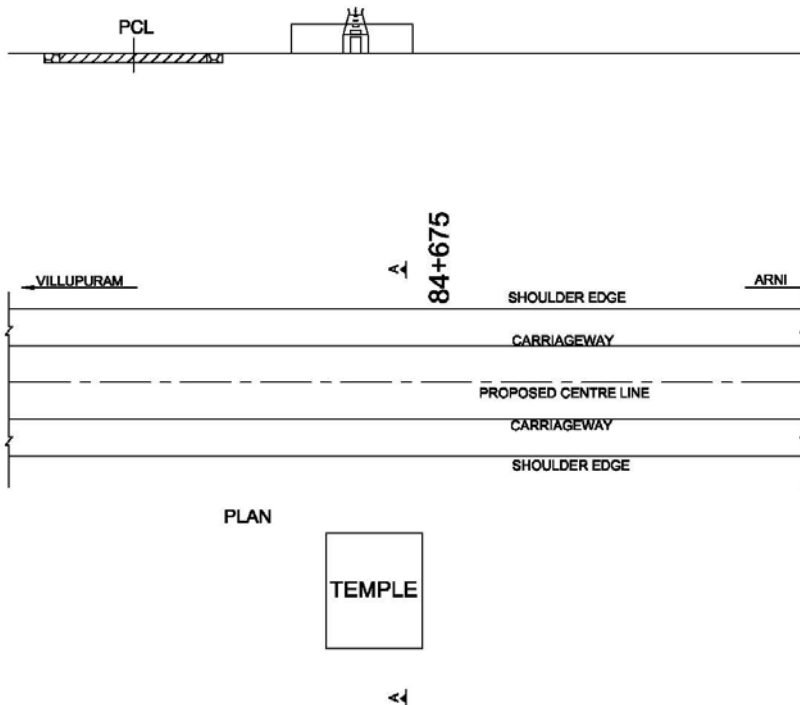

MITIGATION/ENHANCEMENT

S. No.	Description	Unit	Quantity	Rate (Rs.)	Amount (Rs.)	BOQ Item No.
1	demolition	nil	nil	nil	nil	nil
Total						

Chainage (km)	85+425	
Structure ID No	Temple	
Village Name	Kavarai	
Side (Right/Left)	Right	
Distance from PCL (m)	10.5	
Length x Breadth (m)	6.5 x 7	
Proposed ROW (Equal on either side of PCL) (m)	11.5	
Impact	direct impact	

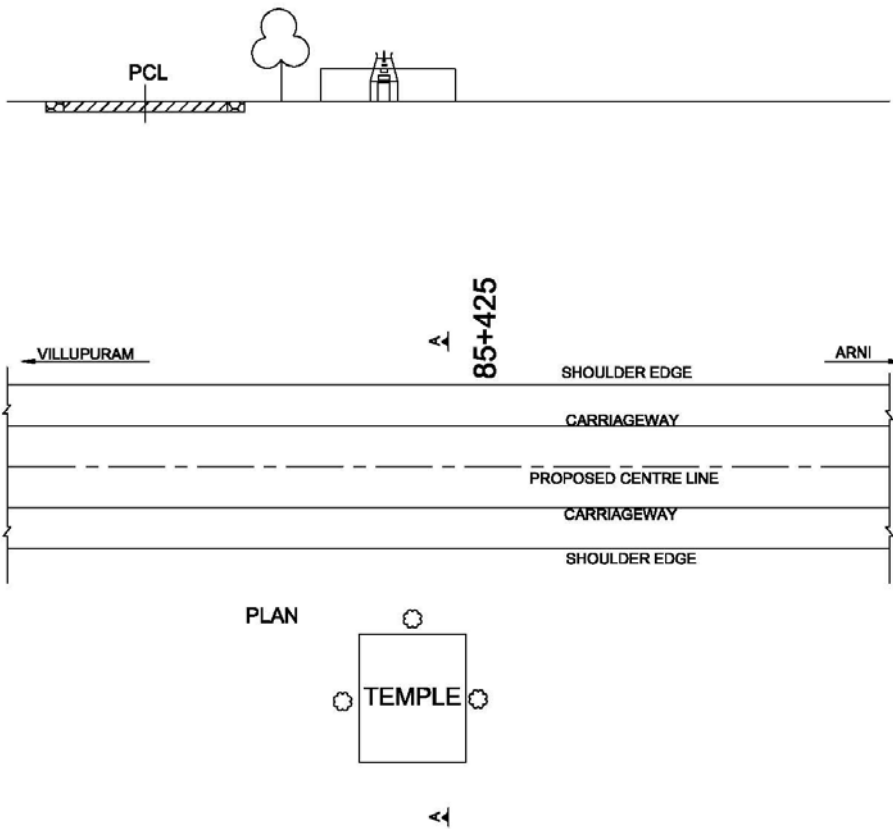

MITIGATION/ENHANCEMENT

S. No.	Description	Unit	Quantity	Rate (Rs.)	Amount (Rs.)	BOQ Item No.
1	Demolition of boundary Wall	rm	8.5			6.0
2	Construction of boundary Wall	rm	6.5			6.0
3	Tree Plantation	No	3			2.1
4	Gate	no	1			6.0
Total						

Chainage (km)	85+650
Structure ID No	Temple + Bus stop
Village Name	Kavarai
Side (Right/Left)	Right
Distance from PCL (m)	6
Length x Breadth (m)	1 x 1, 6 x 3
Proposed ROW (Equal on either side of PCL) (m)	11.5
Impact	direct impact

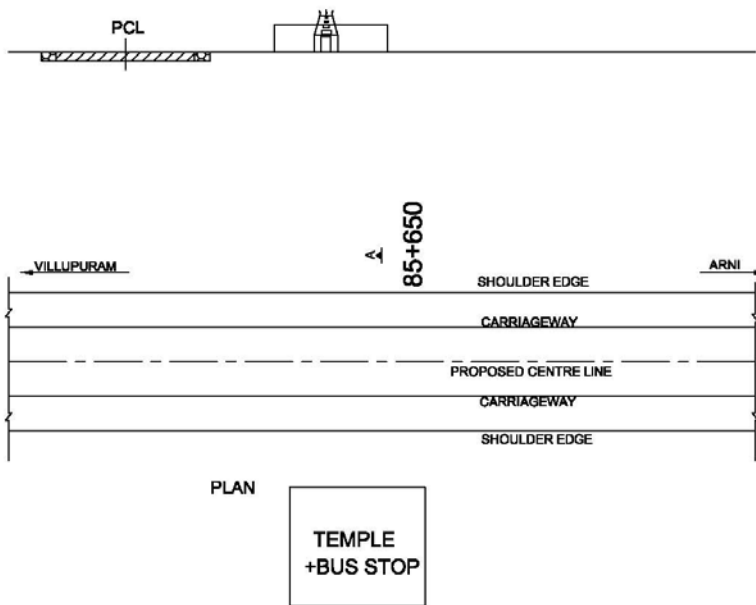

MITIGATION/ENHANCEMENT

S. No.	Description	Unit	Quantity	Rate (Rs.)	Amount (Rs.)	BOQ Item No.
1	demolition	nil	nil	nil	nil	nil
Total						

Chainage (km)	88+425	
Structure ID No	Church	
Village Name	Palappattu	
Side (Right/Left)	Left	
Distance from PCL (m)	8.4	
Length x Breadth (m)	1.5 x 1.5	
Proposed ROW (Equal on either side of PCL) (m)	11.5	
Impact	direct impact	

<4

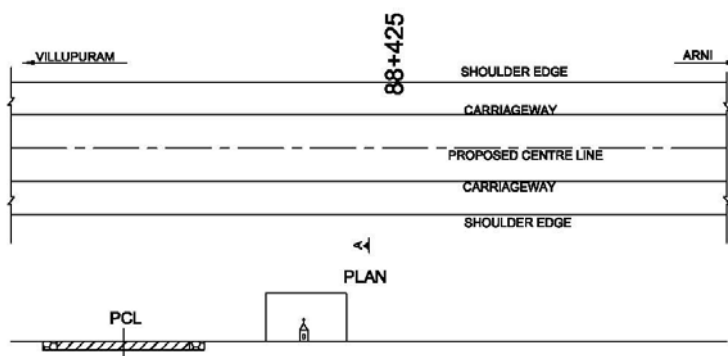

MITIGATION/ENHANCEMENT

S. No.	Description	Unit	Quantity	Rate (Rs.)	Amount (Rs.)	BOQ Item No.
1	demolition	nil	nil	nil	nil	nil
Total						

Chainage (km)	89+200	
Structure ID No	Church	
Village Name	Ottampattu	
Side (Right/Left)	Left	
Distance from PCL (m)	8.5	
Length x Breadth (m)	6.5 x 6.5	
Proposed ROW (Equal on either side of PCL) (m)	11.5	
Impact	direct impact	

<4

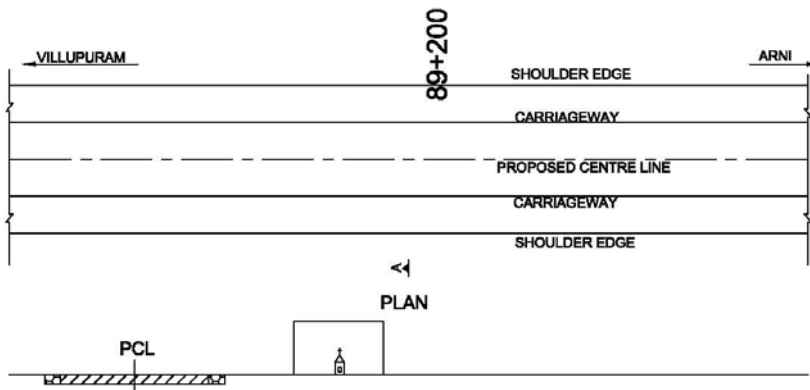

MITIGATION/ENHANCEMENT

S. No.	Description	Unit	Quantity	Rate (Rs.)	Amount (Rs.)	BOQ Item No.
1	Shed demolition	nil	nil	nil	nil	nil
Total						

Chainage (km)	97+028	
Structure ID No	Temple	
Village Name	Arsalapuram	
Side (Right/Left)	Right	
Distance from PCL (m)	3.5	
Length x Breadth (m)	1 x 1	
Proposed ROW (Equal on either side of PCL) (m)	11.5	
Impact	direct impact	

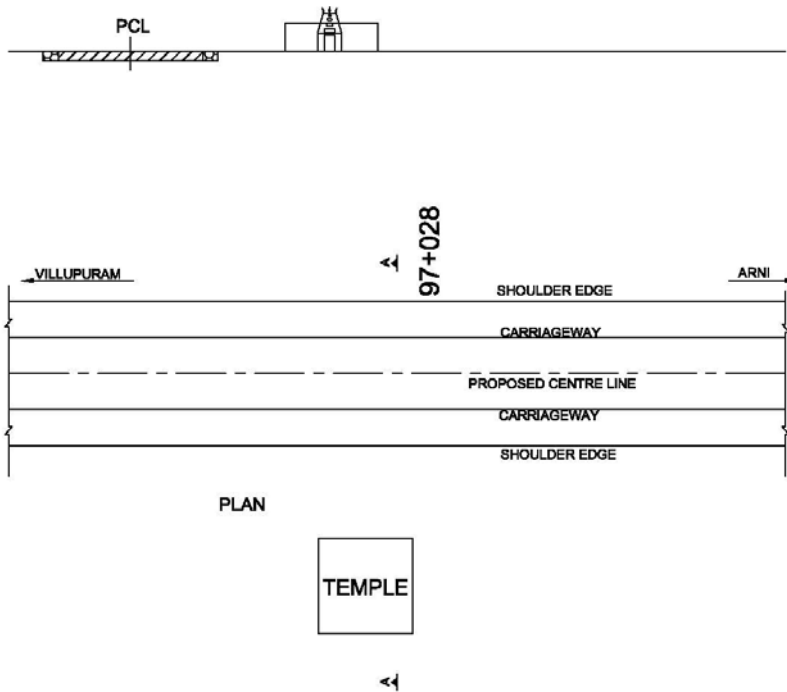

MITIGATION/ENHANCEMENT

S. No.	Description	Unit	Quantity	Rate (Rs.)	Amount (Rs.)	BOQ Item No.
1	demolition	nil	nil	nil	nil	nil
Total						

Chainage (km)	99+225	
Structure ID No	Church	
Village Name	Nembur	
Side (Right/Left)	Left	
Distance from PCL (m)	7	
Length x Breadth (m)	4.5 x 15	
Proposed ROW (Equal on either side of PCL) (m)	11.5	
Impact	direct impact	

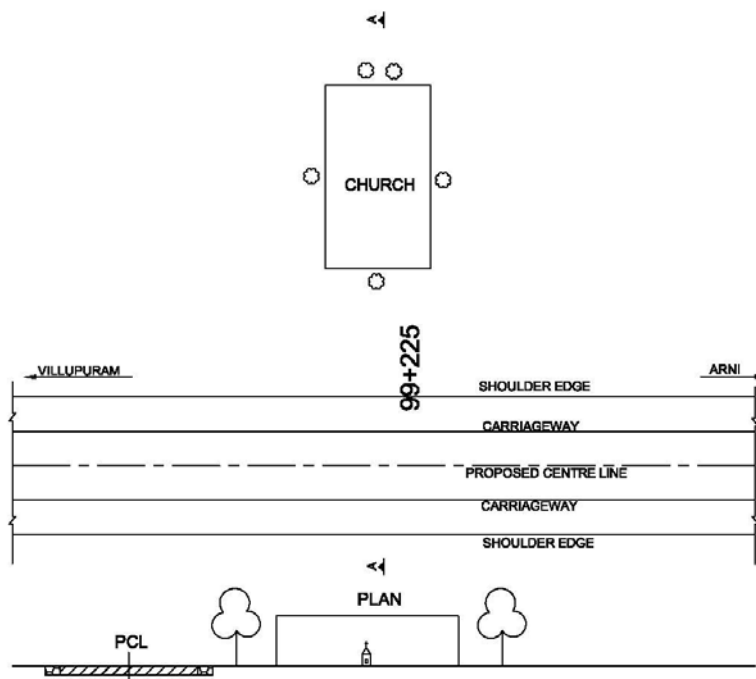

MITIGATION/ENHANCEMENT

S. No.	Description	Unit	Quantity	Rate (Rs.)	Amount (Rs.)	BOQ Item No.
1	Construction of boundary Wall	rm	4.5			6.0
2	Tree Plantation	No	5			2.1
3	Gate	no	1			6.0
Total						

Chainage (km)	99+750	
Structure ID No	Temple	
Village Name	Nandivadi	
Side (Right/Left)	Right	
Distance from PCL (m)	8.5	
Length x Breadth (m)	1 x 1	
Proposed ROW (Equal on either side of PCL) (m)	11.5	
Impact	direct impact	

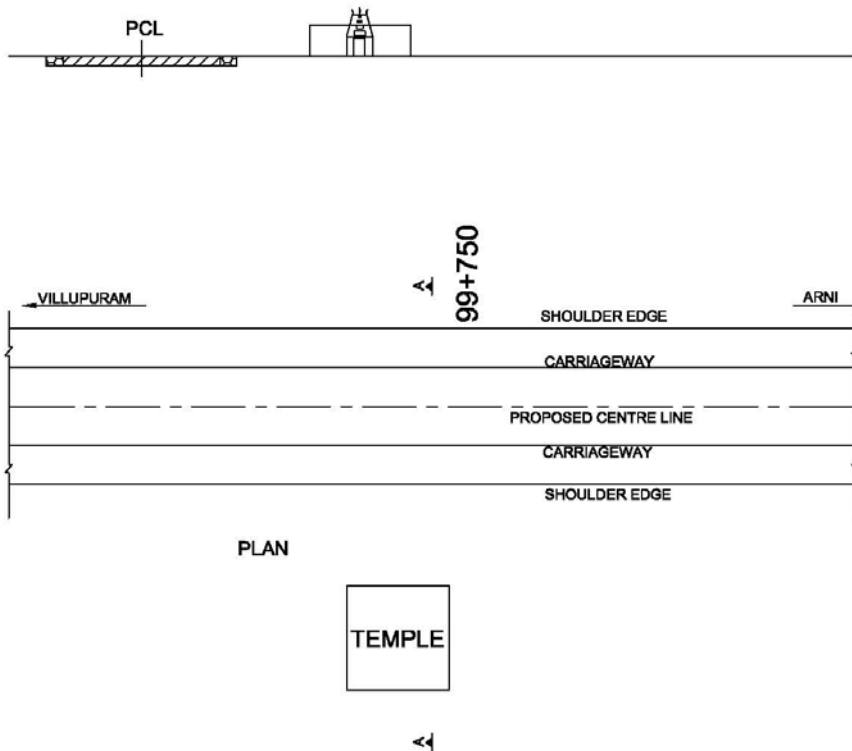

MITIGATION/ENHANCEMENT

S. No.	Description	Unit	Quantity	Rate (Rs.)	Amount (Rs.)	BOQ Item No.
1	demolition	nil	nil	nil	nil	nil
Total						

Chainage (km)	101+075	
Structure ID No	Church	
Village Name	Narsinganur	
Side (Right/Left)	Left	
Distance from PCL (m)	7	
Length x Breadth (m)	14 x 7	
Proposed ROW (Equal on either side of PCL) (m)	8	
Impact	direct impact	

<<

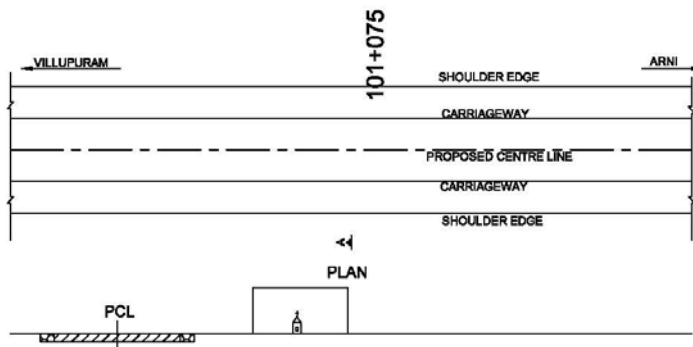

MITIGATION/ENHANCEMENT

S. No.	Description	Unit	Quantity	Rate (Rs.)	Amount (Rs.)	BOQ Item No.
1	demolition	nil	nil	nil	nil	nil
Total						

Chainage (km)	101+075	
Structure ID No	Sacred groove	
Village Name	Narsinganur	
Side (Right/Left)	Right	
Distance from PCL (m)	7.7	
Length x Breadth (m)	3 x 4	
Proposed ROW (Equal on either side of PCL) (m)	8	
Impact	direct impact	

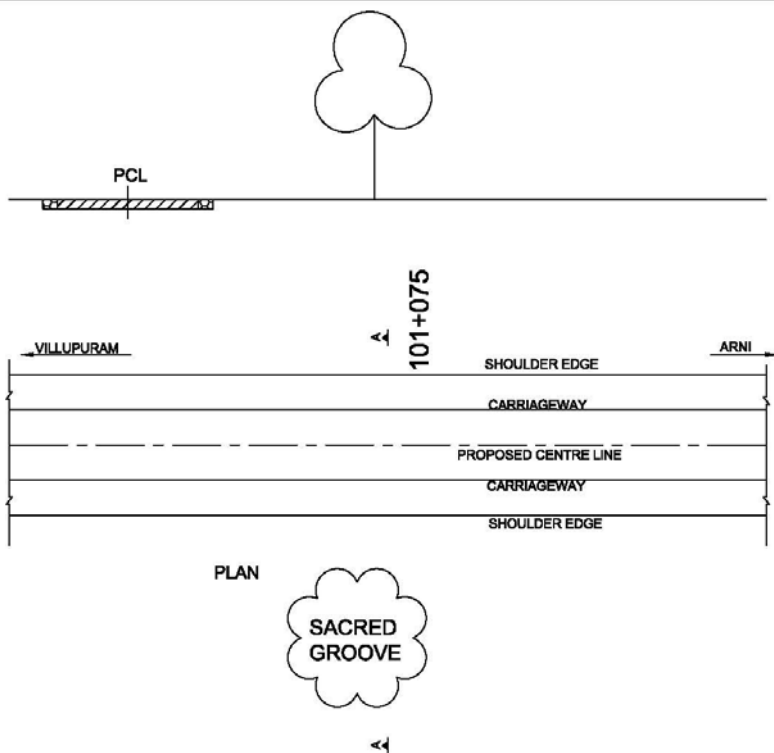

MITIGATION/ENHANCEMENT

S. No.	Description	Unit	Quantity	Rate (Rs.)	Amount (Rs.)	BOQ Item No.
1	Realignment explored	nil	nil	nil	nil	nil
Total						

Chainage (km)	101+950	
Structure ID No	Temple	
Village Name	Kanjanur	
Side (Right/Left)	Right	
Distance from PCL (m)	7	
Length x Breadth (m)	13.5 x 5.5	
Proposed ROW (Equal on either side of PCL) (m)	8	
Impact	direct impact	

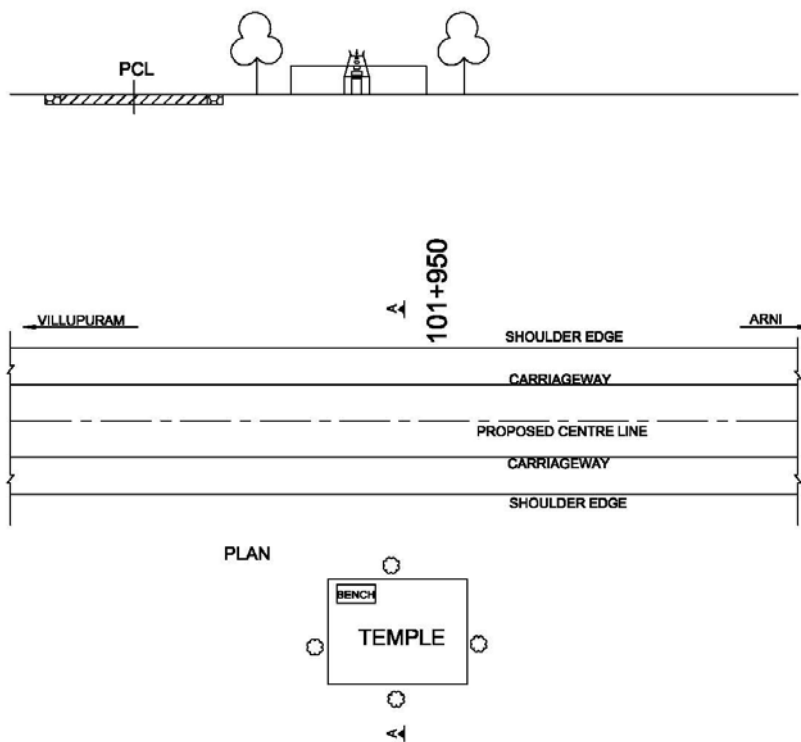

MITIGATION/ENHANCEMENT

S. No.	Description	Unit	Quantity	Rate (Rs.)	Amount (Rs.)	BOQ Item No.
1	Demolition of boundary Wall	rm	15.5			6.0
2	Construction of boundary Wall	rm	13.5			6.0
3	Seating bench	No	1			6.0
4	Tree Plantation	No	4			2.1
5	Gate	no	1			6.0
Total						

Chainage (km)	102+300	
Structure ID No	Sacred groove	
Village Name	Kanjanur	
Side (Right/Left)	Right	
Distance from PCL (m)	5	
Length x Breadth (m)	0.6 girth	
Proposed ROW (Equal on either side of PCL) (m)	8	
Impact	direct impact	

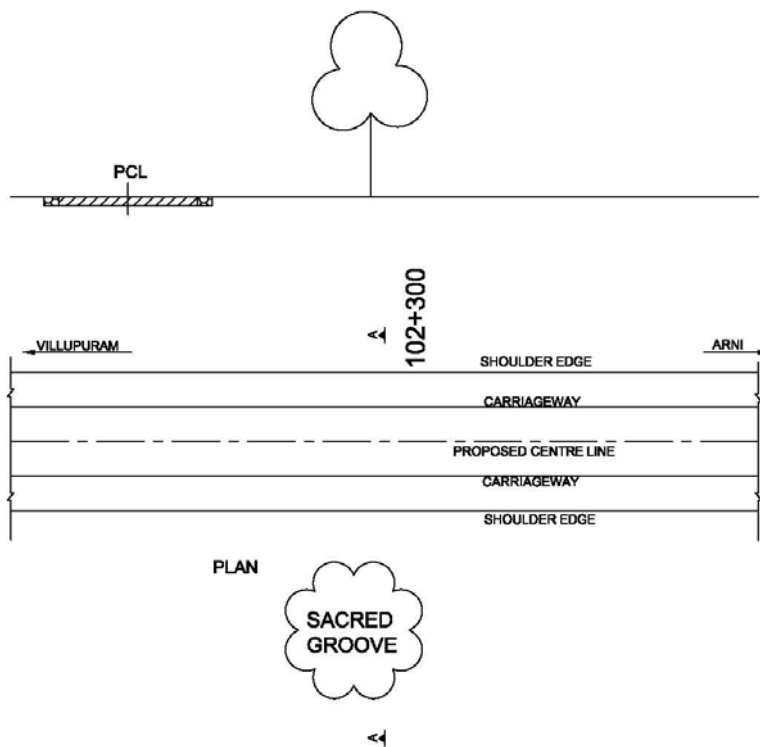

MITIGATION/ENHANCEMENT

S. No.	Description	Unit	Quantity	Rate (Rs.)	Amount (Rs.)	BOQ Item No.
1	Realignment explored	nil	nil	nil	nil	nil
Total						

Chainage (km)	103+275	
Structure ID No	Temple	
Village Name	Poondi Kannima	
Side (Right/Left)	Right	
Distance from PCL (m)	4.5	
Length x Breadth (m)	5.5 x 7	
Proposed ROW (Equal on either side of PCL) (m)	8	
Impact	direct impact	

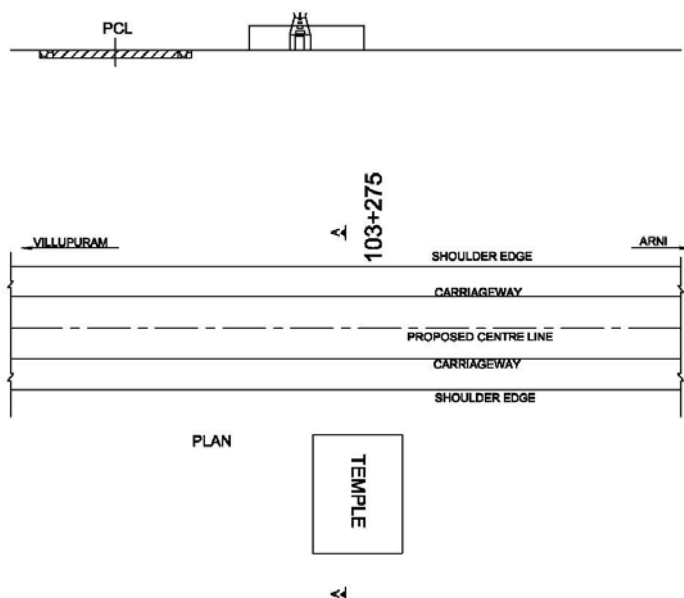

MITIGATION/ENHANCEMENT

S. No.	Description	Unit	Quantity	Rate (Rs.)	Amount (Rs.)	BOQ Item No.
1	Realignment explored	nil	nil	nil	nil	nil
Total						

Chainage (km)	107+330	
Structure ID No	Temple	
Village Name	Thumbur	
Side (Right/Left)	Right	
Distance from PCL (m)	7.5	
Length x Breadth (m)	6.5 x 10.5	
Proposed ROW (Equal on either side of PCL) (m)	8	
Impact	direct impact	

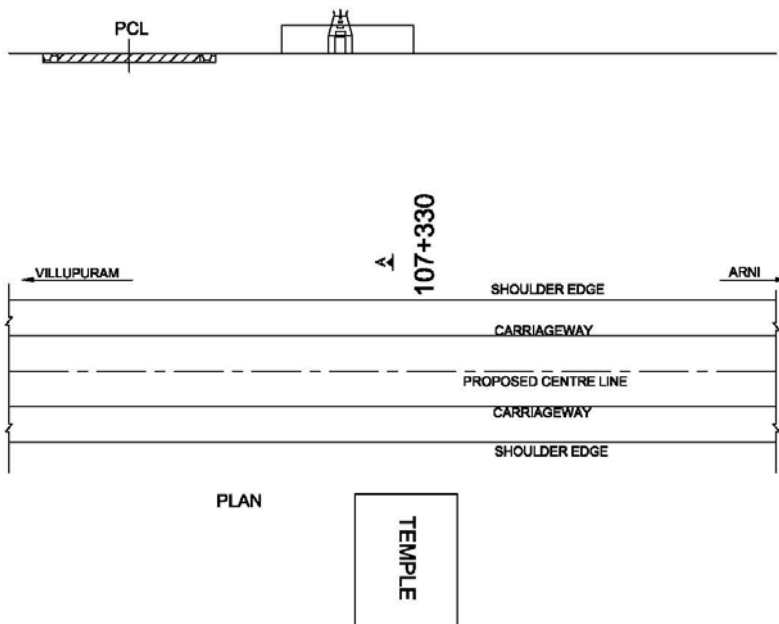

MITIGATION/ENHANCEMENT

S. No.	Description	Unit	Quantity	Rate (Rs.)	Amount (Rs.)	BOQ Item No.
1	Shed Demolition	nil	nil	nil	nil	nil
Total						

Chainage (km)	107+775
Structure ID No	Temple
Village Name	Thumbur
Side (Right/Left)	Left
Distance from PCL (m)	5
Length x Breadth (m)	3.5 x 4
Proposed ROW (Equal on either side of PCL) (m)	11.5
Impact	direct impact

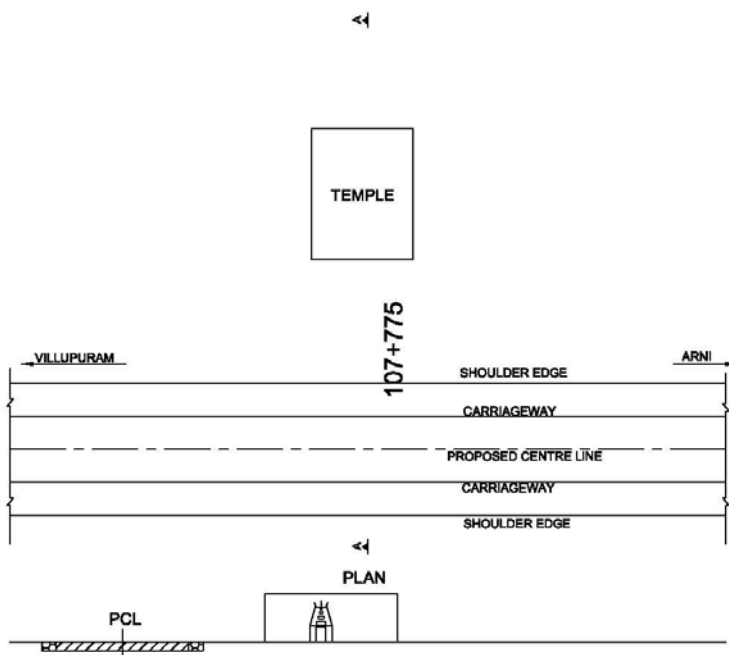

MITIGATION/ENHANCEMENT

S. No.	Description	Unit	Quantity	Rate (Rs.)	Amount (Rs.)	BOQ Item No.
1	demolition	nil	nil	nil	nil	nil
Total						

Chainage (km)	113+250	
Structure ID No	Temple	
Village Name	Muthiyalpatem	
Side (Right/Left)	Right	
Distance from PCL (m)	7.5	
Length x Breadth (m)	5 x 9	
Proposed ROW (Equal on either side of PCL) (m)	8	
Impact	direct impact	

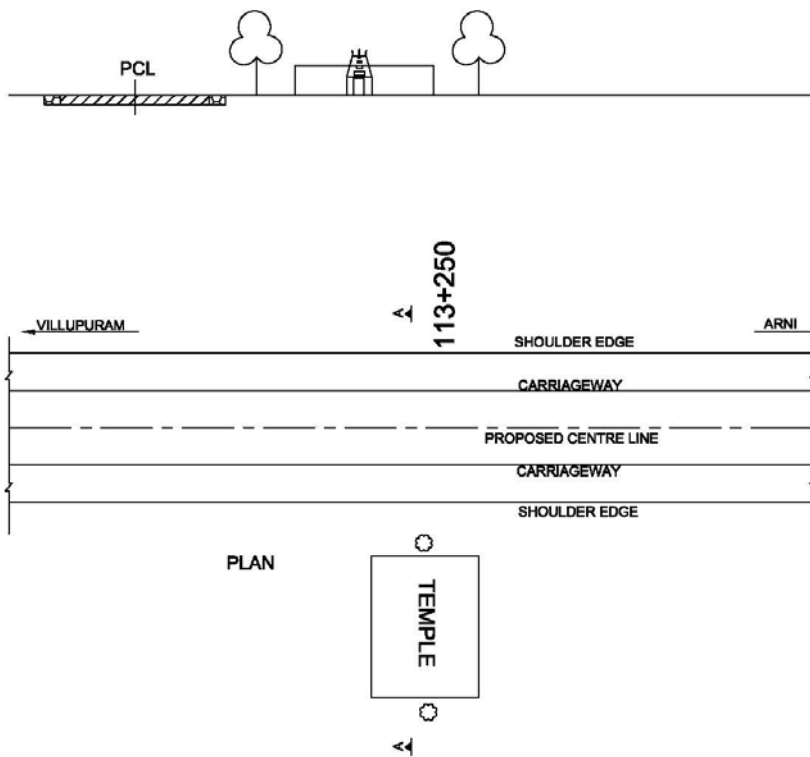

MITIGATION/ENHANCEMENT

S. No.	Description	Unit	Quantity	Rate (Rs.)	Amount (Rs.)	BOQ Item No.
1	Demolition of boundary Wall	rm	6			6.0
2	Construction of boundary Wall	rm	5			6.0
3	Tree Plantation	No	2			2.1
4	Gate	no	1			6.0
Total						

Chainage (km)	113+250	
Structure ID No	Temple (2 nos)	
Village Name	Muthiyalpatem	
Side (Right/Left)	Right	
Distance from PCL (m)	6	
Length x Breadth (m)	7.5 x 6	
Proposed ROW (Equal on either side of PCL) (m)	8	
Impact	direct impact	

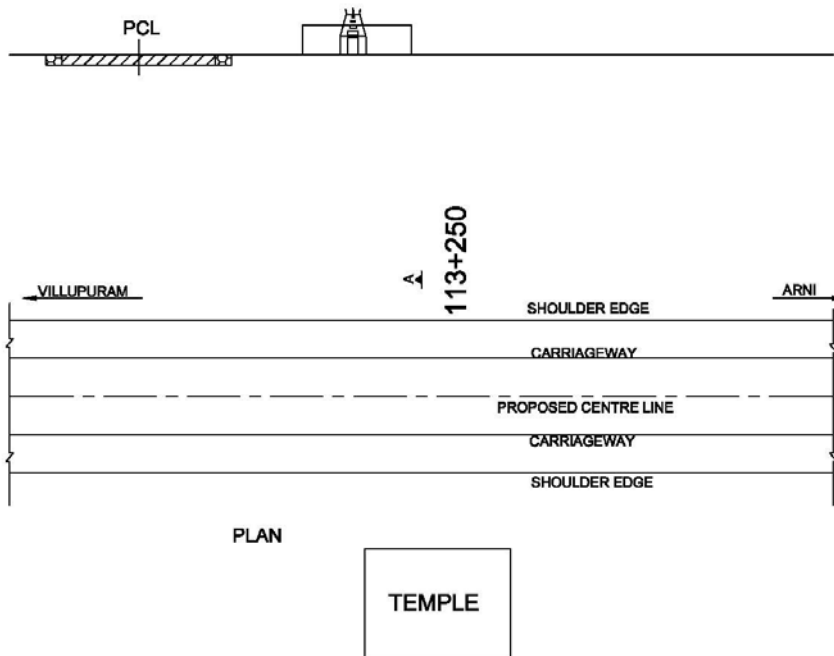

MITIGATION/ENHANCEMENT

S. No.	Description	Unit	Quantity	Rate (Rs.)	Amount (Rs.)	BOQ Item No.
1	Shed demolished	nil	nil	nil	nil	nil
Total						

Chainage (km)	113+850
Structure ID No	Temple
Village Name	Ayanampali
Side (Right/Left)	Right
Distance from PCL (m)	6
Length x Breadth (m)	3.5 x 3.5
Proposed ROW (Equal on either side of PCL) (m)	8
Impact	direct impact

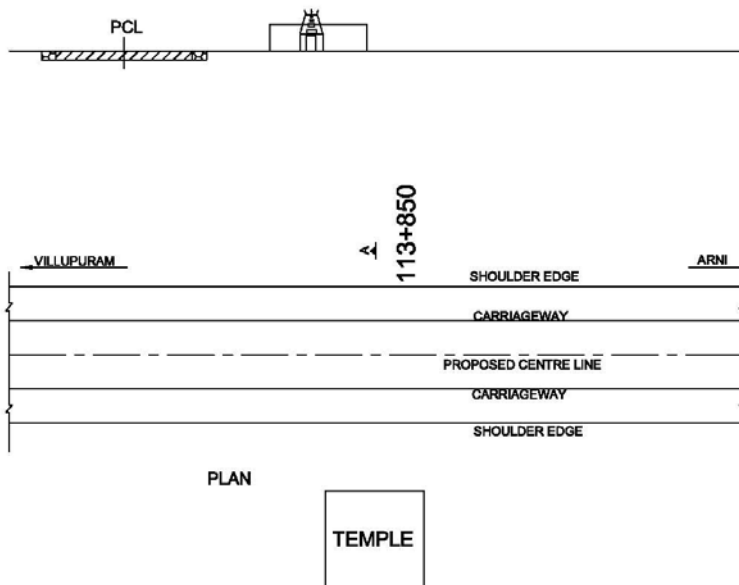

MITIGATION/ENHANCEMENT

S. No.	Description	Unit	Quantity	Rate (Rs.)	Amount (Rs.)	BOQ Item No.
1	Realignment explored	nil	nil	nil	nil	nil
Total						

ANNEXURE 3.56 CULTURAL PROPERTIES REHABILITATION MEASURES

The project needs to develop measures for the rehabilitation of cultural properties that will be affected by the road improvement programme. This could be made a part of the broad R&R Principle and Policy Framework. The Environmental Budget within the EMP will undertake the environmental enhancement where as any land acquisition and rehabilitation will be part of the Resettlement Action Plan. The TNRSP has been guided by the Bank's Draft Operational Policy 4.11, which exclusively deals with the cultural properties, in its handling of the affected cultural properties due to the project. Further, as desired by the Bank, this section of the EMP and RAP has been prepared as a separate safeguard measures exclusively for the TNRSP.

What Does Cultural Property Mean?

The United Nations term "Cultural Property" includes sites having archaeological (prehistoric), palaeontological, historical, religious, and unique natural values. Cultural Property, therefore, encompasses remains left by previous inhabitants, for example, shrines, and battlegrounds) and unique natural environmental features such as canyons and waterfalls. The rapid loss of cultural property in many countries is irreversible and often unnecessary. Detailed background information on all aspects of this note are contained in the technical paper of the same title, available from the office of Environmental and Scientific Affairs, Project Policy Department of UN, which is ready to provide assistance on request.
Source: World Bank Draft OP 4.11

1. TYPES OF RELIGIOUS PROPERTIES IDENTIFIED IN THE PROJECT LOCATION

The environmental and social surveys and the detailed social impact studies have identified all cultural properties (total 14 Nos) that will be affected by the SH 58 road widening. Their magnitude of being affected widely varies. The following types of cultural properties are found on the project roads:

- 1 Temple
- 2 Church
- 3 Mosque
- 4 Shrines of all the three major religions
- 5 Tree shrines/sacred groves

Except the tree shrines, the others are not strictly "common property" because they are owned and managed by their respective registered "Society" or "Trust". Few cultural properties have encroached on the Government land (need to wait till RAP is competing). Other properties are affected in terms of losing boundary walls or land.

2. DEFINITIONS

Shrines are usually small structures, located in the vicinity of the main religious structure associated with all the three major religions of the State. The shrines usually serve the purpose of helping the road users obtain a quicker religious service, besides indicating the larger presence of the religious community in the locality.

The shrines are a most important part of any place of worship. Normally a small shrine develops to a bigger place of worship with earlier shrine remaining as the most important part of the property.

Temples are Hindu places of worship. There are private as well as community temples. Most of the

temples are different from one another by way of age and idols (Shiva, Vishnu, Krishna etc). In a majority of the cases, the location has specific significance. Because of the same reason temples are usually located away from the Roads.

Churches are Christian places of worship. There are no private Churches. The churches usually belong to different groups within Christianity (Catholic, Marthoma, Syrian, Pentecostal, etc). Except few cases the location has no specific significance for a church.

Mosques are the places of worship of the Muslims. There are Sunny Mosques and Mujahiddin mosques. With regard to the rehabilitation policy, all mosques can be treated as belonging to the same type. There are no known location specific mosques in the project location.

Tree shrines are usually associated with the Hindus. There are a few tree shrines located along the project roads. People worship the idols installed at the base of the trees as well as the trees. These trees have a special significance to the local community, which will usually oppose the removal of such tree shrines. The landscaping would be ideal. This will require extensive community consultation.

Sacred groves are also usually associated with the Hindus. For this purpose they preserve a small forest, known as sacred groves. This represents the close association of man with nature. Usually, landscaping would be ideal for the sacred groves.

Direct Impacts: The direct impacts to the cultural properties are of the following category.

- 1 Only Compound wall affected
- 2 Compound wall and part of the compound affected
- 3 Part of structure affected
- 4 Sanctum sanatorium affected – can be categorized as the complete structure affected
- 5 Only land affected
- 6 Complete cultural property affected
- 7 Loss of access/entrance, if the existing access is from the project roadside.

Project Approach: In all cases, the mitigation actions are framed unique to that particular situation with respect to the available space, the unique characteristics of the religious structure affected and the local public and religious judgment. In other words, the project policy is unique to consider the widely varying situations for each cultural property.

Impact Mitigation: The loss of land and assets of the cultural properties will be treated on par with the loss of other land and assets for the purpose of compensation and assistance. However, the project will, in addition, strive to enhance benefits to the affected cultural properties in consultation with their respective management/ Owners.

The Project has a clear strategy to take people and affected parties in to confidence before taking any decision on shifting of structures especially religious structures. In general there would not be any involuntary shifting or relocation especially in the case of cultural properties. An outline benefits enhancement for the cultural properties is shown in the following table.

STRATEGY FOR RESTORATION, RELOCATION OR RECONSTRUCTION OF CULTURAL

PROPERTIES

SL NO.	EXTENT OF IMPACT ON CULTURAL PROPERTIES	IF CONSULTATION CONDUCTED CONSENSUS OBTAINED	BENEFIT ENHANCEMENT
1	Only Compound wall and land beneath affected	Reconstruction of wall parallel to the present compound wall. Loss of land compensated.	Access/entrance provided through one of the sides
2	Compound wall and part of compound affected	Reconstruction of wall parallel to the existing wall. Loss of land compensated. If land is available adjacent to the property, will be purchased.	- Do -
3	Structure affected	Alternate structure constructed and all pre-status restored.	- Do -
4	Sanctum sanctorum affected	Complete structure reconstructed and all pre-status restored.	- Do -
5	Only land affected	Alternate land provided, preferably, if available, adjacent to the existing location.	-Do-
6	Complete cultural property affected	Relocation of site identified by the cultural property authorities and rebuilding of the property.	-Do-

3. OTHER IMPACTS TO CULTURAL PROPERTIES INCLUDE:

Indirect/Induced impacts: The construction of road or realignments or bypasses sometime will result in induced impacts obstructing the cultural properties in various ways. In the instances of such events the highway authority will assist through consultation and other means (Highway Protection Act, 2000) restoring the importance of the shrine. This will be mostly applicable along the new alignments.

4. CULTURAL PROPERTY REHABILITATION ACTION PLAN

The Rehabilitation Action Plan include environmental enhancement, design changes to save the structure from being affected. It was also planned to make design changes or adjustments to save the cultural properties from being affected.

5. CULTURAL PROPERTY IMPACT ASSESSMENT, MITIGATION AND ENHANCEMENT PLAN

The cultural properties that will be affected by the SH 58 widening are shown table below.

List of religious/culturaland othercommunity assets and mitigation

Sl. No.	Chainage (Km.)	Name of Common Property	Location (Left / Right)	Distance from PCL (m)	Impact	Mitigation/Enhancement (As per Appendix 8.14 & Generic enhancement)
1	29.300	Temple	Left	7	Direct Impact	Front footpath demolished
2	29.700	Mosque	Right	4	Direct Impact	Boundary Wall D
3	29.800	Mosque	Left	6	Direct Impact	Gate D
4	29.900	Temple (4 nos)	Right	6.5	Direct Impact	Front footpath D
5	30.000	Temple	Right	5	Direct Impact	D
6	30.100	Temple	Right	5	Direct Impact	Realignment Explored
7	30.100	Temple	Right	6	Direct Impact	Realignment Explored

Sl. No.	Chainage (Km.)	Name of Common Property	Location (Left / Right)	Distance from PCL (m)	Impact	Mitigation/Enhancement (As per Appendix 8.14 & Generic enhancement)
8	30.600	Statue	Left	10s	Direct Impact	D
9	31.500	Temple	Right	5.5	Direct Impact	Boundary Wall shifted
10	32.900	Temple	Right	7	Direct Impact	Boundary Wall shifted
11	36.750	Temple	Right	11	Direct Impact	Boundary Wall shifted
12	37.650	Temple	Right	9	Direct Impact	Wall D&R
13	37.875	Temple	Right	8.5	Direct Impact	Realignment Explored
14	41.450	Temple	Right	10.5	Direct Impact	Temple mandapam D
15	42.575	Temple	Right	7	Direct Impact	Gate D&R
16	43.525	Temple	Left	6.5	Direct Impact	Realignment Explored
17	58.425	Temple	Left	10.5	Direct Impact	Gate D
18	85.650	Temple	Left	6	Direct Impact	D
19	88.425	Church	Right	8.4	Direct Impact	D
20	89.200	Church	Right	8.5	Direct Impact	Shed D
21	97.028	Temple	Left	3.5	Direct Impact	Shifted D
22	99.225	Church	Right	7	Direct Impact	Boundary fencing shifted
23	99.750	Temple	Left	8.5	Direct Impact	Shifted D
24	101.075	Church	Right	7	Direct Impact	Shifted D
25	101.075	Sacred Groove	Left	7.7	Direct Impact	Realignment Explored
26	101.950	Temple	left	7	Direct Impact	Boundary wall D&R
27	103.275	Sacred Groove	Left	5	Direct Impact	Realignment Explored
28	103.275	Temple	Left	4.5	Direct Impact	Realignment Explored
29	107.330	Temple	Left	7.5	Direct Impact	Shed demolished
30	107.775	Temple	Right	5	Direct Impact	Shifted
31	113.225	Temple	Left	7.5	Direct Impact	Boundary wall D&R
32	113.250	Temple	Left	6	Direct Impact	Temple shed wall D
33	113.850	Temple	Left	6	Direct Impact	Realignment Explored
34	84.675	Temple	Left	9	Direct Impact	Shifted D
35	77.725	Temple	Right	9.8	Direct Impact	Shifted D
36	78.050	Temple	Left	2	Direct Impact	Realignment Explored
37	82.600	Temple	Left	6.5	Direct Impact	Realignment Explored
38	81.500	Church	Left	10	Direct Impact	Boundary wall shifted
39	44.100	Temple	Right	7.7	Direct Impact	Shifted D
40	71.700	Temple	Left	7	Direct Impact	Shifted D
41	45.700	Temple	Right	6.5	Direct Impact	Realignment Explored
42	46.375	Temple	Left	9.8	Direct Impact	Shifted D
43	48.650	Temple	Right	7.7	Direct Impact	Shifted D
44	52.450	Temple	Right	7.7	Direct Impact	Boundary wall shifted
45	62.600	Temple	Right	5	Direct Impact	Shifted D
46	65.600	Temple	Right	7	Direct Impact	Realignment Explored
47	65.880	Temple	Right	8	Direct Impact	Boundary wall shifted D&R
48	67.350	Temple	Right	6.3	Direct Impact	Front footpath demolished D

Sl. No.	Chainage (Km.)	Name of Common Property	Location (Left / Right)	Distance from PCL (m)	Impact	Mitigation/Enhancement (As per Appendix 8.14 & Generic enhancement)
49	67.862	Temple	Right	8.5	Direct Impact	Boundary wall shifted
50	71.050	Temple	Right	4	Direct Impact	Realignment Explored
51	65.500	Church	left	6.5	Direct Impact	Realignment Explored
52	66.970	Statue	Right	7.5	Direct Impact	Shifted D
53	66.300	Grave yard	Left	7	Direct Impact	Realignment Explored
54	66.200	Grave yard	Left	10.5	Direct Impact	Realignment Explored
55	68.350	Grave yard	Left	7	Direct Impact	Realignment Explored

The team found out three distinct cases for impact mitigation. These are

Design changes made to save cultural properties: Accordingly most of the cultural properties have been saved.

Relocation necessary: In few cases some land acquisition will also be necessary.

Environmental Enhancement and landscaping:At least in many cases cultural property enhancement measures are necessary.

ANNEXURE 8.1: GUIDELINES FOR MONITORING PROGRAM

Environmental Monitoring Plan

To ensure the effective implementation of the EMP, it is essential that an effective monitoring programme be designed and carried out. Broad objectives of the monitoring programme are:

- To evaluate the performance of mitigation measures proposed in the EMP
- To suggest improvements in the management plans, if required
- To satisfy the statutory and community obligations

The monitoring programme contains monitoring plan for all performance indicators, reporting formats and necessary budgetary provisions. Monitoring plan for performance indicators and reporting system is presented in the following sections.

Performance Indicators

The Performance Indicators and monitoring plans prepared for *Project Implementation* are presented in Table.

Performance Indicators for Project Implementation

S. No.	Indicator	Details	Stage
A	Environmental Condition Indicators and Monitoring Plan		
1	Air Quality	The parameters to be monitored, frequency and duration of monitoring as well as the locations to be monitored will be as per the Monitoring Plan prepared	Pre Construction
			Construction
			Operation
2	Noise Levels		Pre Construction
			Construction
			Operation
3	Water Quality		Pre Construction
			Construction
			Operation
4	Soil Quality		Pre Construction
			Construction
			Operation
B	Environmental Management Indicators and Monitoring Plan		
1	Construction Camps	Location of construction camps have to be identified and parameters indicative of environment in the area has to be reported	Pre-construction
2	Borrow Areas	Location of borrow areas have to be identified and parameters indicative of environment in the area has to be reported.	Pre-construction
3	Tree Cutting	Progress of tree removal marked for cutting is to be reported	Pre-construction
4	Tree Plantation	Progress of measures suggested as part of the Strategy is to be reported	Construction
C	Management & Operational Performance Indicators		

S. No.	Indicator	Details	Stage
1	Survival Rate of Trees	The number of trees surviving during each visit will be compared with the number of saplings planted	Operation
2	Status Regarding Rehabilitation of Borrow Areas	The PU will undertake site visits to determine how many borrow areas have been rehabilitated in line with the landowner's request and to their full satisfaction.	Operation
3	Soil Erosion	Visual monitoring and operation inspection of embankments will be carried out once in three months.	Operation

Monitoring Parameters and Standards

The Environmental monitoring of the parameters involved and the threshold limits specified are discussed below:

Ambient Air Quality Monitoring (AAQM)

The air quality parameters viz: Sulphur Dioxide (SO₂), Particulate Matter (PM₁₀) & Particulate Matter (PM_{2.5}), Oxides of Nitrogen (NO_x), Carbon Monoxide (CO), Hydro-Carbons (HC), shall be regularly monitored at identified locations from the start of the construction activity. The air quality parameters shall be monitored in accordance with the National Ambient Air Quality Standards as given in **Table 1.2A**. The duration and the pollution parameters to be monitored and the responsible institutional arrangements are detailed out in the Environmental Monitoring Plan **Table 1.3** and specific details in chapter on baseline environment.

Table 1.2A National Ambient Air Quality Standards

Pollutant	Time Weighted Average	Industrial, Residential, Rural & Other Area	Ecologically Sensitive Area (notified by Central Government)
Sulphur Dioxide (SO ₂), µg/ m ³	Annual	50	20
	24 Hours**	80	80
Nitrogen Dioxide as NO ₂ , µg/ m ³	Annual	40	30
	24 Hours**	80	80
Particulate Matter (size less than 10µm) or PM ₁₀ µg/ m ³	Annual	60	60
	24 Hours**	100	100
Particulate Matter (size less than 2.5µm) or PM _{2.5} µg/ m ³	Annual *	40	40
	24 Hours**	60	60
Ozone (O ₃) µg/ m ³	8 hours**	100	100
	1 Hours**	180	180
Lead (Pb) µg/ m ³	Annual *	0.50	0.50
	24 Hours**	1.0	1.0
Carbon Monoxide (CO) mg/m ³	8 Hours**	02	02
	1 Hour**	04	04
Ammonia (NH ₃) µg/ m ³	Annual *	100	100
	24 Hours**	400	400
Benzene (C ₆ H ₆) µg/ m ³	Annual *	05	05

Benzo (a) pyrene (BaP) particulate phase only ng/m ³	Annual *	01	01
Arsenic (AS) ng/m ³	Annual *	06	06
Nickel (Ni) ng/m ³	Annual *	20	20

Source: Central Pollution Control Board Notification dated 18th November 2009

* Annual arithmetic mean of minimum 104 measurements in a year at a particular site taken twice a week hourly at uniform intervals

** 24 hourly or 08 hourly or 01 hourly monitored values, as applicable, shall be complied with 98% of the time in a year. 2% of the time, they may exceed the limits but not on two consecutive days of monitoring.

Noise Quality Monitoring

The noise levels shall be monitored at already designated locations in accordance with the Ambient Noise Quality standards given in **Table 1.2B**. The duration and the noise pollution parameters to be monitored and the responsible institutional arrangements are detailed in the Environmental Monitoring Plan **Table 1.3** and specific details in chapter on baseline environment.

Table 1.2B National Standard of Noise

Category of Zones	Leq in dB(A)	
	Day*	Night
Industrial	75	70
Commercial	65	55
Residential	55	45
Silence Zone **	50	40

Source: MoEF

1. Day time shall mean from 6.00 a.m. to 10.00 p.m.
2. Night time shall mean from 10.00 p.m. to 6.00 a.m. not less than 100 metres around hospitals, educational institutions and courts. The silence zones are zones which are declared as such by the competent authority.
3. Mixed categories of areas maybe declared as one of the four above mentioned categories by the competent authority.

Water Quality Monitoring

Water quality parameters such as pH, BOD, COD, DO coliform count, total suspended solids, total dissolved solids, Iron, etc. shall be monitored at all identified locations during the construction stage as per standards prescribed by Central Pollution Control Board and Indian Standard Drinking water specifications IS 10500, 2012, presented in **Table 1.2C**. The duration and the pollution parameters to be monitored and the responsible institutional arrangements are detailed out in the Environmental Monitoring Plan **Table 1.3** and specific details in chapter on baseline environment.

Table 1.2C: National Standard of Water

S. No.	Characteristic	Requirement (Acceptable Limit)	Permissible limit in the absence of alternate source	Remarks
Essential Characteristics				
1	Colour, Hazen units, Max	5	15	Extended to 15 only, if toxic substances are not suspected in absence of alternate source
2	Odour	Agreeable	Agreeable	a) Test cold and when heated b) Test at several dilutions
3	pH Value	6.5 to 8.5	No relaxation	-
4	Taste	Agreeable	Agreeable	Test to be conducted only after safety has been established
5	Turbidity NTU, max	1	5	-
6	Total dissolved solids, mg/l, Max	500	2000	-
7	Aluminium (as Al), mg/l Max	0.03	0.2	-
8	Ammonia (as total ammonia-N), mg/l Max	0.5	No relaxation	-
9	Anionic detergents (as MBAS), mg/l, Max	0.2	1.0	-
10	Barium (as Ba), mg/l, max	0.7	No relaxation	-
11	Boron (as B), mg/l Max	0.5	1.0	-
12	Calcium (as Ca) mg/l, Max	75	200	-
13	Chloramines (as Cl ₂), mg/l, Max	4.0	No relaxation	-
14	Chloride (as Cl) mg/l, Max	250	1000	-
15	Copper (as Cu) mg/l, Max	0.05	1.5	-
16	Fluoride (as F) mg/l, Max	1.0	1.5	-
17	Free residual Chlorine, mg/l, Min	0.2	1	To be applicable only when water is chlorinated. Tested at consumer end. When protection against viral infection is required, it should be minimum 0.5 mg/l
18	Iron (as Fe) mg/l, max	0.3	No relaxation	Total concentration of manganese (as Mn) and iron (as Fe) shall not exceed 0.3mg/l
19	Magnesium (as Mg) mg/l, Max	30	100	-
20	Manganese (as Mn) mg/l, Max	0.1	0.3	-
21	Mineral oil, mg/l Max	0.5	No relaxation	-
22	Nitrate (as NO ₃) mg/l, Max	45	No relaxation	-
23	Phenolic compounds (as C ₆ H ₅ OH) mg/l, Max	0.001	0.002	-
24	Selenium (as Se), mg/l, Max	0.01	No relaxation	-
25	Silver (as Ag), mg/l, Max	0.1	No relaxation	-
26	Sulphate (as SO ₄) mg/l, Max	200	400	May be extended to 400 provided that Magnesium does not exceed 30

S. No.	Characteristic	Requirement (Acceptable Limit)	Permissible limit in the absence of alternate source	Remarks
27	Sulphide (as H ₂ S) mg/l, max	0.05	No relaxation	-
28	Total alkalinity as calcium carbonate, mg/l Max	200	600	-
29	Total Hardness (as CaCO ₃) mg/l, Max	200	600	-
30	Zinc (as zn), mg/l, Max	5	15	-
31	Cadmium (as Cd), mg/l, Max	0.003	No relaxation	-
32	Cyanide (as CN), mg/l, Max	0.05	No relaxation	-
33	Lead (as Pb), mg/l, Max	0.01	No relaxation	-
34	Mercury (as Hg) mg/l, Max	0.001	No relaxation	-
35	Molybdenum (as Mo) mg/l, max	0.07	No relaxation	-
36	Nickle (as Ni), mg/l, max	0.02	No relaxation	-
37	Polychlorinated biphenyls, mg/l, max	0.0005	No relaxation	-
38	Polynuclear aromatic hydrocarbons (as PAH) mg/l, Max	0.0001	No relaxation	-
39	Total Arsenic (as As), mg/l, Max	0.01	0.05	-
40	Total Chromium (as Cr) mg/l, Max	0.05	No relaxation	-
41	Trihalomethanes Bromoform, mg/l, max Dibromochloromethane, mg/l, max Bromodichloromethane, mg/l, max Chloroform, mg/l, max	0.1 0.1 0.06 0.2	No relaxation No relaxation No relaxation No relaxation	-
42	Radioactive materials a) Alpha emitters Bq/l max b) Beta emitters pci/l, Max	0.1 1.0	No relaxation No relaxation	-

Monitoring Plans for Environment Condition

For each of the environmental components, the monitoring plan specifies the parameters to be monitored; location of the monitoring sites; frequency and duration of monitoring. The monitoring plan also specifies the applicable standards, implementation and supervising responsibilities. The monitoring plan for the various environmental condition indicators of the project in construction and operation stages is presented in **Table 1.3**.

Monitoring plan does not include the requirement of arising out of Regulation Provision such as obtaining NOC/ consent for plant site operation.

Table 1.3: Environmental Monitoring Plan

Attribute	Project Stage	Parameter	Standards	Frequency	Duration	Location	Implementation
Air	Construction	CO, NO _x , PM10, PM2.5, and SO ₂	Air (prevention and Control of Pollution) Rules, CPCB, 1994	24 hourly sampling once in a season for three season in a year Three seasons (Winter, Summer and Post Monsoon)	Construction Period	Along the road (1. Arni, 2. Aagaram, 3. Chetpet, 4. Valathy, 5. Kudali, 6. Gingee, 7. Arasalpuram, 8. Thambur, 9. Pappankulam Hot mix Plant	EMU-TNRSP
	Operation			24 hourly sampling once in a season for three season in a year for two years Three seasons (Winter, Summer and Post Monsoon)			
Water	Construction	All essential characteristics and some of desirable characteristics as decided by	Indian Standards for Inland Surface Waters (IS: 2296, 1982) and for Drinking Water (IS : 10500 - 2012)	One grab sampling once in a season for three seasons in a year	Construction Period	Along the road (1. Laxminagar, 2. Chetpet, 3. Valathy, 4. Ashokapuri)	EMU-TNRSP

Attribute	Project Stage	Parameter	Standards	Frequency	Duration	Location	Implementation
	Operation	the Environmental Specialist of the PMC and TNRSP		One grab sampling once in a season for three seasons in a year for 2 years	2 Years	Along the road (1. Laxminagar, 2. Chtpet, 3. Valathy, 4. Ashokapuri)	EMU-TNRSP
Noise	Construction	Noise levels on dB (A) scale	MoEF Noise Rules, 2000	Hourly sampling for one day once in a season for three season in a year	Construction Period	Along the road (1. Arni, 2. Aagaram, 3. Chetpet, 4. Valathy, 5. Kudali, 6. Gingee, 7. Arasalpuram, 8. Thambur, 9. Pappankulam Hot mix Plant	EMU-TNRSP
	Operation			Hourly sampling for one day once in a season for three season in a year for two years		2 Years	Along the road (1. Arni, 2. Aagaram, 3. Chetpet, 4. Valathy, 5. Kudali, 6. Gingee, 7. Arasalpuram, 8. Thambur, 9. Pappankulam

Attribute	Project Stage	Parameter	Standards	Frequency	Duration	Location	Implementation
Soil	Construction	Monitoring of Pb, SAR and Oil & Grease	Threshold for each contaminant set by IRIS database of USEPA until national standards are promulgated	One grab sampling once in a season for three seasons in a year	Construction Period	Along the road (1. Laxminagar, 2. Chtpet, 3. Valathy, 4. Ashokapuri) Hot mix Plant	EMU-TNRSP
	Operation			One grab sampling once in a season for three seasons in a year for 2 years		2 Years	Along the road (1. Laxminagar, 2. Chtpet, 3. Valathy, 4. Ashokapuri)
Borrow area	Construction	As per Guidelines	-	Once in a month	-	Borrow area location	Contractor
Tree plantation	Operation stage	As per Rehabilitation Plan		Quarterly	-	Areas where plantation is being done	EMU-TNRSP

ENVIRONMENTAL MONITORING LOCATIONS

In addition of the critical locations selected during design stage, the environmental monitoring will also be done at the construction camp site and plant site during construction stage. List of critical locations for carrying out monitoring is presented in **chapter 4 of EIA report: Baseline environment.**

REPORTING PROCEDURES

Mitigation and enhancement measures adopted in the final design have been identified in the contract documents and Bill of quantities so that performance and completion is effective. The periodic site visits of the EO/Engineer/EE of the PU will keep a record of progress as well as the site-specific EMP implementation records. The frequent meeting of the EO/Engineer with the Contractors will ensure any information and communication gap with regard to the Construction phase environmental management at construction site; labour and construction camps quarry and borrow areas etc. It is necessary that the EO/Engineer should visit the sites for evolving a concept for the Environmental Management with regard to the siting of various construction requirements. The various reporting guidelines and arrangements are presented in **TABLE 1.4. DESIRED MONITORING AND REPORTING PROCESS AND RESPONSIBILITIES.**

TABLE 1.4: DESIRED MONITORING AND REPORTING PROCESS AND RESPONSIBILITIES

Format No.	Item	Stage	Contractor	PMC Consultant		PIU-TNRSP		Reporting from TNRSP to World Bank)
			Implementation and Reporting to TA Consultant	Supervision	Reporting to TNRSP	Oversee Field Compliance Monitoring	Reporting to EMU, TNRSP	
P1	Identification for disposal locations	Pre -construction	One Time	One Time	One Time	One Time	One Time	One Time
P2	Setting up of Construction Camp	Pre- construction	One Time	One Time	One Time	One Time	One Time	One Time
P3	Establishment of Borrow areas	Pre- construction	Monthly	Monthly	Quarterly	Quarterly	Quarterly	Quarterly
P4	Establishment of HMP/ BMP	Before start of construction	One Time	One Time	One Time	One Time	One Time	One Time
P5	Road Safety and Traffic Management	Pre- construction	Monthly	Monthly	Monthly	Monthly	Quarterly	Quarterly
P6	Arrangement for Temporary Land	Pre- Construction	Monthly	Monthly	Monthly	Quarterly	Quarterly	Quarterly
P7	Pollution Monitoring	Pre- Construction	Quarterly	During Monitoring	Immediately on receipt of results	Quarterly	Quarterly	Quarterly
P8	Tree cutting/Stump Removal	During construction period	Monthly	Monthly	Monthly	Quarterly	Quarterly	Quarterly
P9	Identification of Source of water for Construction	Pre- construction	One Time	One Time	One Time	One Time	One Time	One Time
C1	Details of earth work	During Construction period	Monthly	Monthly	Monthly	Quarterly	Quarterly	Quarterly
C2	Details of Hot Mix Plant	During Construction period	Monthly	Monthly	Monthly	Quarterly	Quarterly	Quarterly
C3	Details of landfill locations/	During Construction period	Monthly	Monthly	Monthly	Quarterly	Quarterly	Quarterly
C4	Details of Machinery in Operations	During Construction period	Monthly	Monthly	Monthly	Quarterly	Quarterly	Quarterly
C5	Redevelopment of borrow areas	During construction period	Monthly	Monthly	Monthly	Quarterly	Half Yearly	Quarterly

Format No.	Item	Stage	Contractor	PMC Consultant		PIU-TNRSP		Reporting from TNRSP to World Bank)
			Implementation and Reporting to TA Consultant	Supervision	Reporting to TNRSP	Oversee Field Compliance Monitoring	Reporting to EMU, TNRSP	
C6	Safety Check List	During construction period	Monthly	Monthly	Monthly	Quarterly	Half Yearly	Quarterly
C7	Accident Report	During construction period	After Accident	After Accident	Immediately on receipt of report	Quarterly	Half Yearly	Quarterly
C8	Pollution Monitoring	During construction period	Quarterly	During Monitoring	Quarterly	Quarterly	Quarterly	Quarterly
C9	Enhancement Measures	During Construction	Monthly	Monthly	Monthly	Quarterly	Quarterly	Quarterly
C10	Restoration of Construction Sites	Immediate after Construction	One Time	One Time	One Time	One Time	One Time	Quarterly
O1	Pollution Monitoring	During Operation	-	-	-	Quarterly	Quarterly	Quarterly